

THIS DRAWING IS UNPUBLISHED. RELEASED FOR PUBLICATION
 © COPYRIGHT - ALL RIGHTS RESERVED.

LOC H DIST -

REVISIONS

P	LTR	DESCRIPTION	DATE	DWN	APVD
	S4	PACKAGING BLISTER MATERIAL CHANGE	08MAY2015	NV	PS

REFERENCE MATING INTERFACE PATTERN:
 1,27 STAGGERED PITCH x 1,5 ROW-DISTANCE.

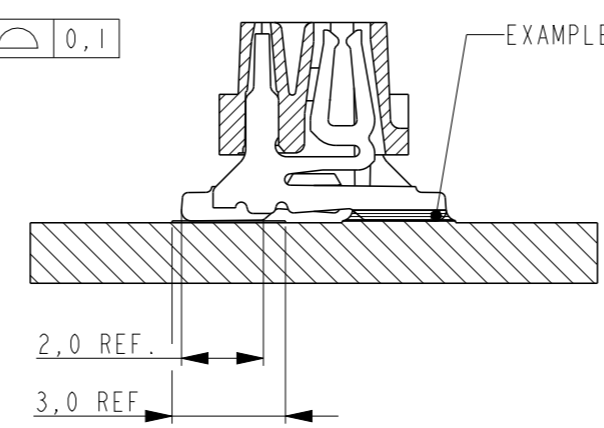
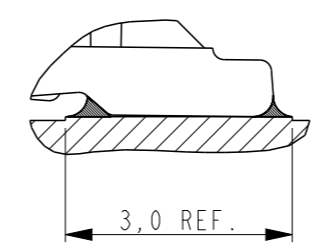
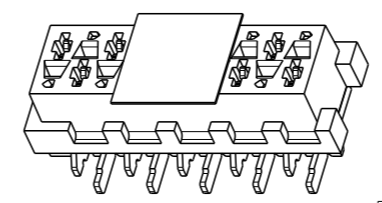
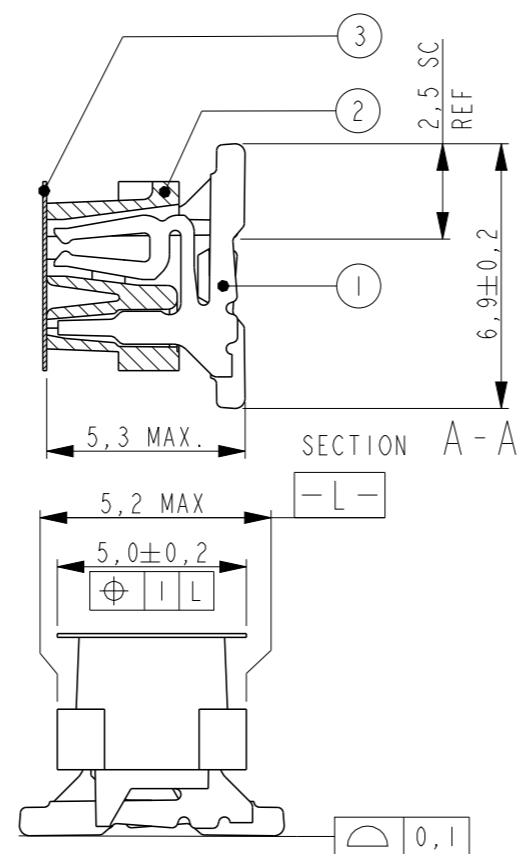
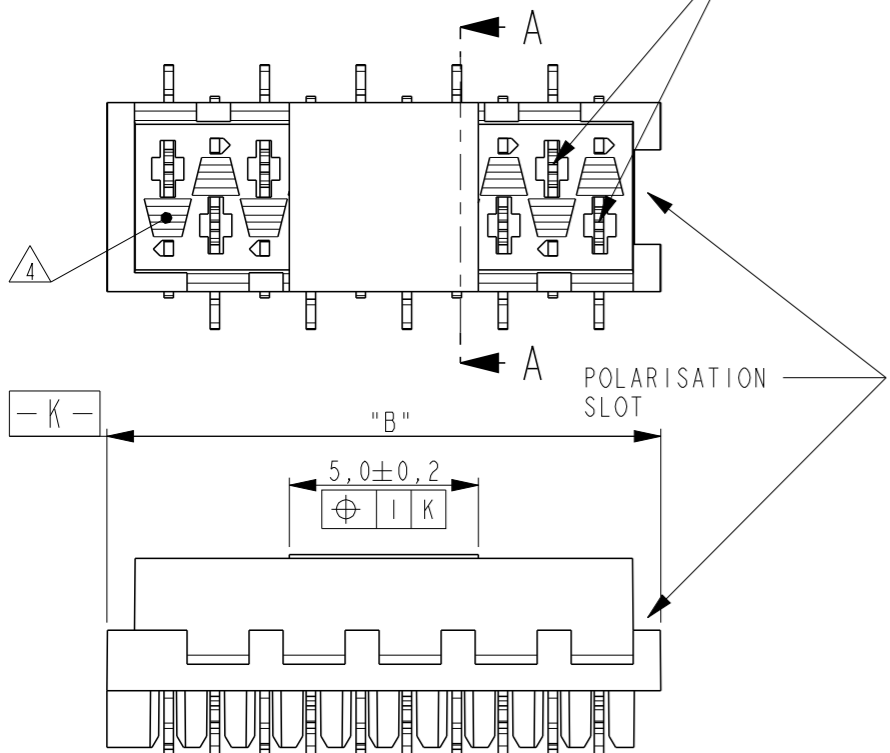

PART NUMBER VAC. TAPE. ¹	PART REV	PART NUMBER ³	PART REV	NR. OF POS. "n"	"A"	"B" MAX.
7-188275-4	U	0-188275-4	U	4	3,81	7,1
7-188275-6	U	0-188275-6	U	6	6,35	9,7
7-188275-8	U	0-188275-8	U	8	8,89	12,2
8-188275-0	U	1-188275-0	U	10	11,43	14,7
8-188275-2	U	1-188275-2	U	12	13,97	17,3
8-188275-4	U	1-188275-4	U	14	16,51	19,8
8-188275-6	U	1-188275-6	U	16	19,05	22,4
8-188275-8	V	1-188275-8	V	18	21,59	24,9
9-188275-0	U	2-188275-0	U	20	24,13	27,5

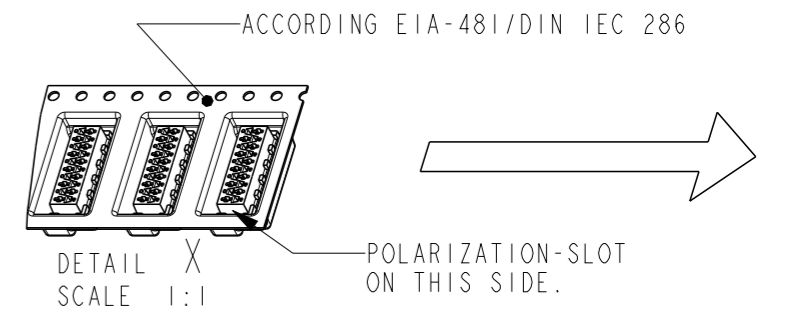
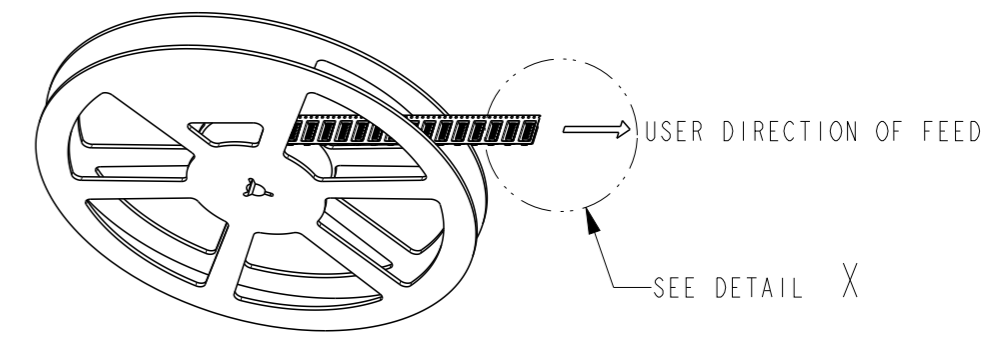
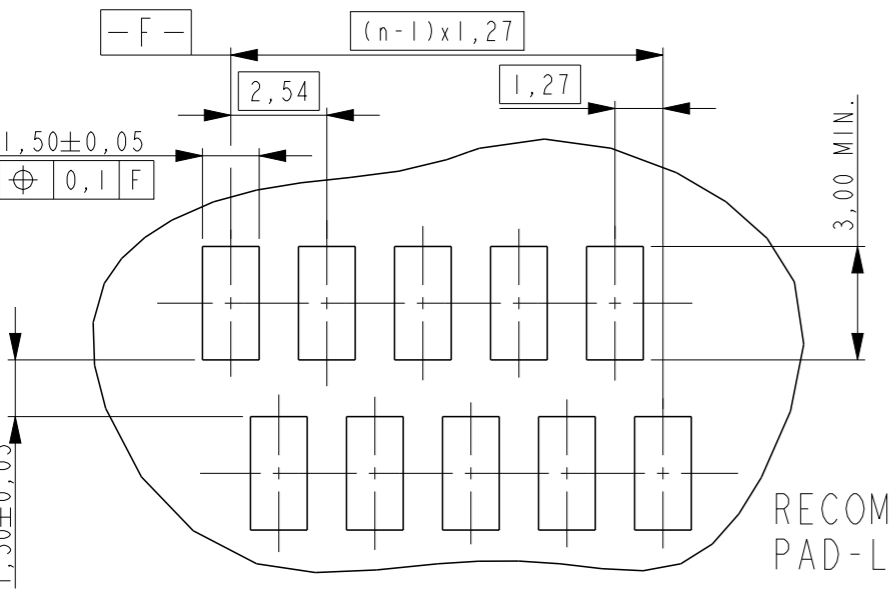
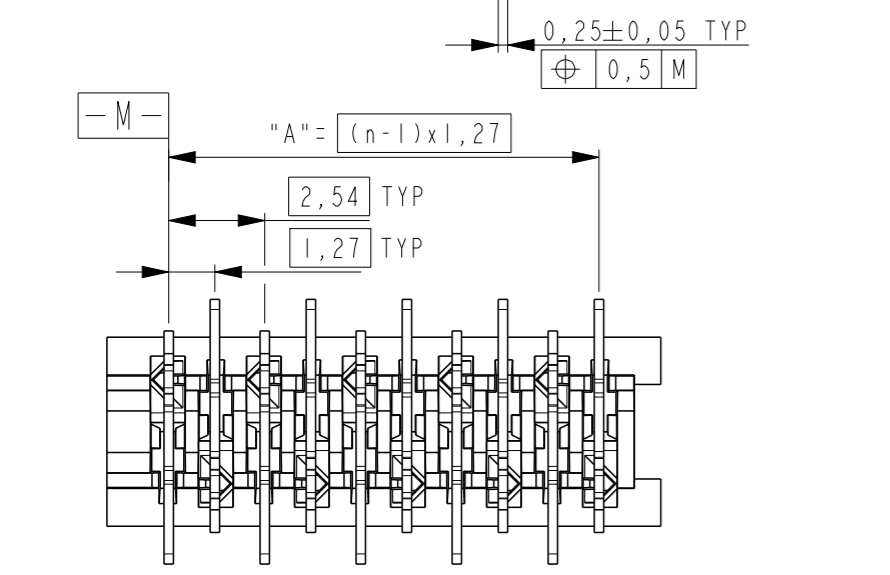

NOTES:

- 1 TAPE FOR VACUUM P&P ONLY FOR DASHNUMBERS 7- /8- /9-
- 2 FOR PACKAGING SEE SHEET 2 OF 2
- 3 WITHOUT VACUUM TAPE.
- 4 CORING-OUTS FOR MANUFACTURING PURPOSE ONLY. SHAPE MAY VARY, BUT IS NOT FUNCTIONAL FOR THE APPLICATION.
- 5 SHOWN IS A 10 POSITION CONNECTOR.

ITEM NO.	COMPONENT DESCRIPTION	MATERIAL	FINISH / COLOR
3	PICK & PLACE TAPE	KAPTON	AMBER TRANSPARENT
2	FEMALE HOUSING	POLYAMIDE 4/6,GF	RED
1	FEMALE CONTACT	PHOSPHOR BRONZE	TIN OVER NICKEL

THIS DRAWING IS A CONTROLLED DOCUMENT.		DWN M. GOSSELINK	
DIMENSIONS: mm		CHK -	
TOLERANCES UNLESS OTHERWISE SPECIFIED:		APVD -	
0 PLC	±-	PRODUCT SPEC	108-19052
1 PLC	±-	APPLICATION SPEC	114-13318
2 PLC	±-	WEIGHT	-
3 PLC	±-		
4 PLC	±-		
ANGLES	±-		
FINISH	SEE TABLE		
MATERIAL	SEE TABLE		

THIS DRAWING IS A CONTROLLED DOCUMENT.

STE TE Connectivity

CONNECTOR, FEMALE-ON-BOARD TOP-ENTRY, SMD, Micro-MatCh

SIZE	CAGE CODE	DRAWING NO	RESTRICTED TO
A3	00779	C-188275	-

CUSTOMER DRAWING SCALE 5:1 SHEET 1 OF 2 REV S4

THIS DRAWING IS UNPUBLISHED.

RELEASED FOR PUBLICATION

© COPYRIGHT -

ALL RIGHTS RESERVED.

LOC
H

DIST
-

REVISIONS

P LTR

DESCRIPTION

DATE

DWN

APVD

SEE SHEET 1

TAPE WIDTH 24 mm

TAPE WIDTH 44 mm

TAPE WIDTH 44 mm

TAPE WIDTH 44 mm

TAPE WIDTH 44 mm

TAPE WIDTH 44 mm

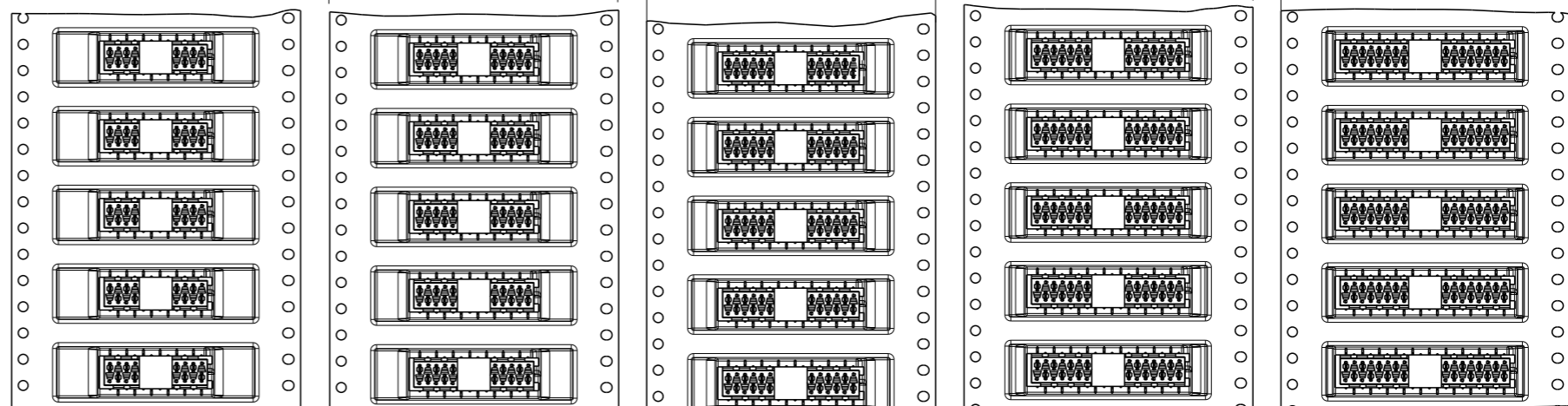
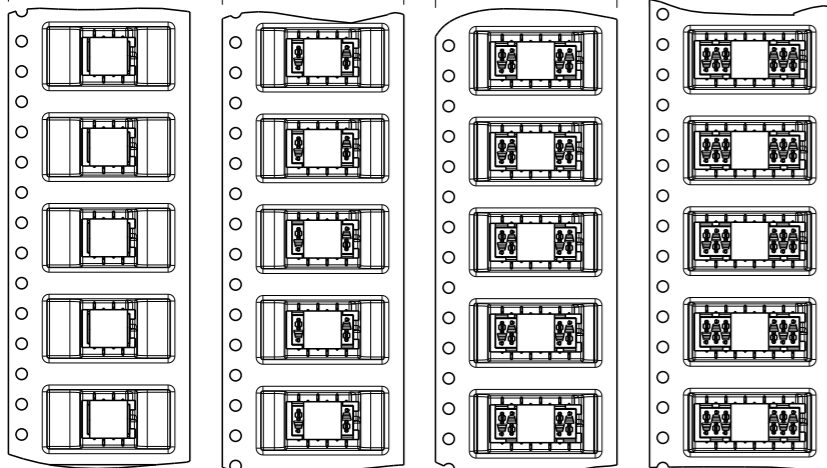

7-188275-4	7-188275-6	7-188275-8	8-188275-0
4 POSITION	6 POSITION	8 POSITION	10 POSITION
0-188275-4	0-188275-6	0-188275-8	1-188275-0

8-188275-2	8-188275-4	8-188275-6	8-188275-8	9-188275-0
12 POSITION	14 POSITION	16 POSITION	18 POSITION	20 POSITION
1-188275-2	1-188275-4	1-188275-6	1-188275-8	2-188275-0

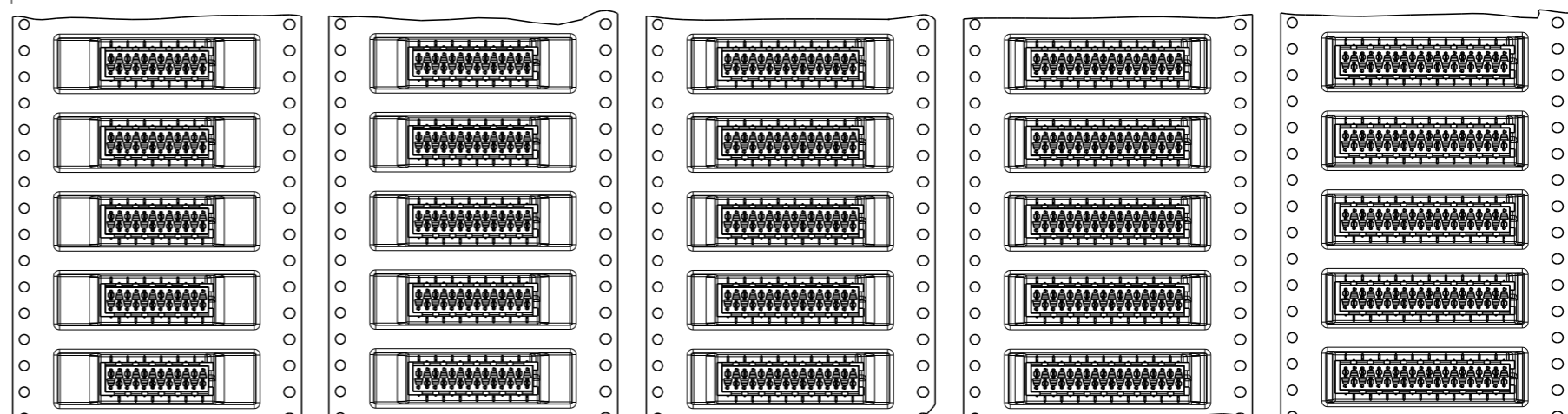
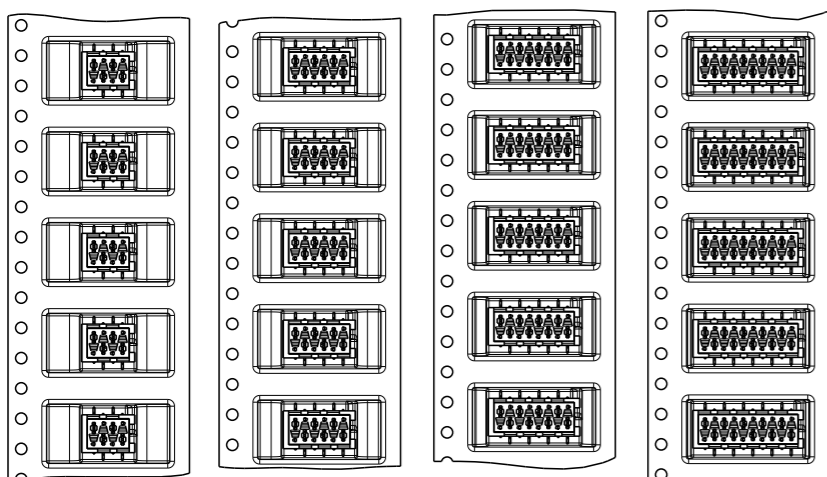

THIS DRAWING IS A CONTROLLED DOCUMENT.

DWN
M. GOSSELINK
CHK
-
APVD
-
PRODUCT SPEC
108-19052
APPLICATION SPEC
114-13318
WEIGHT
-



CONNECTOR, FEMALE-ON-BOARD TOP-ENTRY, SMD, Micro-MaTch

DIMENSIONS:
mm

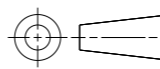

TOLERANCES UNLESS OTHERWISE SPECIFIED:

0 PLC	±-
1 PLC	±0.1
2 PLC	±0.05
3 PLC	±-
4 PLC	±-
ANGLES	±-
FINISH	-

MATERIAL -

NAME
-
SIZE
A3
CAGE CODE
00779
DRAWING NO
C-188275
RESTRICTED TO
-

CUSTOMER DRAWING

SCALE 1:1 SHEET 2 OF 2 REV S4

X-ON Electronics

Largest Supplier of Electrical and Electronic Components

Click to view similar products for [Board to Board & Mezzanine Connectors](#) category:

Click to view products by [TE Connectivity](#) manufacturer:

Other Similar products are found below :

[589158040000018](#) [MDF7C-18P-2.54DSA\(55\)](#) [FCN-230C068-11](#) [FCN-268F012-G/BD](#) [FCN-268F036-G/BD](#) [FCN-268M012-G/0D](#) [FCN-268M024-G/1D](#) [FCN-723J004/1](#) [MIS-048-01-F-D-DP-K](#) [832-10-034-10-001000](#) [FX4C-80S-1.27DSA](#) [FCN-214Q030-G/0](#) [FCN-234P048-G/0](#) [FCN-235D050-G/C](#) [210-93-314-41-105000](#) [2-22603-0](#) [MDF7-40DP-2.54DSA\(55\)](#) [AXG720047](#) [5031084030](#) [MIT-114-03-F-D-K](#) [55323-1519](#) [DF33-2P-3.3DSA\(24\)](#) [YFT-20-05-H-03-SB-K](#) [503308-3040](#) [026-6203-PDB](#) [027-6203-PDB](#) [069159702701000](#) [10123981-102LF](#) [101A10019X](#) [55650-0588-C](#) [68682-310LF](#) [68684-306](#) [75140-7012](#) [87471-650](#) [194261-1](#) [FCN-268F024-G0D](#) [10124054-515LF](#) [68685-603](#) [8-1616154-3](#) [MIS-019-01-F-D](#) [541371078](#) [IL-WX-10PB-HF-B-E1000E](#) [FCN-268M024-G/3D](#) [20021832-06016C1LF](#) [KX15-20KLDL-E1000E](#) [MDF7-16DP-2.54DSA\(55\)](#) [AXE810124](#) [FCN-214J100-G/0](#) [FCN-230C068-E/S](#) [AXE812124](#)