

THIS DRAWING IS UNPUBLISHED. RELEASED FOR PUBLICATION. ALL RIGHTS RESERVED.

| LOC |     | DIST        |                 | REVISIONS |      |           |      |    |
|-----|-----|-------------|-----------------|-----------|------|-----------|------|----|
| P   | LTR | DESCRIPTION |                 |           | DATE | DWN       | APVD |    |
| -   | -   | A           | INITIAL RELEASE |           |      | 08AUG2014 | PS   | JK |

REFERENCE MATING INTERFACE PATTERN:  
1,27 STAGGERED PITCH x 1,5 ROW-DISTANCE.

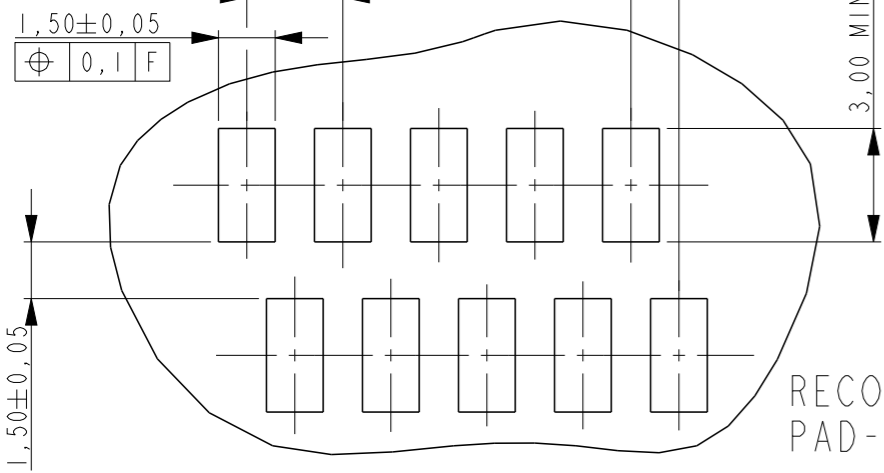
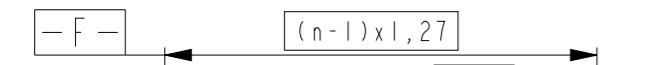
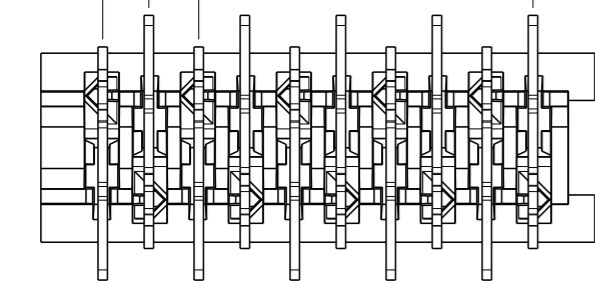
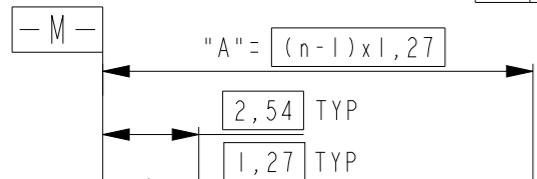
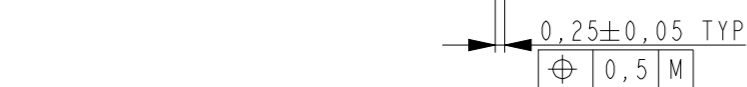
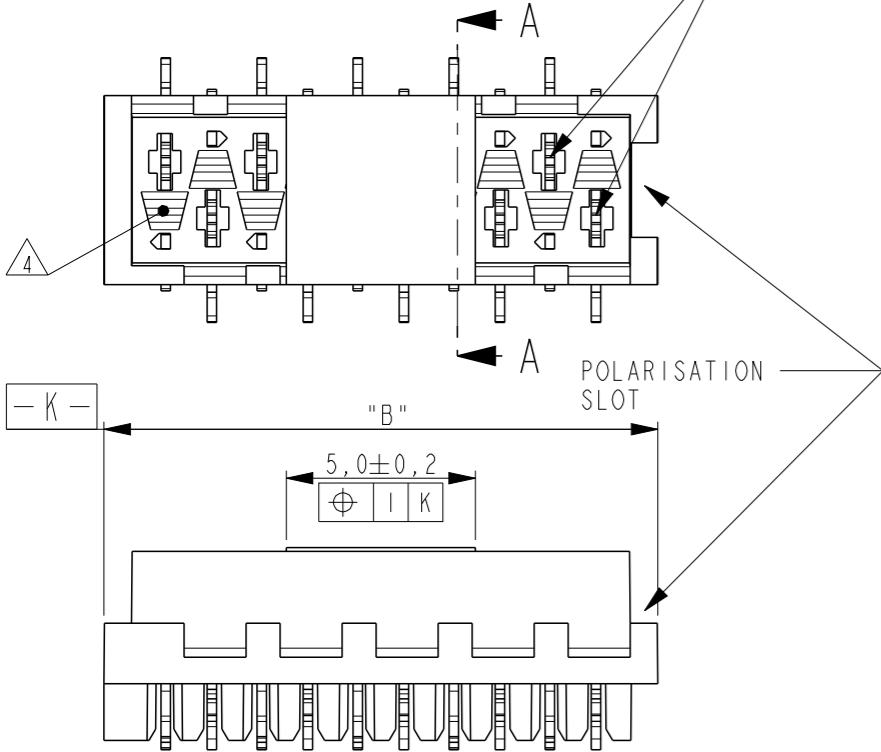

RECOMMENDED PC-BOARD  
PAD-LAYOUT TOP VIEW

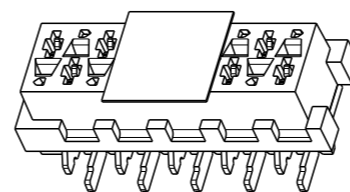
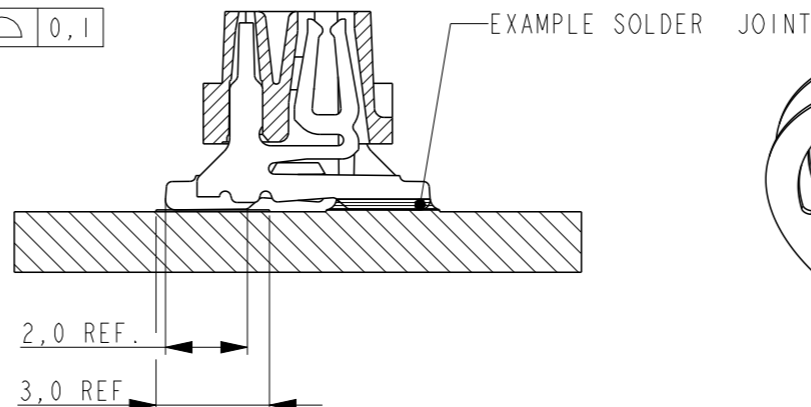
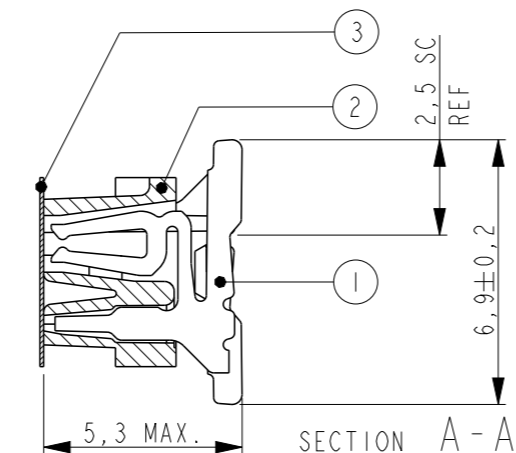

SCALE 3:1

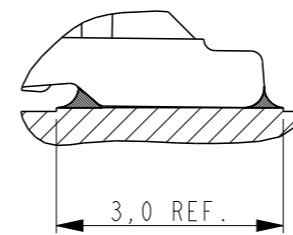

SOLDER DETAIL  
SCALE 10:1

| 1 | PARTNUMBER<br>VAC. TAPE. | 3 | PARTNUMBER  | NO. OF<br>POS. "n" | "A"   | "B" MAX. |
|---|--------------------------|---|-------------|--------------------|-------|----------|
|   | 7-2178711-4              |   | 2178711-4   | 4                  | 3,81  | 7,1      |
|   | 7-2178711-6              |   | 2178711-6   | 6                  | 6,35  | 9,7      |
|   | 7-2178711-8              |   | 2178711-8   | 8                  | 8,89  | 12,2     |
|   | 8-2178711-0              |   | 1-2178711-0 | 10                 | 11,43 | 14,7     |
|   | 8-2178711-2              |   | 1-2178711-2 | 12                 | 13,97 | 17,3     |
|   | 8-2178711-4              |   | 1-2178711-4 | 14                 | 16,51 | 19,8     |
|   | 8-2178711-6              |   | 1-2178711-6 | 16                 | 19,05 | 22,4     |
|   | 8-2178711-8              |   | 1-2178711-8 | 18                 | 21,59 | 24,9     |
|   | 9-2178711-0              |   | 2-2178711-0 | 20                 | 24,13 | 27,5     |

NOTES:

- 1 TAPE FOR VACUUM P&P ONLY FOR DASHNUMBERS 7- /8- /9-
- 2 FOR PACKAGING SEE SHEET 2 OF 2
- 3 WITHOUT VACUUM TAPE.
- 4 CORING-OUTS FOR MANUFACTURING PURPOSE ONLY.  
SHAPE MAY VARY, BUT IS NOT FUNCTIONAL FOR THE APPLICATION.
- 5 SHOWN IS A 10 POSITION CONNECTOR.

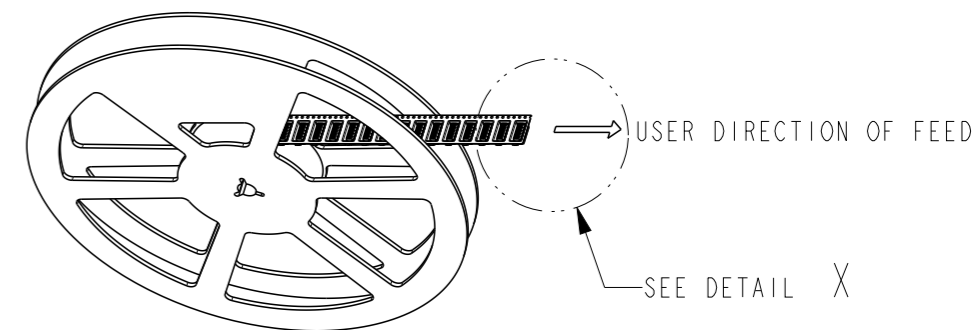

ACCORDING EIA-481/DIN IEC 286

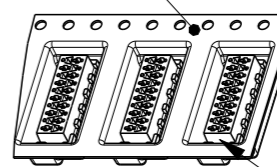

DETAIL X  
SCALE 1:1  
POLARIZATION-SLOT  
ON THIS SIDE.

| ITEM NO. | COMPONENT DESCRIPTION | MATERIAL         | FINISH / COLOR                    |
|----------|-----------------------|------------------|-----------------------------------|
| 3        | PICK & PLACE TAPE     | KAPTON           | AMBER TRANSPARENT                 |
| 2        | FEMALE HOUSING        | POLYAMIDE 4/6,GF | BLACK                             |
| 1        | FEMALE CONTACT        | TIN BRASS        | 3.0 - 5.0µm TIN OVER 0.5µm NICKEL |

|  |           |                                 |  |         |               |
|--|-----------|---------------------------------|--|---------|---------------|
| THIS DRAWING IS A CONTROLLED DOCUMENT.   |           | DWN 30JUL2014<br>PRASHANTH      | TE Connectivity<br>Micro-MaTch VALUE LINE<br>FEMALE-ON-BOARD, TOP ENTRY,<br>SMD, CONNECTOR |         |               |
| DIMENSIONS:<br>mm  |           | CHK 05AUG2014<br>PRASHANTH      |  |         | NAME          |
| TOLERANCES UNLESS OTHERWISE SPECIFIED:   |           | APVD 05AUG2014<br>JAYANTH KUMAR |  |         | PRODUCT SPEC  |
| 0 PLC ±-<br>1 PLC ±-<br>2 PLC ±-<br>3 PLC ±-<br>4 PLC ±-<br>ANGLES ±-<br>FINISH ±- |           | APPLICATION SPEC                |  |         | RESTRICTED TO |
| MATERIAL   | SEE TABLE | WEIGHT                          | -  | SIZE A3 |               |
| CUSTOMER DRAWING   |           | SCALE 5:1                       | SHEET 1 OF 2   | REV A   |               |

THIS DRAWING IS UNPUBLISHED.

RELEASED FOR PUBLICATION

© COPYRIGHT -

ALL RIGHTS RESERVED.

| LOC | DIST | REVISIONS |     |             |      |     |      |
|-----|------|-----------|-----|-------------|------|-----|------|
|     |      | P         | LTR | DESCRIPTION | DATE | DWN | APVD |
| -   | -    |           |     | SEE SHEET 1 |      |     |      |

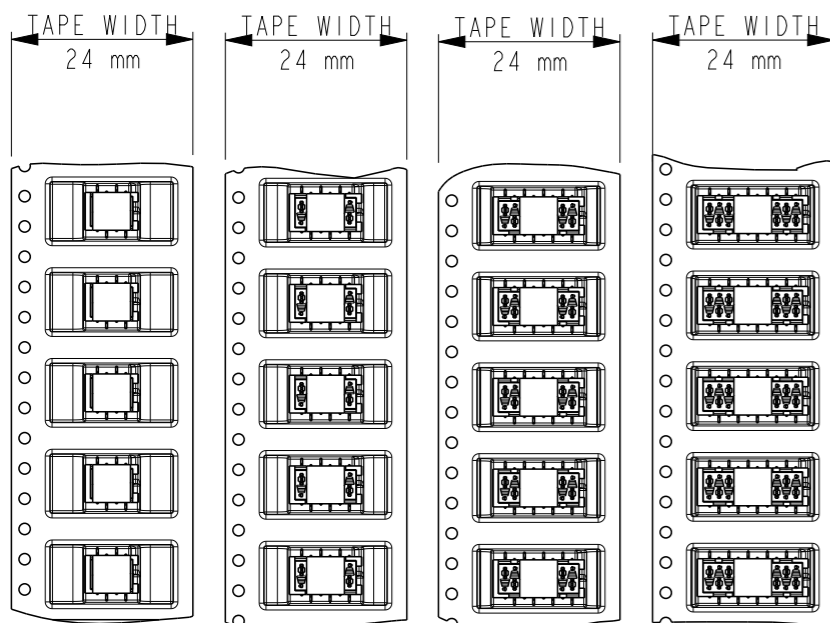

|             |             |             |             |
|-------------|-------------|-------------|-------------|
| 7-2178711-4 | 7-2178711-6 | 7-2178711-8 | 8-2178711-0 |
| 4 POSITION  | 6 POSITION  | 8 POSITION  | 10 POSITION |
| 2178711-4   | 2178711-6   | 2178711-8   | 1-2178711-0 |

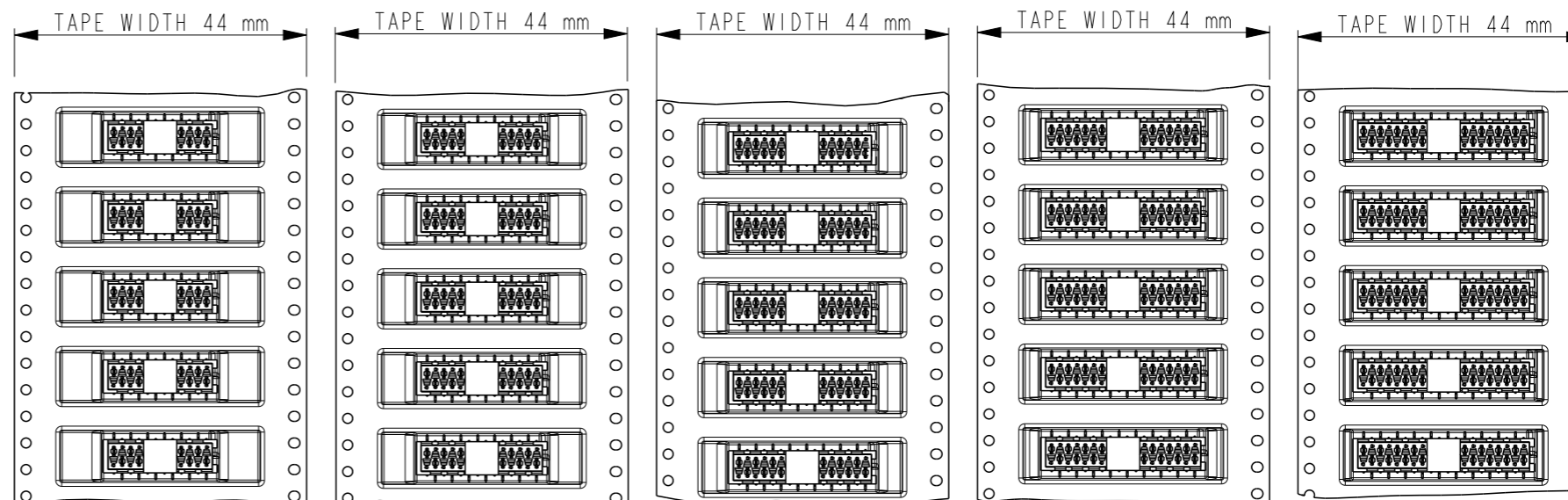
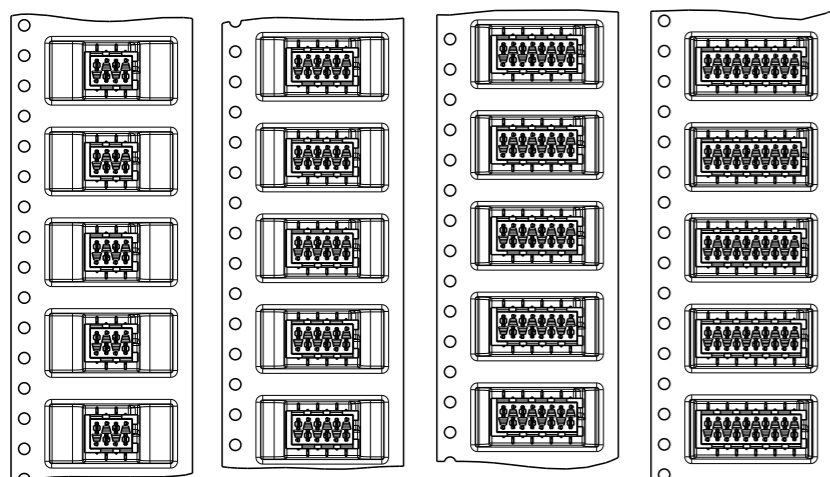

|             |             |             |             |             |
|-------------|-------------|-------------|-------------|-------------|
| 8-2178711-2 | 8-2178711-4 | 8-2178711-6 | 8-2178711-8 | 9-2178711-0 |
| 12 POSITION | 14 POSITION | 16 POSITION | 18 POSITION | 20 POSITION |
| 1-2178711-2 | 1-2178711-4 | 1-2178711-6 | 1-2178711-8 | 2-2178711-0 |

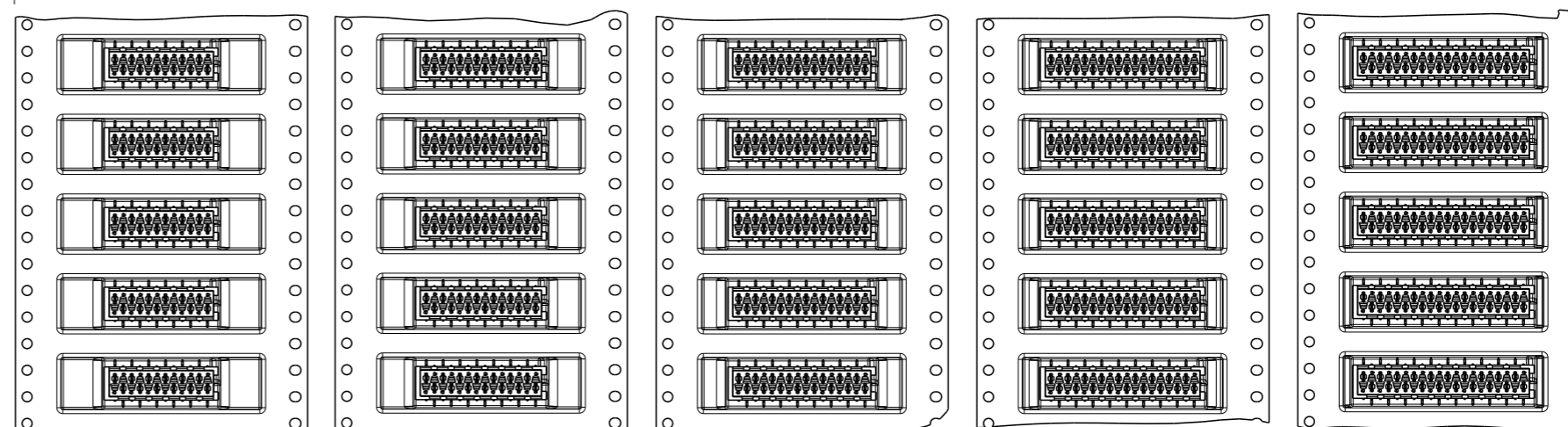

THIS DRAWING IS A CONTROLLED DOCUMENT.

DIMENSIONS:  
mm

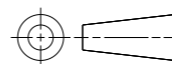

TOLERANCES UNLESS OTHERWISE SPECIFIED:

- 0 PLC ±-
- 1 PLC ±0.1
- 2 PLC ±0.05
- 3 PLC ±-
- 4 PLC ±-
- ANGLES ±-
- FINISH -

MATERIAL -

DWN 25JUL2014  
PRASHANTH  
CHK 05AUG2014  
PRASHANTH  
APVD 05AUG2014  
JAYANTH KUMAR  
PRODUCT SPEC  
108-32087  
APPLICATION SPEC  
114-13318  
WEIGHT -

CUSTOMER DRAWING



NAME  
Micro-MaTch VALUE LINE  
FEMALE-ON-BOARD, TOP ENTRY,  
SMD, CONNECTOR

|      |           |            |               |
|------|-----------|------------|---------------|
| SIZE | CAGE CODE | DRAWING NO | RESTRICTED TO |
| A3   | 00779     | ©-2178711  | -             |

SCALE 1:1 SHEET 2 OF 2 REV A

## X-ON Electronics

Largest Supplier of Electrical and Electronic Components

*Click to view similar products for [Headers & Wire Housings](#) category:*

*Click to view products by [TE Connectivity](#) manufacturer:*

Other Similar products are found below :

[892-18-020-10-001101](#) [58102-G61-06LF](#) [582553-1](#) [0009485154](#) [009176003701906](#) [0050291907](#) [LY20-4P-DT1-P1E-BR](#) [02.125.8002.8](#)  
[609-3404](#) [61062-3](#) [61082-181009](#) [622-3653LF](#) [63453-116](#) [636-1030](#) [636-1427](#) [636-3427](#) [636-4007](#) [641938-9](#) [641991-4](#) [644827-2](#) [65817-](#)  
[010LF](#) [65817-015LF](#) [65863-015LF](#) [66207-023LF](#) [67095-007LF](#) [67601157](#) [68645-018](#) [68648-049](#) [70.362.1628.0](#) [70-4210](#) [70-4226B](#) [70-](#)  
[4853B](#) [707-5020](#) [707-5028](#) [71.350.2428.0](#) [71918-208LF](#) [71961-016LF](#) [733-134](#) [733-162](#) [754199-000](#) [760-3052](#) [787-8014-00](#) [79531-3000](#)  
[FCN-360C032-B](#) [FCN-367T-T012/H](#) [FCN-723D010/2](#) [80.063.4001.1](#) [800-90-001-10-001000](#) [800-90-010-10-002000](#) [801-43-002-10-013000](#)