

| REVISIONS | | | | | |
|-----------|------|---------------------------|-----------|------|-------|
| P. | LTN. | DESCRIPTION | DATE | DMN. | APVD. |
| C | | REVISED PER ECO-15-017333 | 29DEC2015 | DD | DS |
| D | | REVISED PER ECO-16-006990 | 16MAY2016 | DD | DS |
| D1 | | REVISED PER ECO-17-007878 | 31MAY2017 | JM | DS |
| E | | REVISED PER ECO-18-019884 | 19DEC2018 | DS | DS |

- MATERIAL: HOUSING - UL94V-0 PBT
 LOCKING WEDGE - UL94V-0 PBT, RED
 COVER - UL94V-0 PBT, BLACK
 MATING SEAL - SILICONE
 WIRE SEAL - SILICONE
- HOUSING COLORS ARE MECHANICALLY KEYED TO MATE WITH IDENTICALLY COLORED HEADER ASSEMBLIES.
- PLUG USES REELED TERMINAL 770520 OR LOOSE PIECE TERMINAL 770854.
- DATE CODE ON THIS SURFACE. USES 5 DIGIT CODE: FIRST 2 DIGITS = YEAR, SECOND 2 DIGITS = WEEK, LAST DIGIT = DAY.
- CIRCUITS 3, 7, 16, 17, 21, 22 BLOCKED
- OPTIONAL VOID CORING ON 35 POSITION PLUG ASSEMBLY 776164.

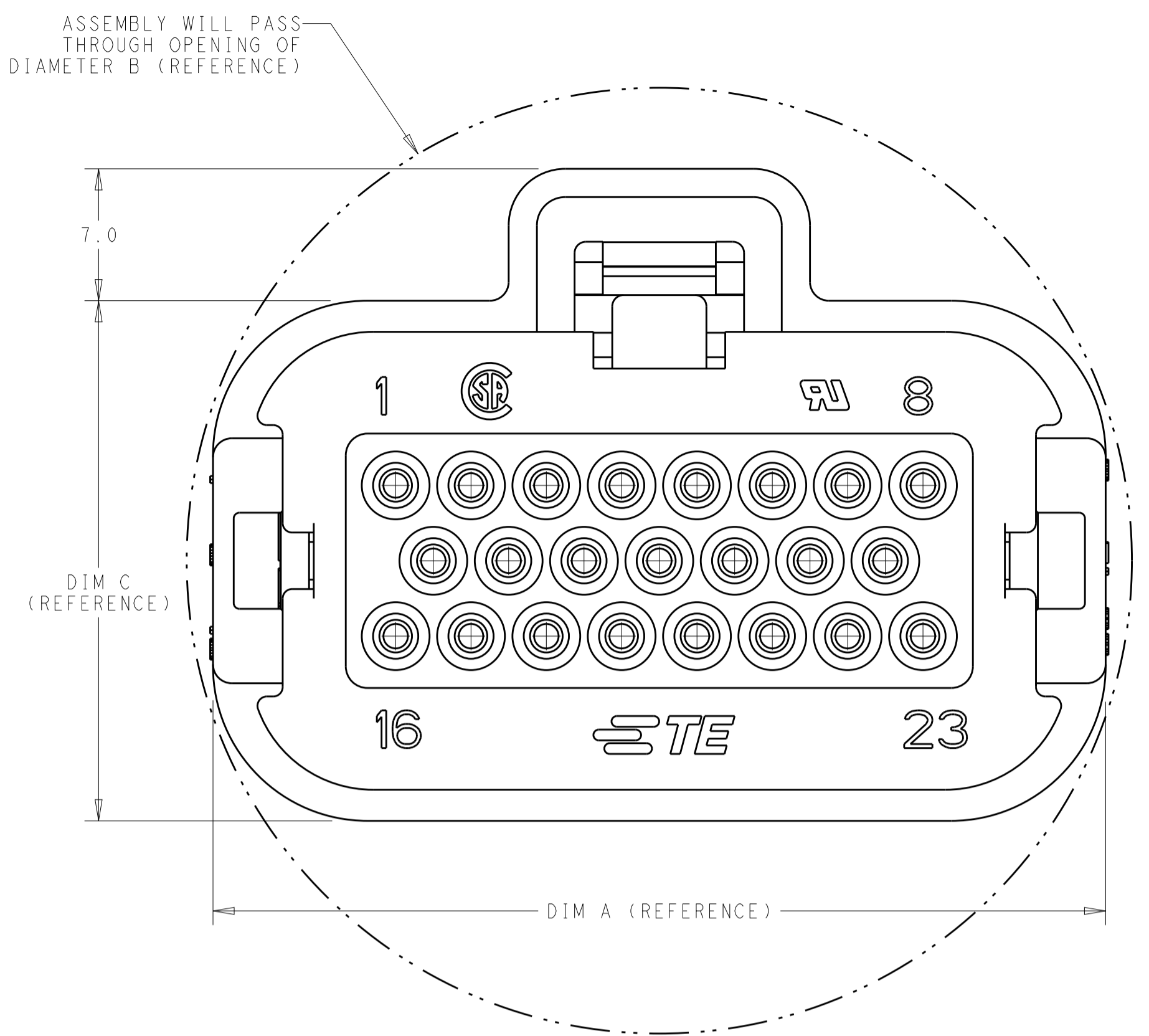
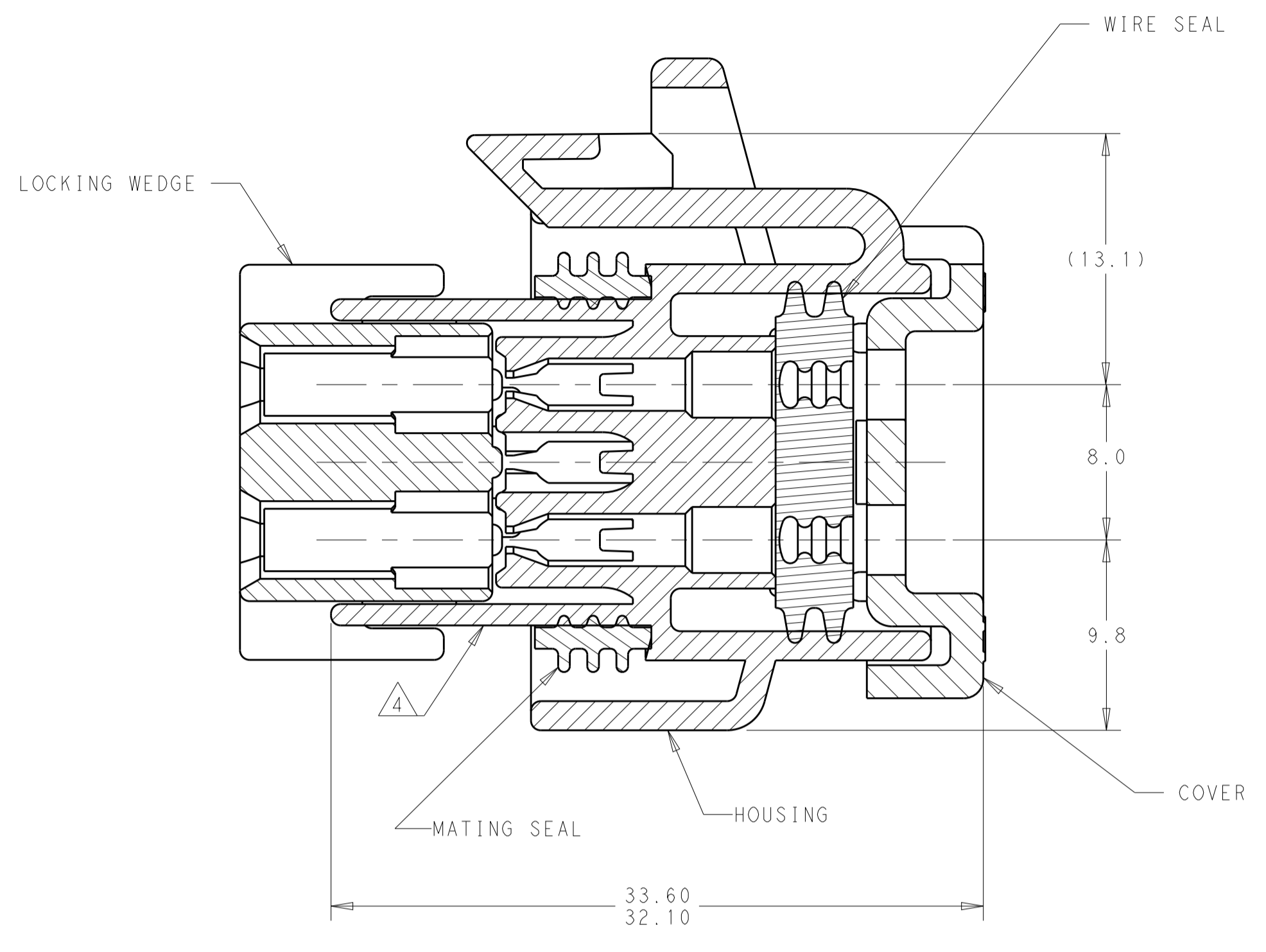

23-POSITION CONNECTOR SHOWN, SEE TABLE BELOW FOR ALTERNATE DIMENSIONS.

| CONNECTOR SIZE | A | B | C |
|----------------|------|----|-------|
| 8-POSITION | 27.4 | 40 | 27.50 |
| 14-POSITION | 35.4 | 44 | 27.60 |
| 23-POSITION | 47.4 | 50 | 27.60 |
| 35-POSITION | 63.4 | 66 | 27.45 |

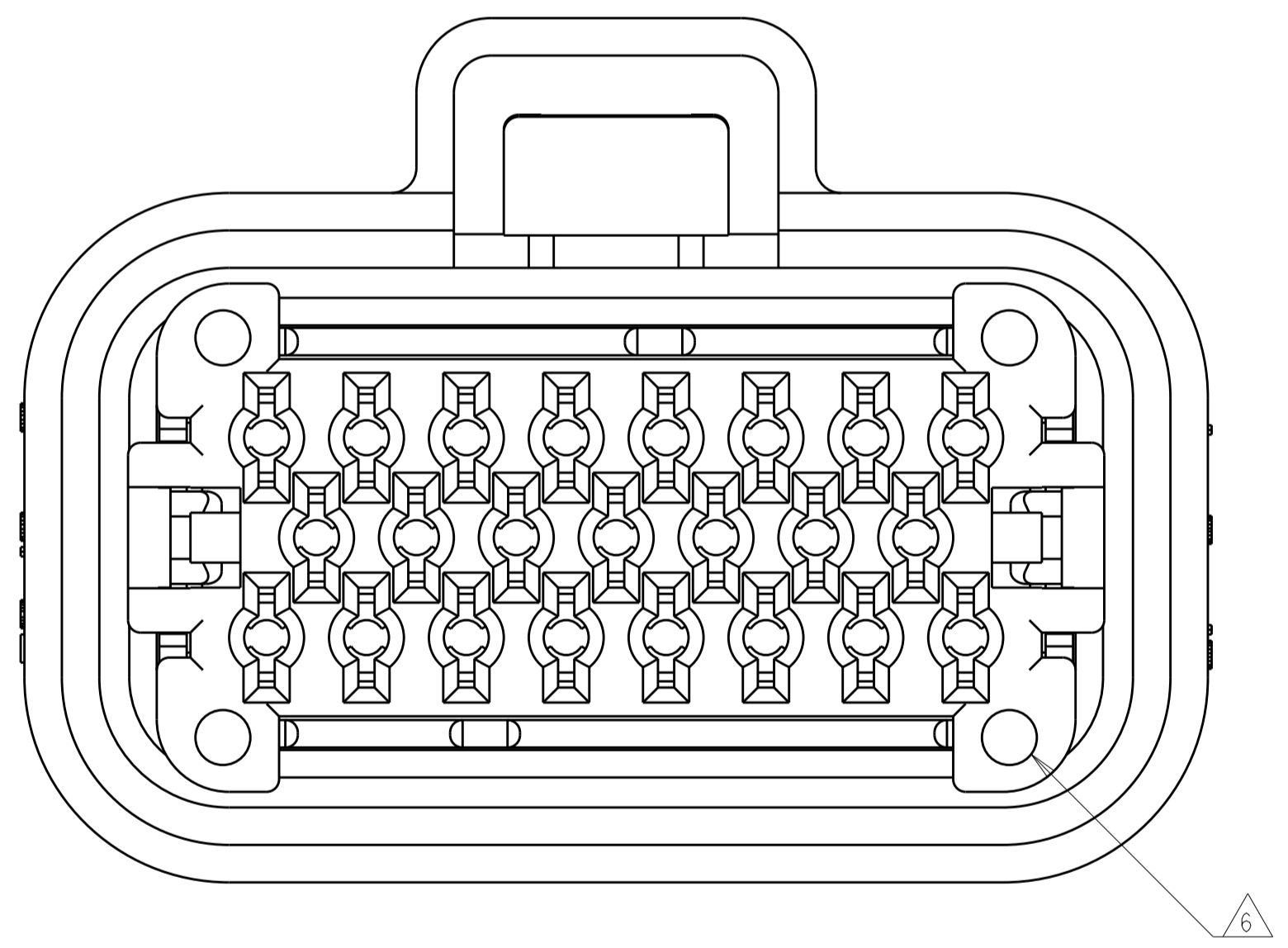

BOTTOM VIEW WITH LOCKING WEDGE

| MATING HEADER | RIGHT-ANGLE | WIRE SEAL COLOR | MATING SEAL COLOR | HOUSING COLOR | NO. OF POSITIONS | PART NUMBER |
|----------------|----------------|-----------------|-------------------|---------------|------------------|-------------|
| 776230, 776231 | 776180, 776163 | RED | RED | ORANGE | 35-POSITION | 776164-6 |
| | | | | BLUE | | 776164-5 |
| | | | | GREY | | 776164-4 |
| | | | | NATURAL | | 776164-2 |
| 776200, 776228 | 770669, 776087 | GREEN | RED | BLACK | 23-POSITION | 776164-1 |
| | | | | BLUE | | 770680-5 |
| | | | | GREY | | 770680-4 |
| | | | | BLACK | | 770680-3 |
| 776261, 776262 | 776266, 776267 | GREEN | GREEN | NATURAL | 14-POSITION | 770680-2 |
| | | | | BLACK | | 770680-1 |
| | | | | BLUE | | 776273-5 |
| | | | | GREY | | 776273-4 |
| 776275, 776276 | 776279, 776280 | YELLOW | YELLOW | NATURAL | 8-POSITION | 776273-2 |
| | | | | BLACK | | 776273-1 |
| | | | | BLACK | | 776286-2 |
| | | | | BLACK | | 776286-1 |

THIS DRAWING IS A CONTROLLED DOCUMENT.

DMN: A. MARTIN 11JUN2015
 CHK: D. STRAUSSER 29JUN2015
 APVD: G. BROWN 29JUN2015

TE Connectivity

NAME: PLUG ASSEMBLY, AMPSEAL FAMILY DRAWING

PRODUCT SPEC: 108-1329
 APPLICATION SPEC: 114-16016

SIZE: A1
 CAGE CODE: 2293782
 DRAWING NO: 2293782

RESTRICTED TO: -

SCALE: 4:1 SHEET 1 OF 2 REV E

| REVISIONS | | | | |
|-----------|-----|-------------|------|------|
| P. | LTN | DESCRIPTION | DATE | APVD |
| - | - | SEE SHEET 1 | - | - |
| | | | | |
| | | | | |

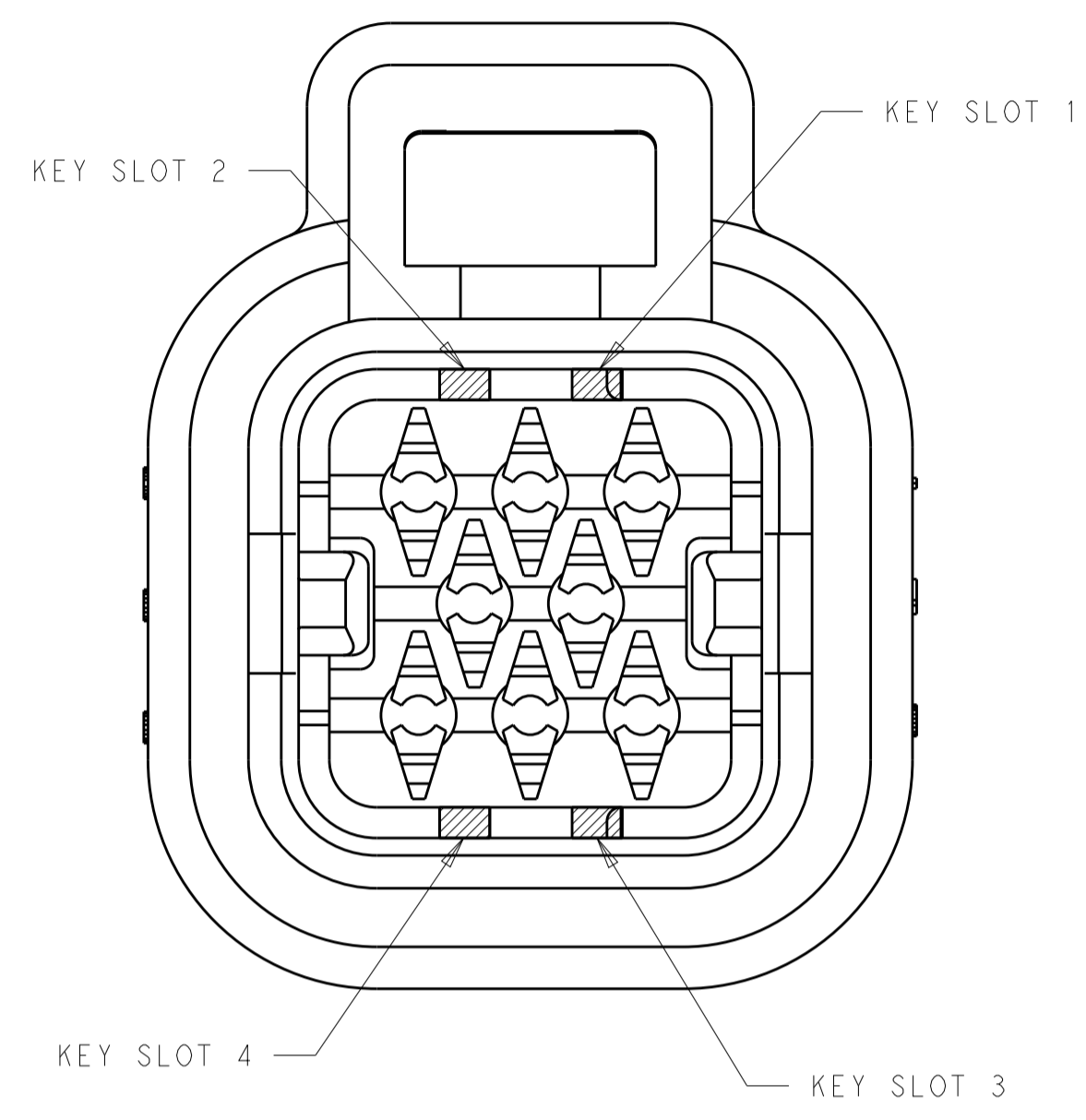

| KEY SLOT LOCATION (SEE VIEW ABOVE) | COLOR | PART NUMBER |
|------------------------------------|---------|-------------|
| 1 & 3 | NATURAL | 776286-2 |
| 2 & 4 | BLACK | 776286-1 |

8-POSITION CONNECTOR
 KEY SLOT LOCATIONS
 SCALE 4:1

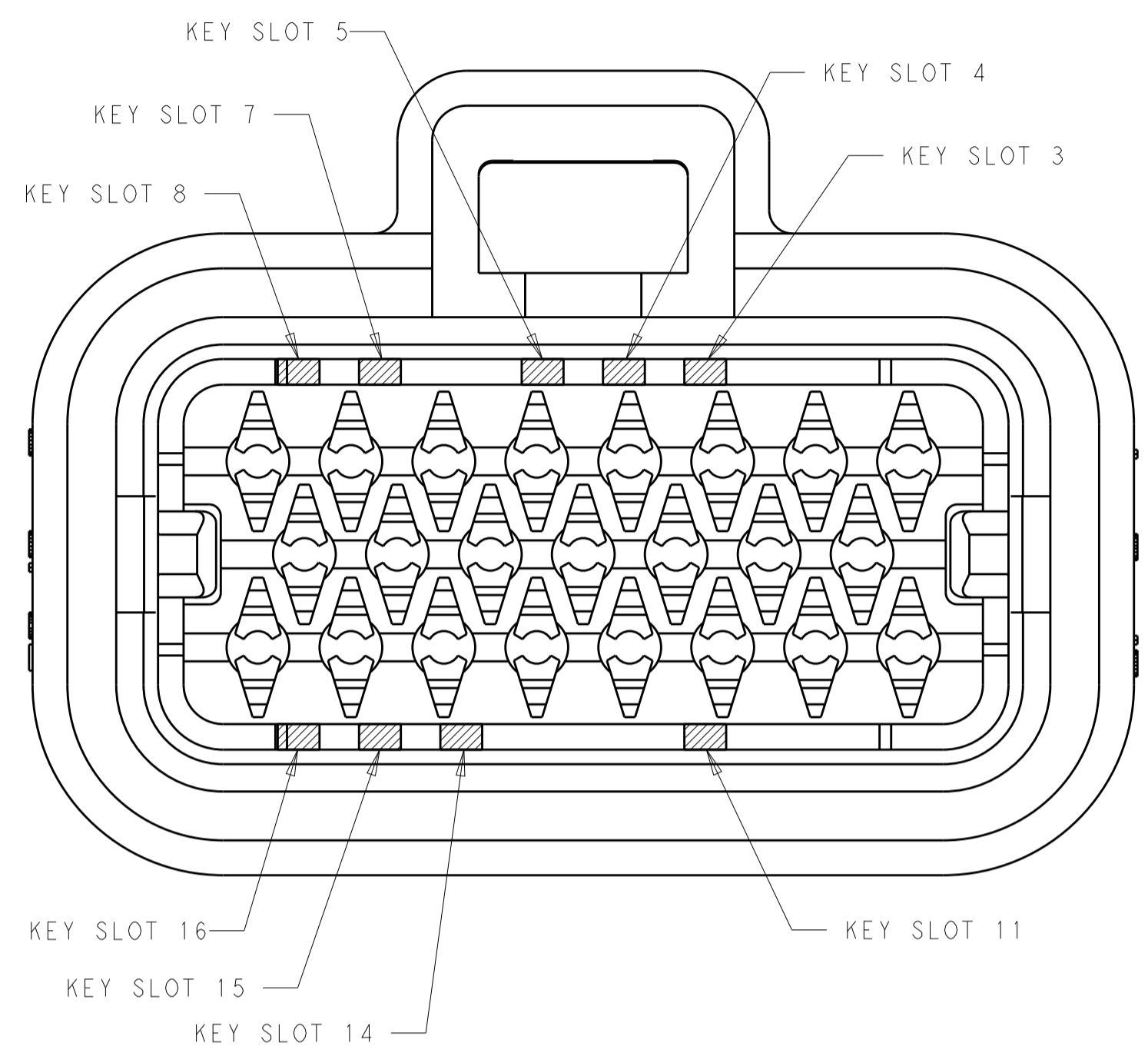

| KEY SLOT LOCATION (SEE VIEW ABOVE) | COLOR | PART NUMBER |
|------------------------------------|---------|-------------|
| 3, 8 & 16 | BLUE | 770680-5 |
| 7 & 15 | GREY | 770680-4 |
| 4 & 14 | BLACK | 770680-3 |
| 5 & 11 | NATURAL | 770680-2 |
| 4 & 14 | BLACK | 770680-1 |

23-POSITION CONNECTOR
 KEY SLOT LOCATIONS
 SCALE 4:1

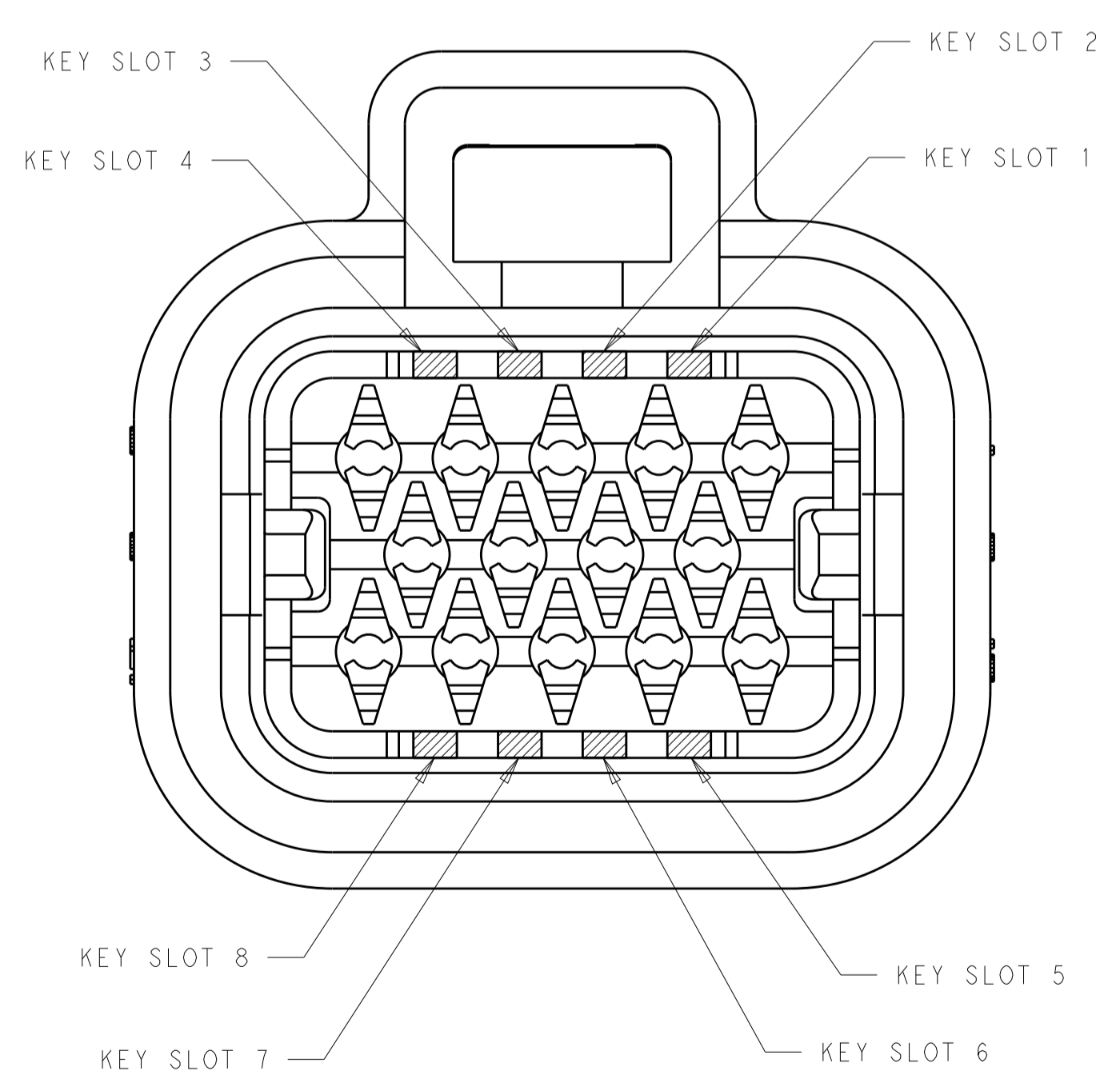

| KEY SLOT LOCATION (SEE VIEW ABOVE) | COLOR | PART NUMBER |
|------------------------------------|---------|-------------|
| 3 & 5 | BLUE | 776273-5 |
| 2 & 8 | GREY | 776273-4 |
| 1 & 6 | NATURAL | 776273-2 |
| 3 & 7 | BLACK | 776273-1 |

14-POSITION CONNECTOR
 KEY SLOT LOCATIONS
 SCALE 4:1

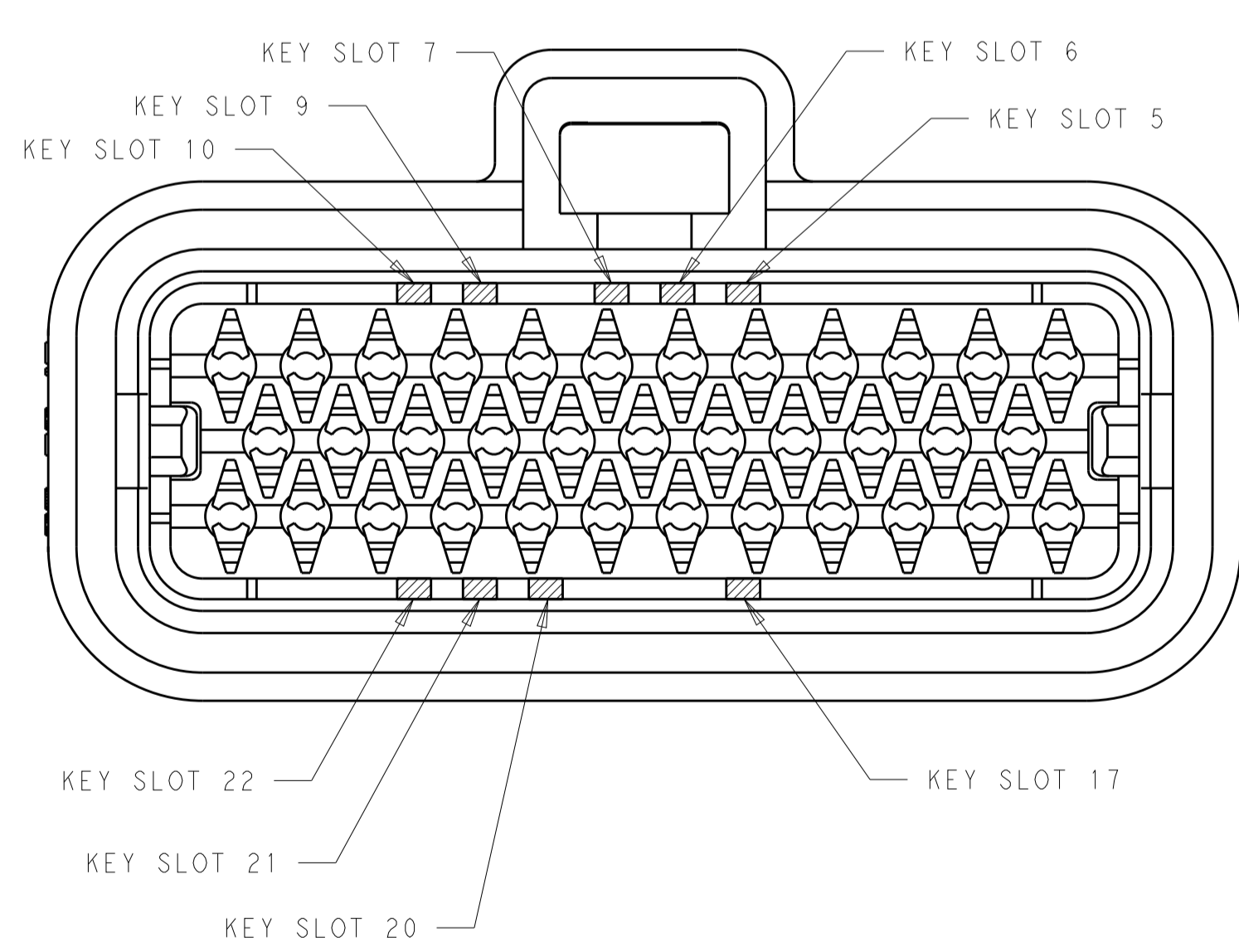

| KEY SLOT LOCATION (SEE VIEW ABOVE) | COLOR | PART NUMBER |
|------------------------------------|---------|-------------|
| 7 & 22 | ORANGE | 776164-6 |
| 5, 10, 22 | BLUE | 776164-5 |
| 9 & 21 | GREY | 776164-4 |
| 7 & 17 | NATURAL | 776164-2 |
| 6 & 20 | BLACK | 776164-1 |

35-POSITION CONNECTOR
 KEY SLOT LOCATIONS
 SCALE 3:1

| | | | |
|--|--|--|--|
| THIS DRAWING IS A CONTROLLED DOCUMENT. | | DWN: A. MARTIN 11JUN2015 CHK: D. STRAUSSER 29JUN2015 APVD: G. BROWN 29JUN2015 | TE Connectivity NAME: PLUG ASSEMBLY, AMPSEAL FAMILY DRAWING |
| DIMENSIONS: mm | TOLERANCES UNLESS OTHERWISE SPECIFIED: 0 PLC ± 1 PLC ±0.2 2 PLC ± 3 PLC ± 4 PLC ± ANGLES ± | PRODUCT SPEC: 108-1329 APPLICATION SPEC: 114-16016 WEIGHT: - CUSTOMER DRAWING | |
| MATERIAL: - SEE NOTE 1 | FINISH: - | SIZE: A1 CAGE CODE: 00779 DRAWING NO: C=2293782 SCALE: 1:1 SHEET: 2 OF 2 REV: E | RESTRICTED TO: - |

X-ON Electronics

Largest Supplier of Electrical and Electronic Components

Click to view similar products for [Automotive Connectors](#) category:

Click to view products by [TE Connectivity](#) manufacturer:

Other Similar products are found below :

[003-018-000](#) [60403001](#) [60993906-B](#) [M902-2131](#) [M902-2161](#) [M902-2344](#) [72.330.1035.1](#) [73.353.4028.0](#) [F119300-B](#) [F166900](#) [F258300-B](#)
[F358300-B](#) [F407400](#) [F444110](#) [F487000](#) [F509500B-B](#) [827153-1](#) [8N1515-32-24P](#) [9-1326729-8](#) [925474-1](#) [928905-1](#) [964562-4](#) [968782-1](#)
[GT17SA-8DS-HU](#) [98891-1012](#) [98947-1016](#) [12004147](#) [12004475-L](#) [12010290](#) [12010309-B](#) [12015454](#) [12020219-B](#) [12041318-B](#) [12052225-](#)
[L](#) [12052466](#) [12064869](#) [12004327-B](#) [12015308](#) [12015384](#) [12015909](#) [1-21030-1](#) [12041254](#) [12041318](#) [12047946-B](#) [12047957](#) [12047957-L](#)
[12059473](#) [12066261](#) [12110546](#) [12110546-B](#)