

REVISIONS					
P.	LTN.	DESCRIPTION	DATE	DWN.	APVD.
C		REVISED PER ECO-15-017333	29DEC2015	DD	DS
D		REVISED PER ECO-16-006990	16MAY2016	DD	DS
D1		REVISED PER ECO-17-007878	31MAY2017	JM	DS
E		REVISED PER ECO-18-019884	19DEC2018	DS	DS

- MATERIAL: HOUSING - UL94V-0 PBT  
 LOCKING WEDGE - UL94V-0 PBT, RED  
 COVER - UL94V-0 PBT, BLACK  
 MATING SEAL - SILICONE  
 WIRE SEAL - SILICONE
- HOUSING COLORS ARE MECHANICALLY KEYED TO MATE WITH IDENTICALLY COLORED HEADER ASSEMBLIES.
- PLUG USES REELED TERMINAL 770520 OR LOOSE PIECE TERMINAL 770854.
- DATE CODE ON THIS SURFACE. USES 5 DIGIT CODE: FIRST 2 DIGITS = YEAR, SECOND 2 DIGITS = WEEK, LAST DIGIT = DAY.
- CIRCUITS 3, 7, 16, 17, 21, 22 BLOCKED
- OPTIONAL VOID CORING ON 35 POSITION PLUG ASSEMBLY 776164.

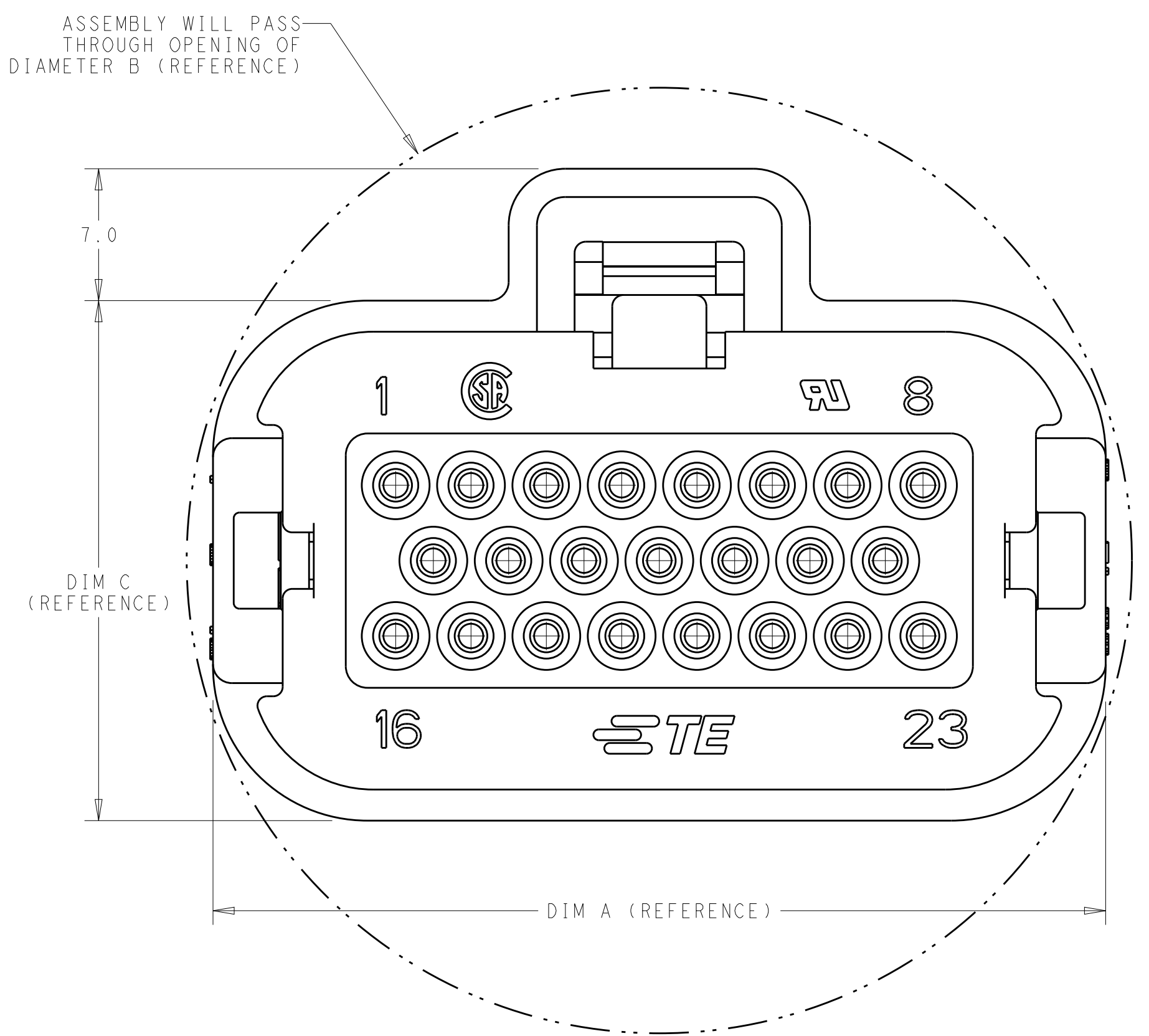
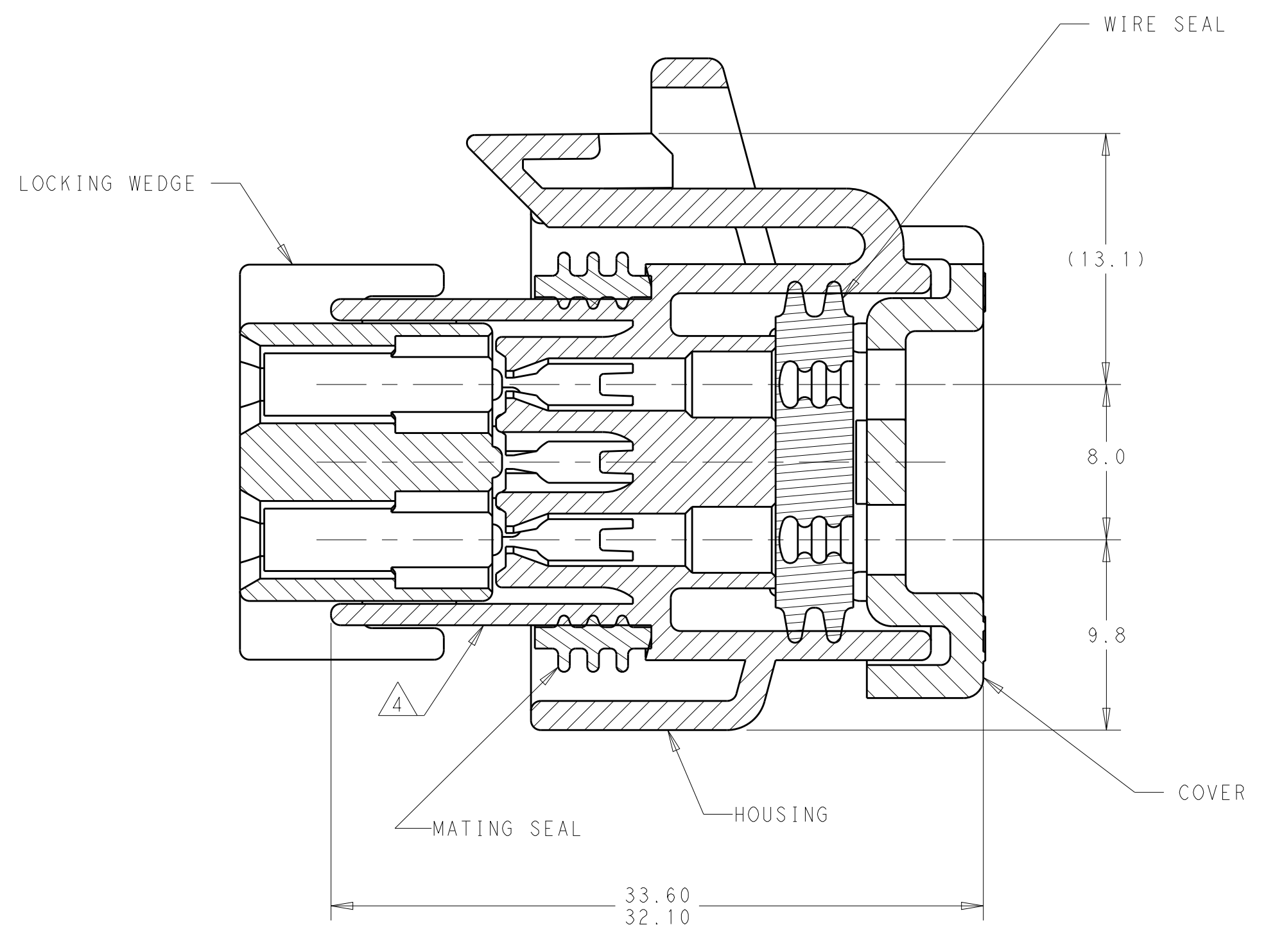

23-POSITION CONNECTOR SHOWN, SEE TABLE BELOW FOR ALTERNATE DIMENSIONS.

CONNECTOR SIZE	A	B	C
8-POSITION	27.4	40	27.50
14-POSITION	35.4	44	27.60
23-POSITION	47.4	50	27.60
35-POSITION	63.4	66	27.45

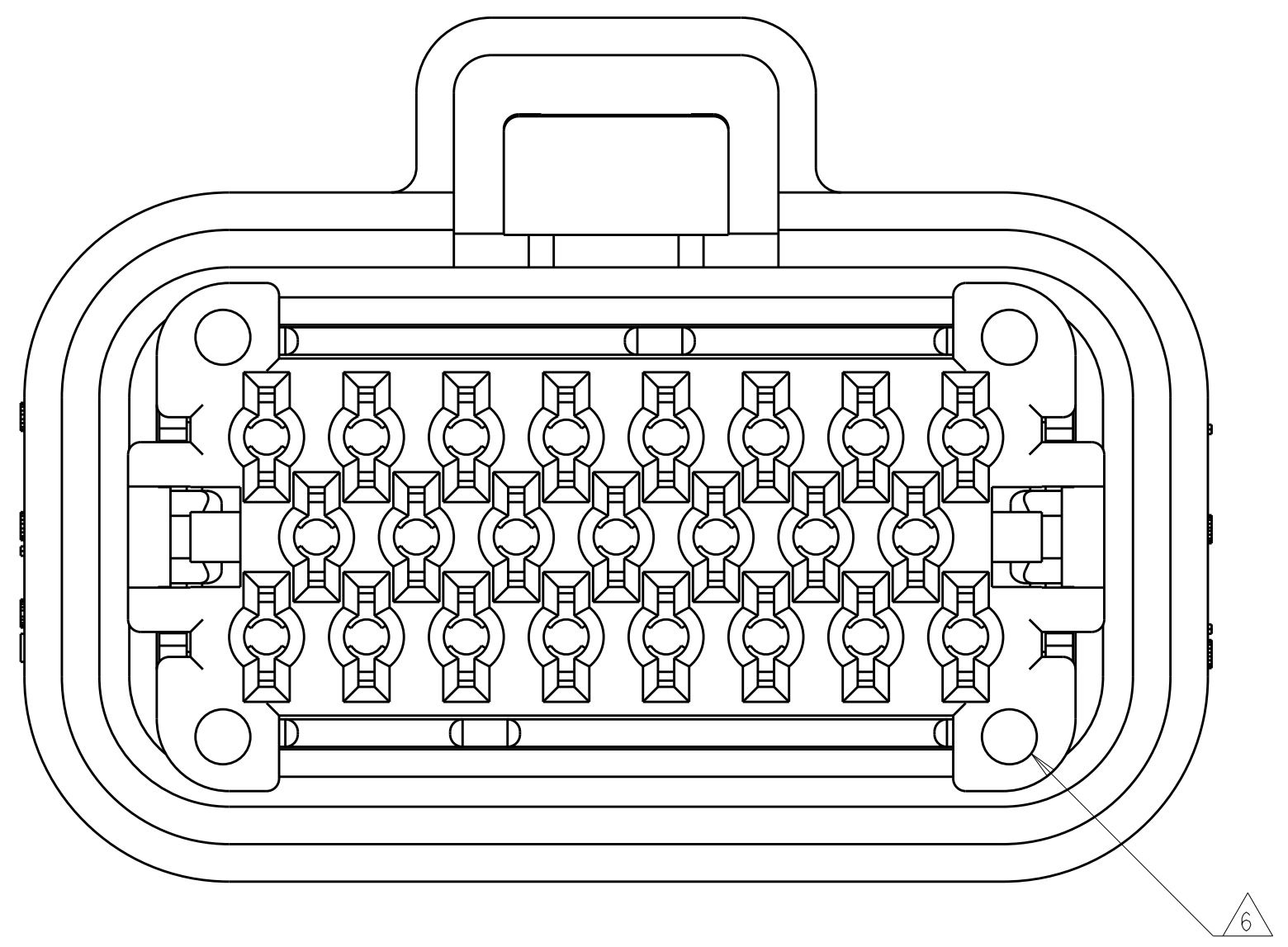

BOTTOM VIEW WITH LOCKING WEDGE

MATING HEADER	RIGHT-ANGLE	WIRE SEAL COLOR	MATING SEAL COLOR	HOUSING COLOR	NO. OF POSITIONS	PART NUMBER
776230, 776231	776180, 776163	RED	RED	ORANGE	35-POSITION	776164-6
				BLUE		776164-5
				GREY		776164-4
				NATURAL		776164-2
776200, 776228	770669, 776087	GREEN	RED	BLACK	23-POSITION	776164-1
				BLUE		770680-5
				GREY		770680-4
				BLACK		770680-3
776261, 776262	776266, 776267	GREEN	GREEN	NATURAL	14-POSITION	770680-2
				BLACK		770680-1
				BLUE		776273-5
				GREY		776273-4
776275, 776276	776279, 776280	YELLOW	YELLOW	NATURAL	8-POSITION	776273-2
				BLACK		776273-1
				NATURAL		776286-2
				BLACK		776286-1

THIS DRAWING IS A CONTROLLED DOCUMENT.

DIMENSIONS: mm

TOLERANCES UNLESS OTHERWISE SPECIFIED:

0 PLC	±
1 PLC	±0.2
2 PLC	±
3 PLC	±
4 PLC	±
ANGLES	±

MATERIAL: SEE NOTE 1

FINISH: -

DATE: 11JUN2015

CHK: A. MARTIN

DATE: 29JUN2015

CHK: D. STRAUSSER

DATE: 29JUN2015

APVD: G. BROWN

DATE: 29JUN2015

PRODUCT SPEC: 108-1329

APPLICATION SPEC: -

SIZE: 114-16016

WEIGHT: -

CUSTOMER DRAWING

SCALE: 4:1

SHEET 1 OF 2

REV E

TE Connectivity

PLUG ASSEMBLY, AMPSEAL FAMILY DRAWING

RESTRICTED TO: A100779C=2293782

REVISIONS				
P.	LTN	DESCRIPTION	DATE	APVD
-	-	SEE SHEET 1	-	-

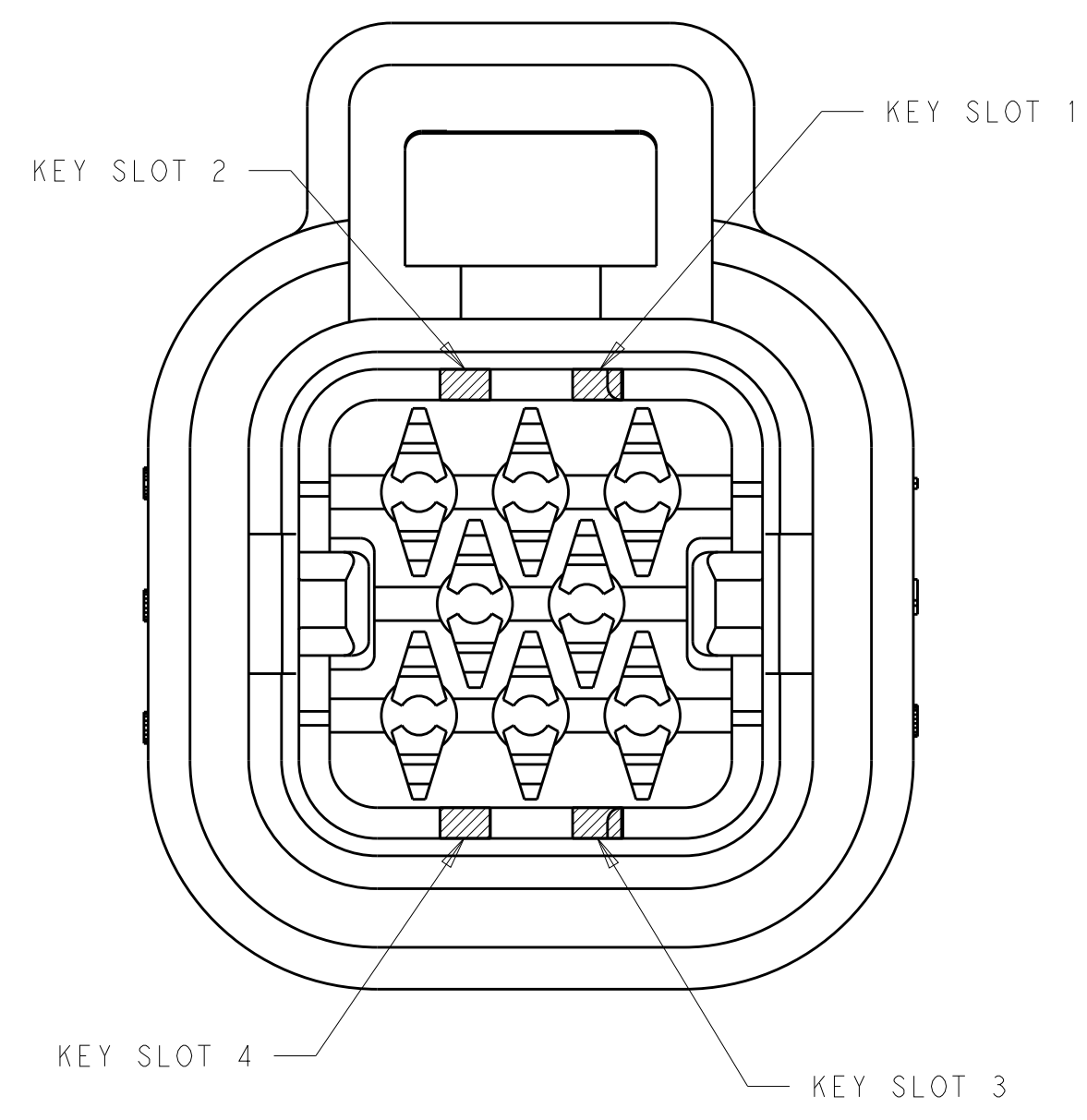

KEY SLOT LOCATION (SEE VIEW ABOVE)	COLOR	PART NUMBER
1 & 3	NATURAL	776286-2
2 & 4	BLACK	776286-1

8-POSITION CONNECTOR  
KEY SLOT LOCATIONS  
SCALE 4:1

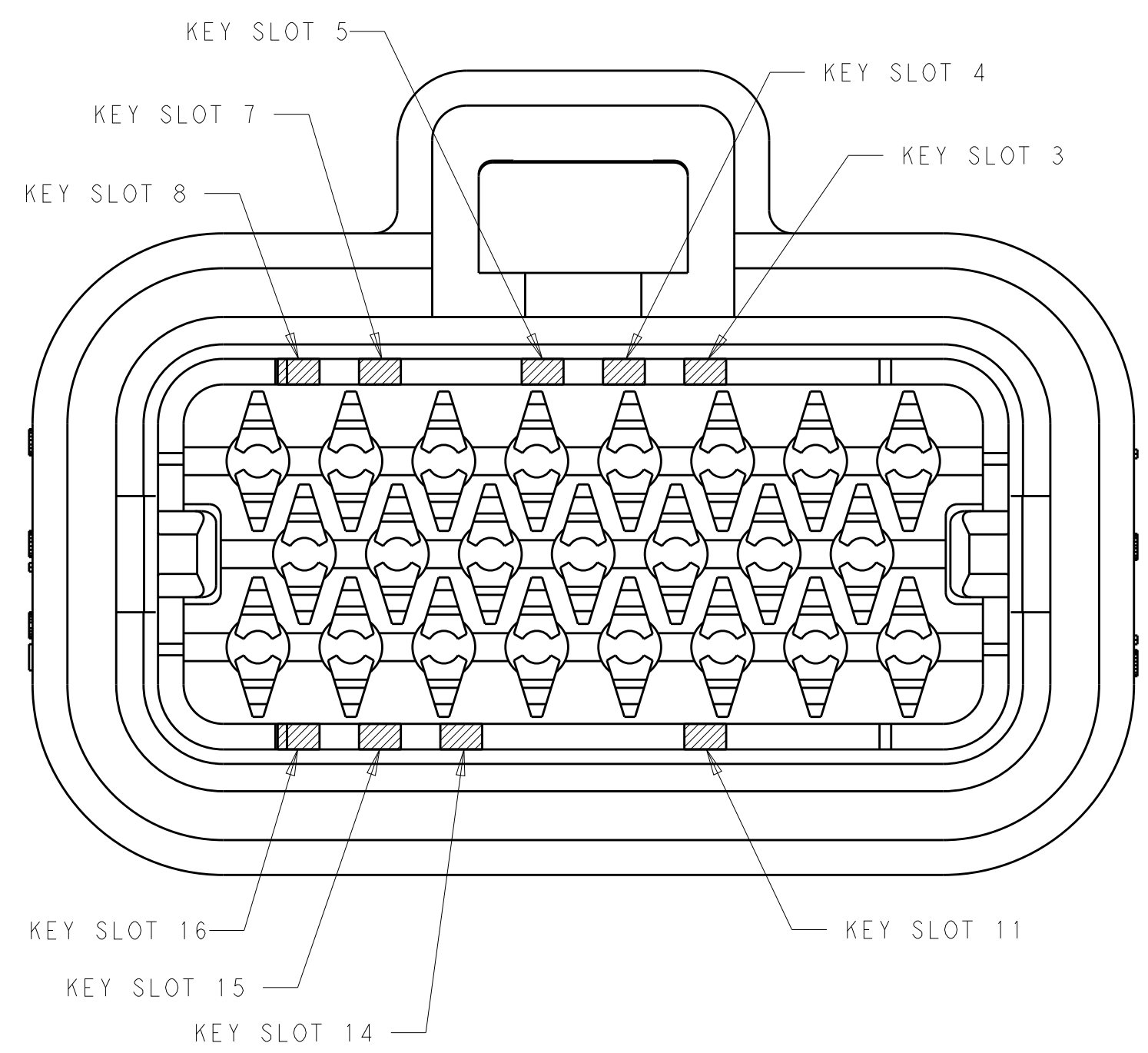

KEY SLOT LOCATION (SEE VIEW ABOVE)	COLOR	PART NUMBER
3, 8 & 16	BLUE	770680-5
7 & 15	GREY	770680-4
4 & 14	BLACK	770680-3
5 & 11	NATURAL	770680-2
4 & 14	BLACK	770680-1

23-POSITION CONNECTOR  
KEY SLOT LOCATIONS  
SCALE 4:1

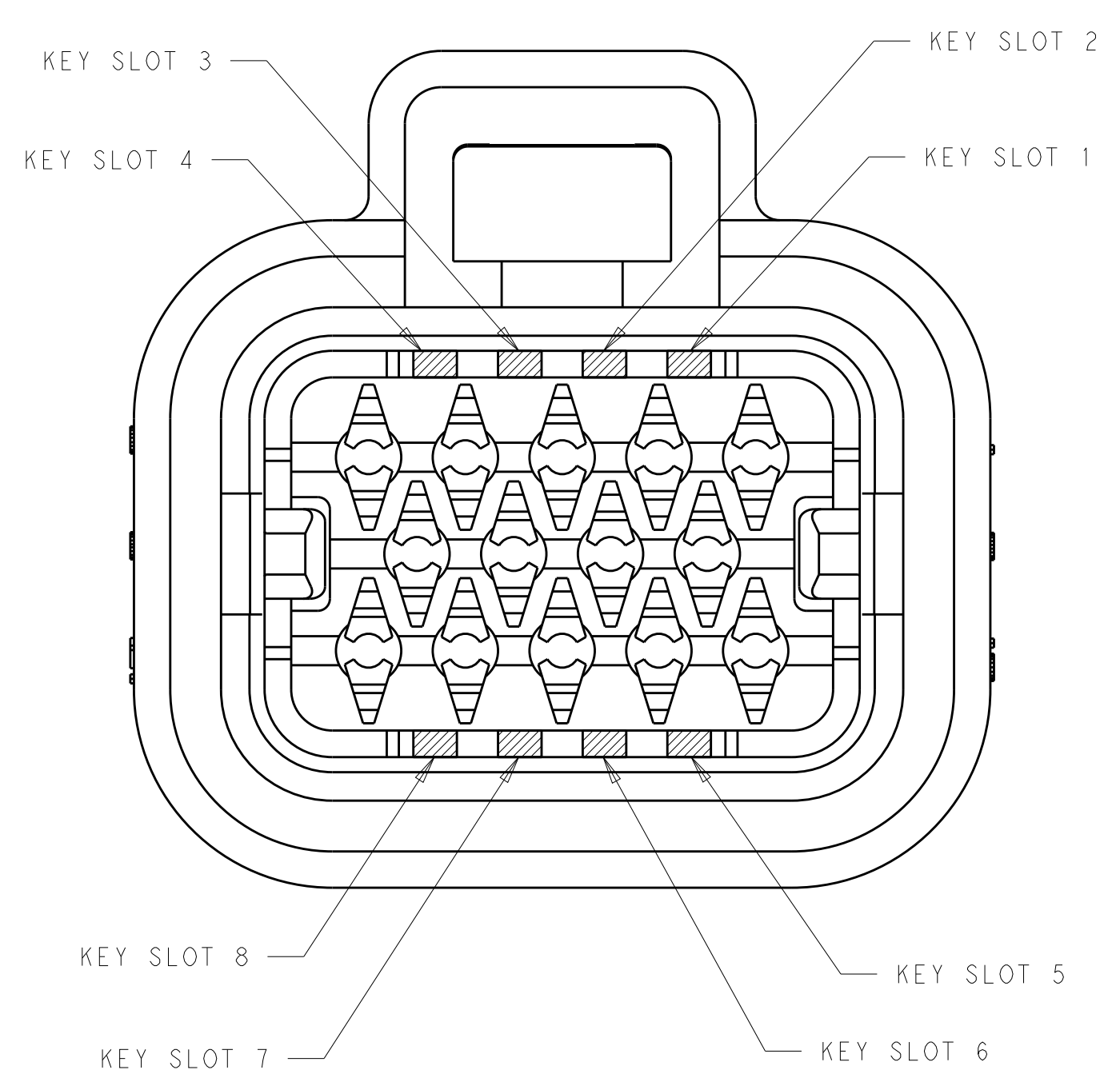

KEY SLOT LOCATION (SEE VIEW ABOVE)	COLOR	PART NUMBER
3 & 5	BLUE	776273-5
2 & 8	GREY	776273-4
1 & 6	NATURAL	776273-2
3 & 7	BLACK	776273-1

14-POSITION CONNECTOR  
KEY SLOT LOCATIONS  
SCALE 4:1

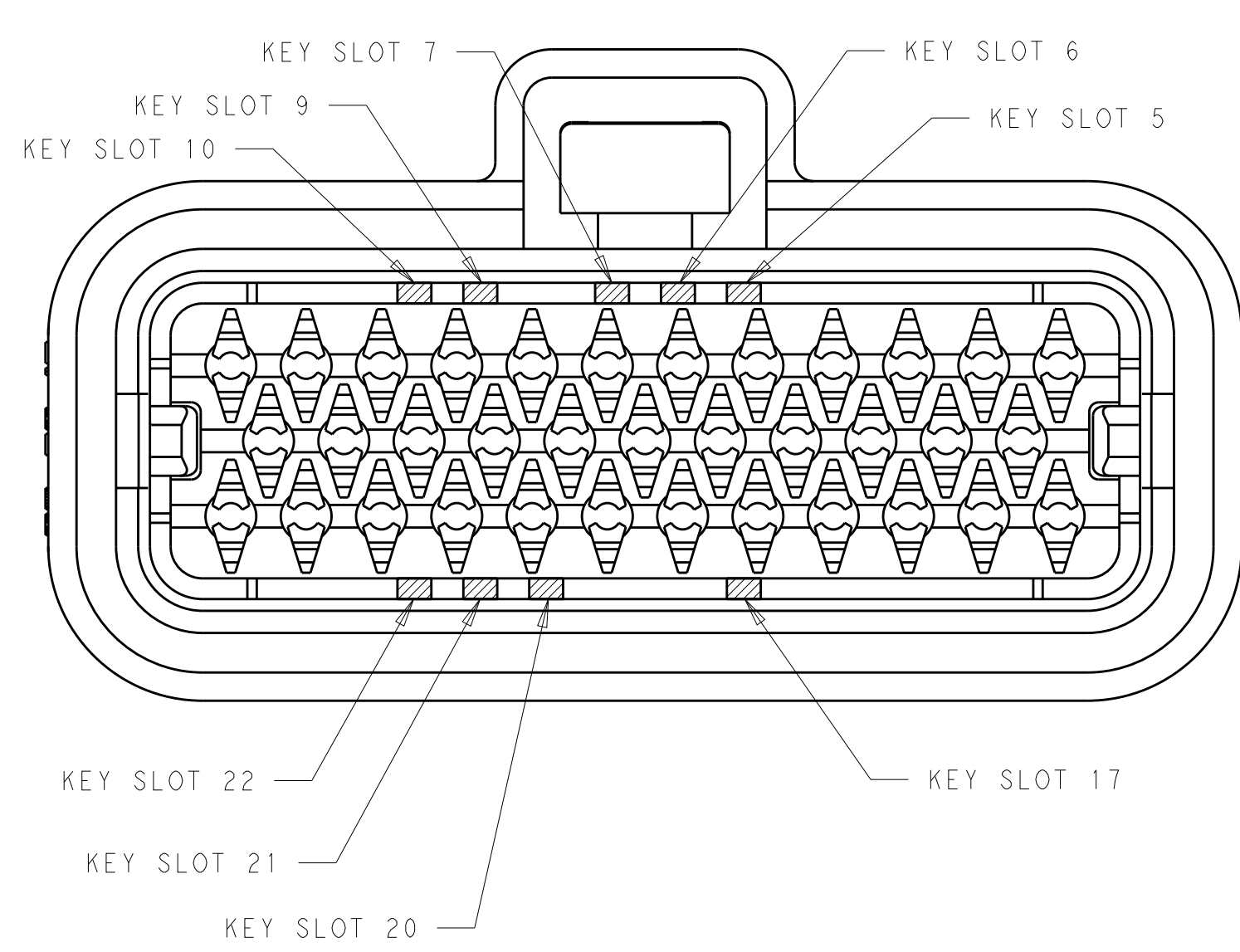

KEY SLOT LOCATION (SEE VIEW ABOVE)	COLOR	PART NUMBER
7 & 22	ORANGE	776164-6
5, 10, 22	BLUE	776164-5
9 & 21	GREY	776164-4
7 & 17	NATURAL	776164-2
6 & 20	BLACK	776164-1

35-POSITION CONNECTOR  
KEY SLOT LOCATIONS  
SCALE 3:1

THIS DRAWING IS A CONTROLLED DOCUMENT.		DWN: A. MARTIN 11JUN2015 CHK: D. STRAUSSER 29JUN2015 APVD: G. BROWN 29JUN2015	TE Connectivity
DIMENSIONS: mm	TOLERANCES UNLESS OTHERWISE SPECIFIED: 0 PLC ± 1 PLC ±0.2 2 PLC ± 3 PLC ± 4 PLC ± ANGLES ±	NAME: PLUG ASSEMBLY, AMPSEAL FAMILY DRAWING PRODUCT SPEC: 108-1329 APPLICATION SPEC: 114-16016 WEIGHT: - CUSTOMER DRAWING	
MATERIAL: -	FINISH: -	SIZE: A1 CAGE CODE: 00779 DRAWING NO: C=2293782	RESTRICTED TO: - SCALE: 1:1 SHEET 2 OF 2 REV E

## X-ON Electronics

Largest Supplier of Electrical and Electronic Components

*Click to view similar products for [Automotive Connectors](#) category:*

*Click to view products by [TE Connectivity](#) manufacturer:*

Other Similar products are found below :

[003-018-000](#) [60403001](#) [60993906-B](#) [M902-2131](#) [M902-2161](#) [M902-2344](#) [72.330.1035.1](#) [73.353.4028.0](#) [F119300-B](#) [F166900](#) [F258300-B](#)  
[F358300-B](#) [F407400](#) [F444110](#) [F487000](#) [F509500B-B](#) [827153-1](#) [8N1515-32-24P](#) [9-1326729-8](#) [925474-1](#) [928905-1](#) [964562-4](#) [968782-1](#)  
[GT17SA-8DS-HU](#) [98891-1012](#) [98947-1016](#) [12004147](#) [12004475-L](#) [12010290](#) [12010309-B](#) [12015454](#) [12020219-B](#) [12041318-B](#) [12052225-](#)  
[L](#) [12052466](#) [12064869](#) [12004327-B](#) [12015308](#) [12015384](#) [12015909](#) [1-21030-1](#) [12041254](#) [12041318](#) [12047946-B](#) [12047957](#) [12047957-L](#)  
[12059473](#) [12066261](#) [12110546](#) [12110546-B](#)