

THIS DRAWING IS UNPUBLISHED. RELEASED FOR PUBLICATION 20
 © COPYRIGHT 20 BY - ALL RIGHTS RESERVED.

REVISIONS					
P	LTR	DESCRIPTION	DATE	DWN	APVD
G1		REVISED PER ECR-16-011494	22JUN2017	NK	CX
G2		ECO-19-006502	30APR2019	AP	WS
G3		REVISED PER ECO-20-009852	14JUL2020	WLS	DZ
G4		REVISED PER ECN-21-100661	17MAR2021	WLS	VS

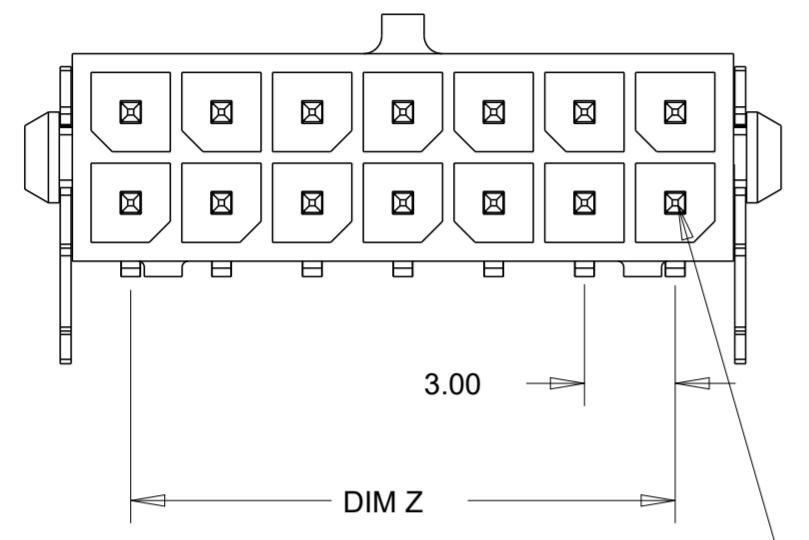

CIRCUIT NUMBER 1

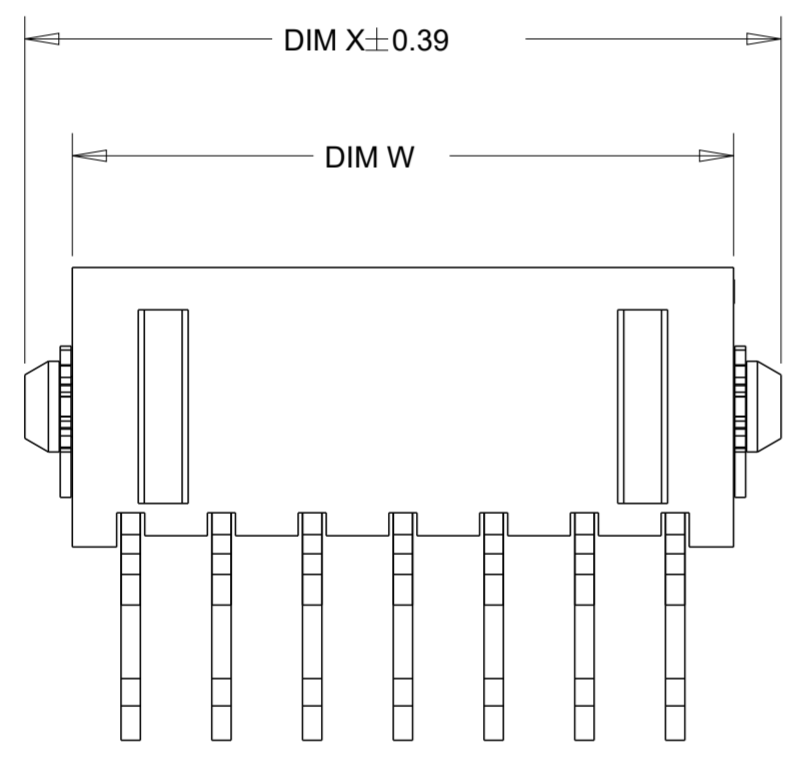
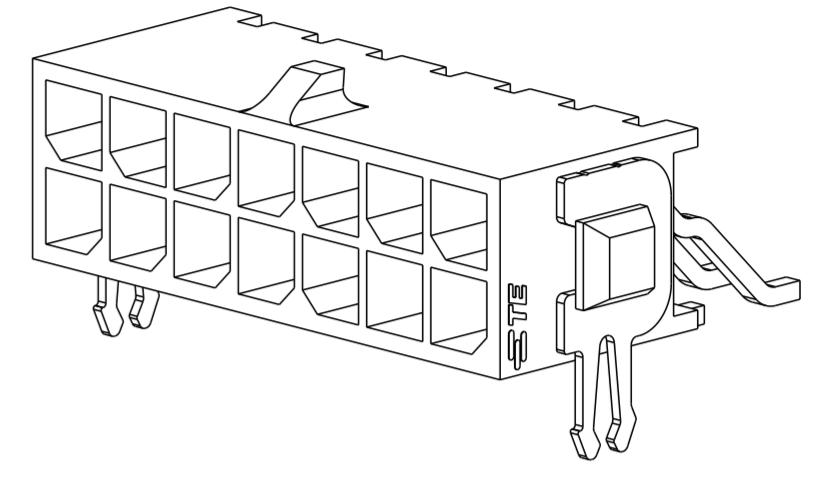
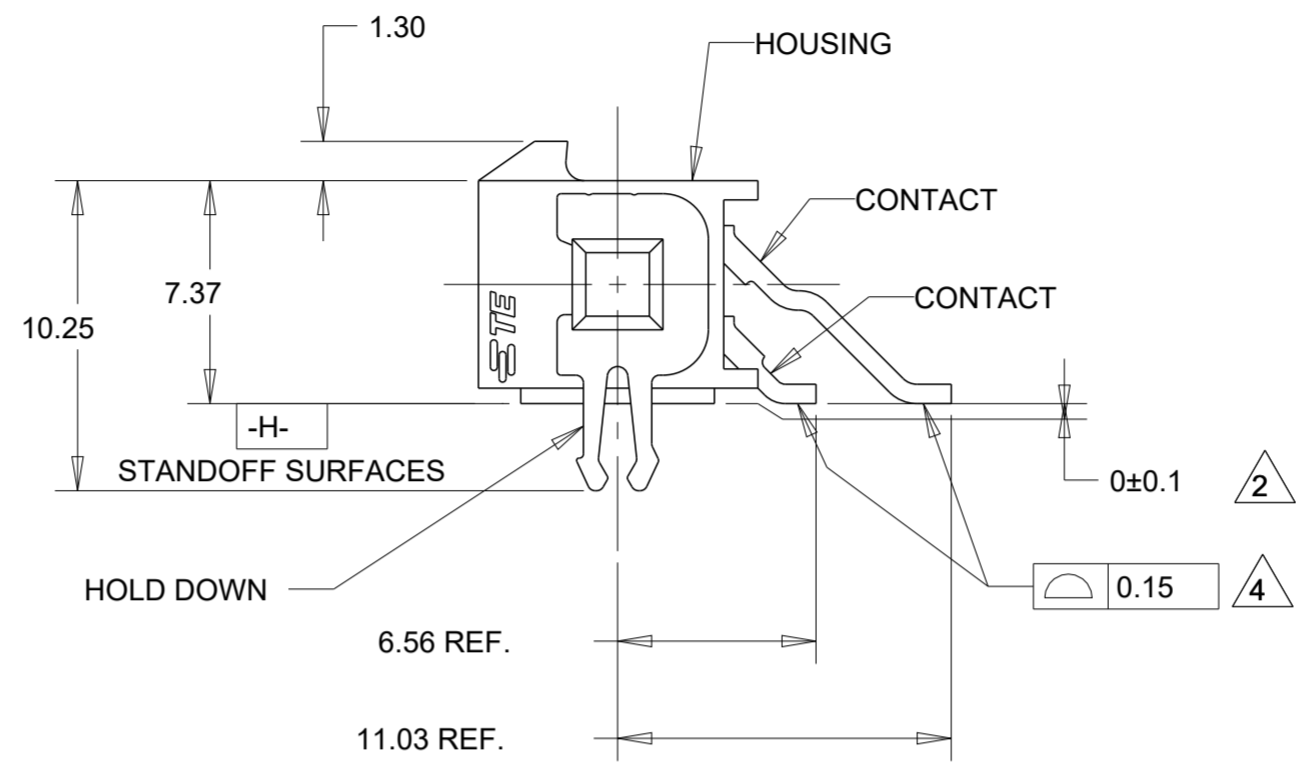

- 1 MATERIAL;
HOUSING - UL 94V-0 RATED HIGH TEMP NYLON, COLOR BLACK.
CONTACTS - BRASS.
HOLD DOWNS - PHOSPHOR BRONZE.
- 2 DIMENSION APPLIES TO SOLDER TAIL SURFACES AND STANDOFF SURFACES.
- 3 RECOMMENDED PC BOARD THICKNESS OF 1.57.
- 4 ALL SOLDER TAILS.
- 5 FINISH;
CONTACTS - 2.54µm MINIMUM MATTE TIN OVER 1.27µm MINIMUM NICKEL.
HOLD DOWNS - 2.54µm MINIMUM MATTE TIN OVER 1.27µm MINIMUM NICKEL.
- 6 COUNTERPART RECOMMENDED IS PN 794617 (DASH ACCORDING TO NUMBER OF POSITION).
- 7 FOR REELING DIRECTION AND PACKAGING TYPE, SEE SPECIFICATION 114-13000.

36.86	37.30	33.00	40.00	24	5-794624-4
33.86	34.30	30.00	37.00	22	5-794624-2
30.86	31.30	27.00	34.00	20	5-794624-0
27.86	28.30	24.00	31.00	18	4-794624-8
24.86	25.30	21.00	28.00	16	4-794624-6
21.86	22.30	18.00	25.00	14	4-794624-4
18.86	19.30	15.00	22.00	12	4-794624-2
15.86	16.30	12.00	19.00	10	4-794624-0
12.86	13.30	9.00	16.00	8	3-794624-8
9.86	10.30	6.00	13.00	6	3-794624-6
6.86	7.30	3.00	10.00	4	3-794624-4
3.86	4.30	-	7.00	2	3-794624-2
DIM W	DIM Y	DIM Z	DIM X	NO. OF POSN.	ASSEMBLY

THIS DRAWING IS A CONTROLLED DOCUMENT.		DWN S. HOOVER 23-MAR-2005	TE Connectivity		
DIMENSIONS: mm		CHK C. JONES 23-MAR-2005			
TOLERANCES UNLESS OTHERWISE SPECIFIED:		APVD C. JONES 23-MAR-2005	NAME SURFACE MOUNT, RIGHT ANGLE, MECH. HOLD DOWN, ASSEMBLY, TIN HEADER, DUAL ROW, MICRO MATE-N-LOK (TM)		
0 PLC ± 1 PLC ± 2 PLC ±0.13 3 PLC ± 4 PLC ± ANGLES ±°		PRODUCT SPEC 108-1836	SIZE A2	CAGE CODE 00779	DRAWING NO. G-794624
MATERIAL 1		FINISH 5	APPLICATION SPEC 114-13000	RESTRICTED TO -	SCALE 4:1
CUSTOMER DRAWING			SHEET 1 OF 2	REV G4	

REVISIONS					
P	LTR	DESCRIPTION	DATE	DWN	APVD
-	-	SEE SHEET 1	-	-	-

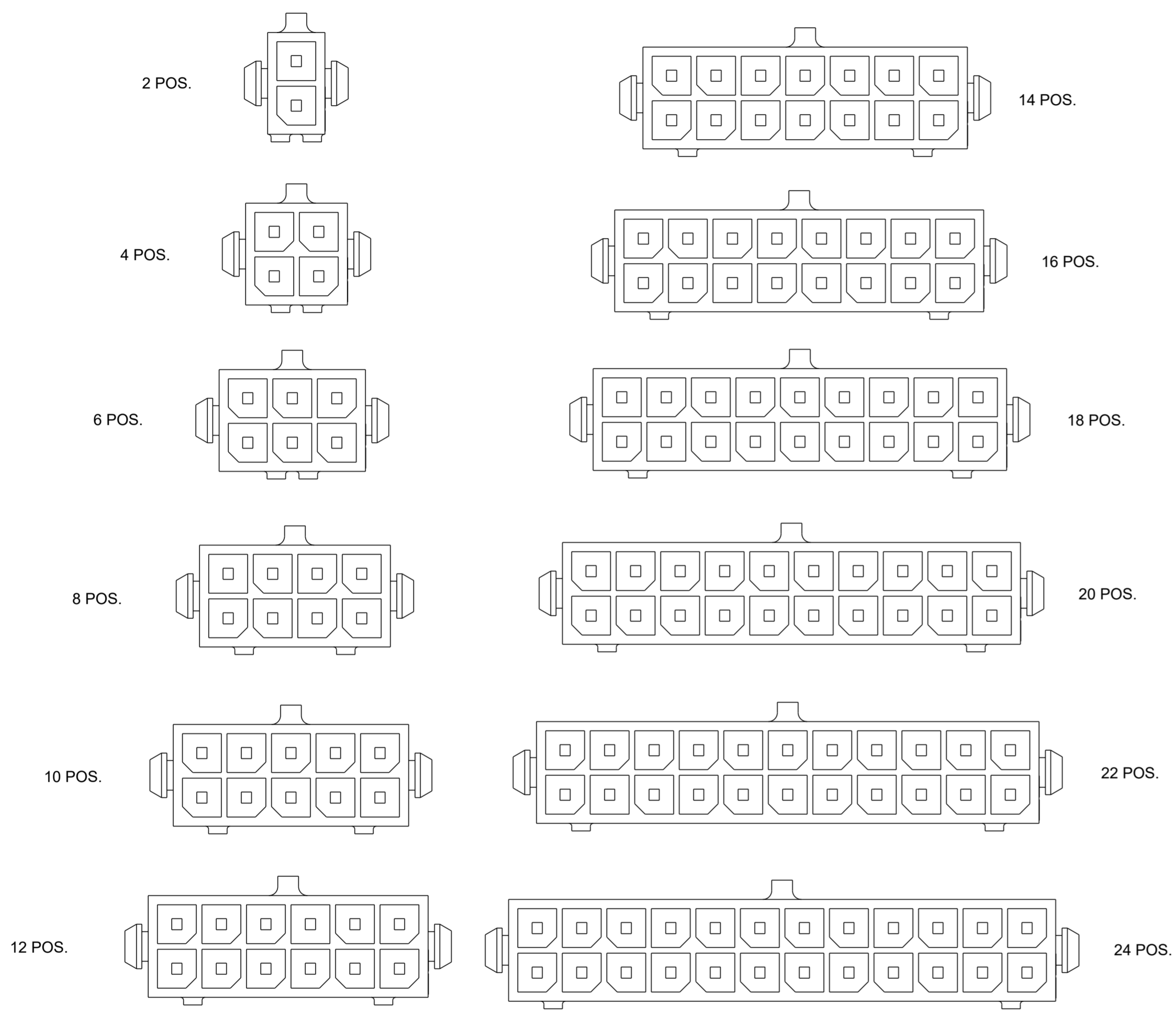

KEYING BY POSITION SIZE

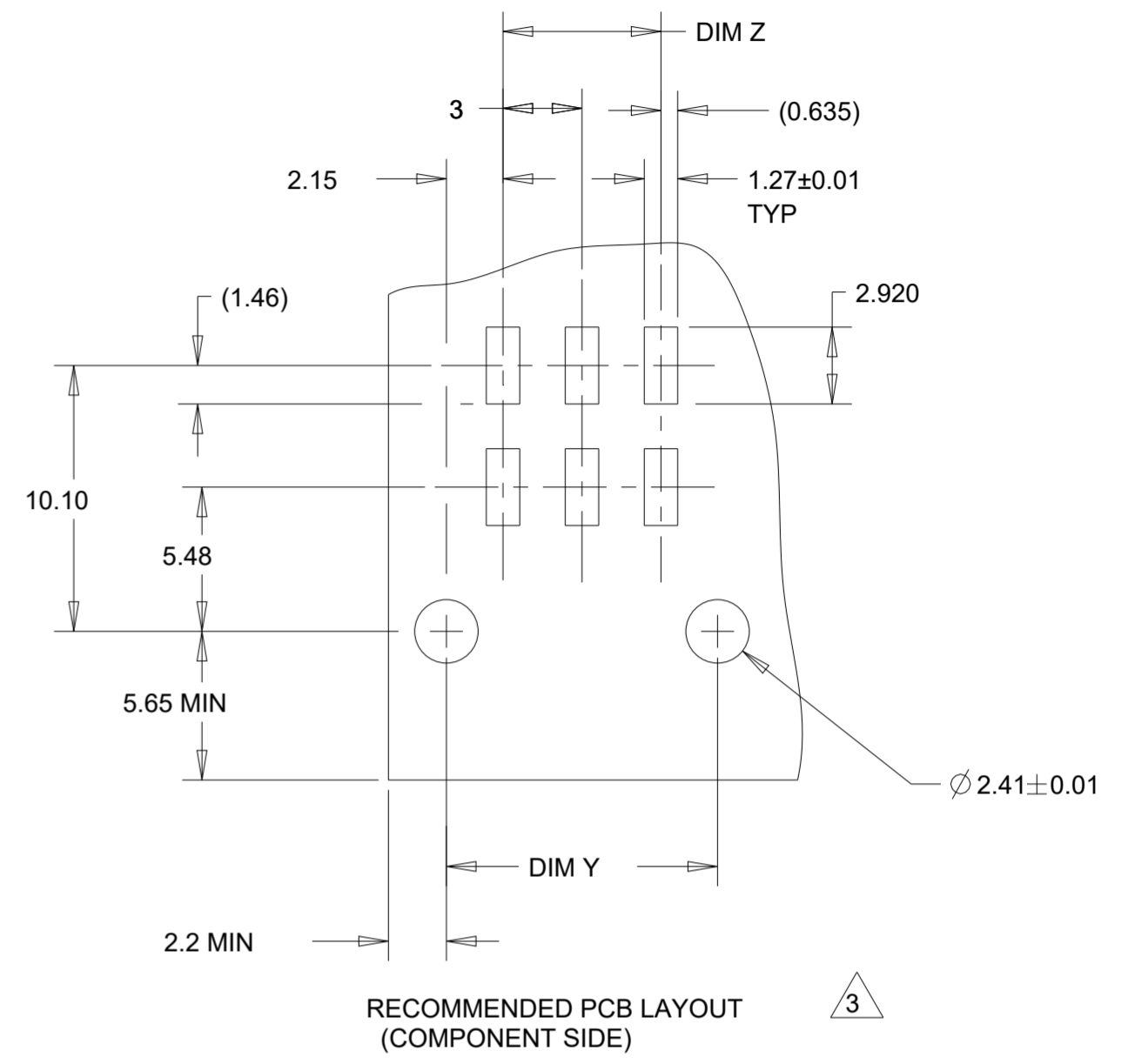

THIS DRAWING IS A CONTROLLED DOCUMENT.		DWN S. HOOVER 23-MAR-2005	 TE Connectivity		
DIMENSIONS: mm		CHK C. JONES 23-MAR-2005			
TOLERANCES UNLESS OTHERWISE SPECIFIED:		APVD C. JONES 23-MAR-2005	NAME SURFACE MOUNT, RIGHT ANGLE, MECH. HOLD DOWN, ASSEMBLY, TIN HEADER, DUAL ROW, MICRO MATE-N-LOK (TM)		
0 PLC ± 1 PLC ± 2 PLC ±0.13 3 PLC ± 4 PLC ± ANGLES ±°		PRODUCT SPEC 108-1836	SIZE A2	CAGE CODE 00779	DRAWING NO G-794624
MATERIAL -		FINISH -	RESTRICTED TO -	SCALE 4:1	SHEET 2 OF 2
-		WEIGHT -	CUSTOMER DRAWING	REV G4	

X-ON Electronics

Largest Supplier of Electrical and Electronic Components

Click to view similar products for [Pin & Socket Connectors](#) category:

Click to view products by [TE Connectivity](#) manufacturer:

Other Similar products are found below :

[6450822-1](#) [770392-1](#) [794042-1](#) [796885-1](#) [8-794535-1](#) [PLR3455ACS-222](#) [R929991004](#) [R929993003](#) [1403611-1](#) [1-480349-5](#) [152302-5](#)
[153211-2](#) [1586092-1](#) [1586129-1](#) [1586681-4](#) [1586700-1](#) [1586368-1](#) [1586380-1](#) [1586616-1](#) [1586680-5](#) [16-06-0038](#) [164164-5](#) [1-6609930-1](#)
[172296-1](#) [19-09-2035](#) [200503-1](#) [200788-2](#) [2029090-4](#) [2029095-4](#) [925061-7](#) [293734-4](#) [293737-2](#) [1-765362-4](#) [1-794606-3](#) [1871534-1](#)
[200833-4](#) [2008625-2](#) [2029027-2](#) [2029096-4](#) [R929991000](#) [R929991002](#) [R929993000](#) [319-10-101-00-005000](#) [319-10-102-00-001000](#)
[319-10-104-00-001000](#) [319-10-105-00-001000](#) [319-10-108-00-001000](#) [319-10-112-00-006000](#) [39-01-8019](#) [319-10-101-00-001000](#)