

THIS DRAWING IS UNPUBLISHED. RELEASED FOR PUBLICATION
 © COPYRIGHT BY TYCO ELECTRONICS CORPORATION. ALL RIGHTS RESERVED.

LOC	DIST	REVISIONS					
FT	0	P	LTR	DESCRIPTION	DATE	DWN	APVD
			F	REVISED PER ECO-09-004812	04MAY10	HMR	CR

MATERIALS:
 HOUSING: THERMOPLASTIC, UL94V-0, BLACK.
 TERMINAL: BRIGHT TIN OVER COPPER ALLOY.
 SCREWS: 8-32, ZINC PLATED STEEL.







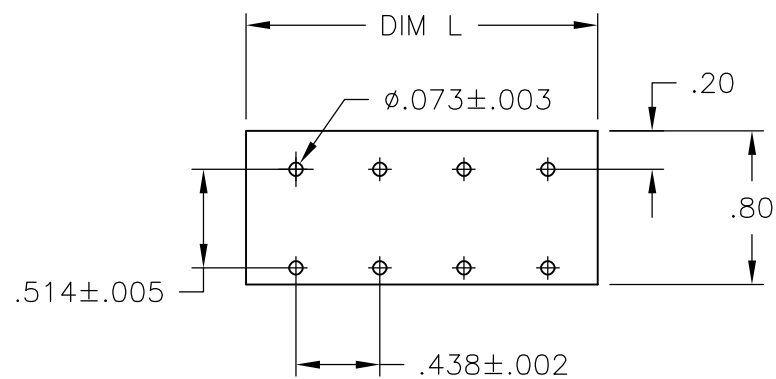
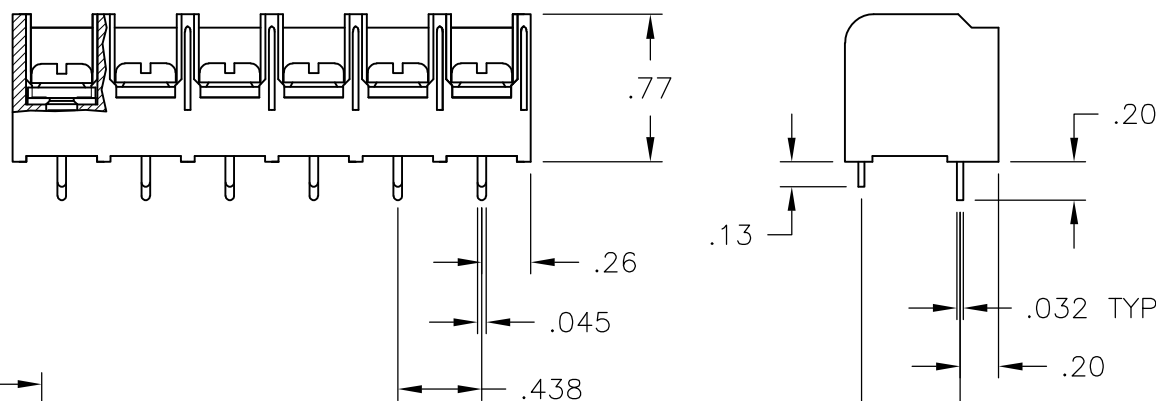
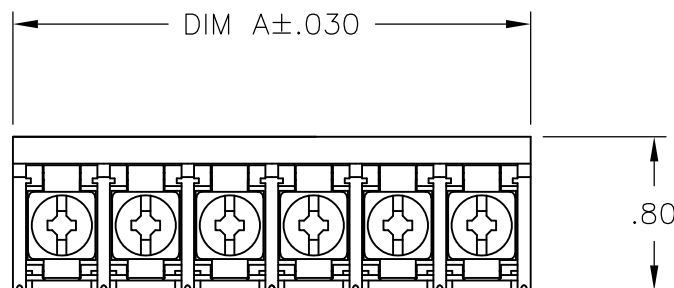







ELECTRICAL:
 CURRENT RATING: 30A
 VOLTAGE RATING: 600V
 WIRE RANGE: 10-18 AWG (UL)
 10-22 AWG (CSA)

MECHANICAL:
 RECOMMENDED TORQUE: 20 IN-LB.
 OPERATING TEMP.: -40°C TO +120°C MAX.

-  PRELIMINARY PART NUMBER.
-  TERMINAL TAPPED TO M4 WITH NO SCREWS



RECOMMENDED PCB LAYOUT

OBSOLETE	-9.698	22	8DBL-22-006	2-796709-2
OBSOLETE	-9.260	21	8DBL-21-006	2-796709-1
	8.823	20	8DBL-20-006	2-796709-0
	8.385	19	8DBL-19-006	1-796709-9
	7.948	18	8DBL-18-006	1-796709-8
	7.510	17	8DBL-17-006	1-796709-7
	7.073	16	8DBL-16-006	1-796709-6
	6.635	15	8DBL-15-006	1-796709-5
	6.198	14	8DBL-14-006	1-796709-4
	5.760	13	8DBL-13-006	1-796709-3
	5.323	12	8DBL-12-006	1-796709-2
	4.885	11	8DBL-11-006	1-796709-1
	4.448	10	8DBL-10-006	1-796709-0
	4.010	9	8DBL-09-006	796709-9
	3.573	8	8DBL-08-006	796709-8
	3.135	7	8DBL-07-002	796709-2
	3.135	7	8DBL-07-006	4-1546159-7
	2.698	6	8DBL-06-006	1-1437657-7
	2.260	5	8DBL-05-006	4-1546159-6
	1.823	4	8DBL-04-006	1-1437657-3
 OBSOLETE	-1.385	3	8DBL-03-649	1986428-1
	1.385	3	8DBL-03-006	1-1437657-1
	.948	2	8DBL-02-656	2-796709-3
	.948	2	8DBL-02-006	1437657-8
DIM A	NO OF POS	CATALOG NUMBER	TE PART NO.	

THIS DRAWING IS A CONTROLLED DOCUMENT.		DWN	S SCHLEGEL	6/20/03	 Tyco Electronics Corporation Harrisburg, PA 17105-3608				
DIMENSIONS: INCHES		CHK	S YODER	6/20/03				NAME	
TOLERANCES UNLESS OTHERWISE SPECIFIED:		APVD	S YODER	6/20/03	8DBL-XX-006 ASSEMBLY				
0 PLC ± - 1 PLC ± - 2 PLC ± .02 3 PLC ± .015 4 PLC ± - ANGLES ± 1°		PRODUCT SPEC		APPLICATION SPEC		RESTRICTED TO			
MATERIAL		FINISH		WEIGHT		SIZE	CAGE CODE	DRAWING NO	RESTRICTED TO
-		-		-		A3	00779	G-1-1437657-1	-
CUSTOMER DRAWING				SCALE	1:1	SHEET	1 OF 1	REV	F

X-ON Electronics

Largest Supplier of Electrical and Electronic Components

Click to view similar products for [Barrier Terminal Blocks](#) category:

Click to view products by [TE Connectivity](#) manufacturer:

Other Similar products are found below :

[6C1N03](#) [6PCR-02-008](#) [6PCR-05-008](#) [6PCR-08-008](#) [6PCR-21-006](#) [6PCV-06-008](#) [6PCV-10-009](#) [6PCV-15-008](#) [6STR-06-006](#) [6STR-08-006](#)
[6STR-12-008](#) [6STR-14-008](#) [6STR-16-008](#) [6STR-17-008](#) [6STR-21-008](#) [6STR-25-008](#) [6STR-27-008](#) [6STV-03-006](#) [6STV-03-008](#) [6STV-04-006](#) [6STV-10-006](#) [6WWR-03](#) [6WWV-12-008](#) [6WWV-16-008](#) [7-1546701-0](#) [72212603](#) [72503-C](#) [72504-C-50](#) [73203](#) [76007](#) [7604-501LF](#)
[77010-50](#) [796985-3](#) [796988-4](#) [7C1N08](#) [8-1437402-5](#) [8-1437402-7](#) [8-1546158-0](#) [870505](#) [870903](#) [8PCR-06-006](#) [8PCV-02-008](#) [8PCV-05-008](#)
[8PCV-09-006](#) [8PCV-15-006](#) [8PCV-17-006](#) [8QCR-03-008](#) [8STV-04-006](#) [9-1437402-3](#) [A103104](#)