

Quick Reference Guide

# INDUSTRIAL RELAYS

RELAYS, CONTACTORS & CIRCUIT BREAKERS

TE Connectivity (TE) has extensive capabilities in the design and manufacture of relays and a broad portfolio of switching solutions for demanding, high performance applications. These relay products are remotely actuated to control electrical power flow by either interrupting or completing an electrical circuit.

Complying with standardized PCB footprints, TE offers a wide range of inrush current capabilities and addresses the complete spectrum of requirements for production lines, robotics, elevators, control panels, CNC machines, motion control systems, lighting, building systems, solar, HVAC, and an array of safety-critical applications. Through agency approved test labs, we ensure that our relays are tested to meet the expectations of the industry. Whether you are designing for harsh or indoor applications, TE delivers high quality relays from state-of-the-art production lines.



# CONTENTS

## RELAYS, CONTACTORS & CIRCUIT BREAKERS

Power PCB Relays up to 16A.....	4
Power PCB Relays up to 50A+.....	11
Force Guided Relays.....	14
Panel Plug-In Relays .....	16
Signal Relays.....	22
High Frequency Relays .....	27
Solid State Relays.....	28
Circuit Breakers .....	33
Transformers.....	36

### MOTION CONTROL



# WHAT'S INSIDE

# Power PCB Relays up to 16A

## Relays, Contactors & Circuit Breakers

### Key Features

#### SCHRACK PE

Low height 10.0mm  
Sensitive 200mW coil  
Mono-or bistable coil  
WG type available (IEC 60335-1)

#### SCHRACK RE/REL

Miniature PCB relays  
PCB area 200mm<sup>2</sup>  
Wash tight

#### PCJ

Slim outline  
Sensitive coil 200mW  
WG type available (IEC 60335-1)  
Ambient temperature up to 105°C

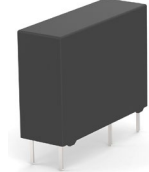
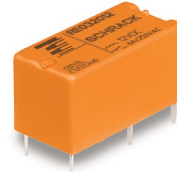

### Footprint

2) see footnote below

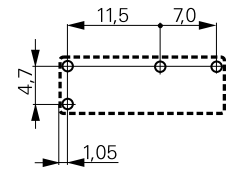
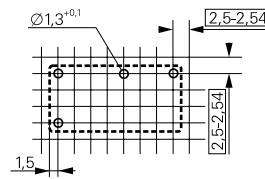
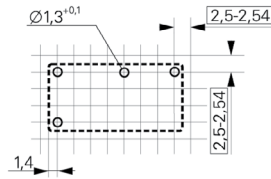

### Applications

Industrial electronics  
White goods  
Measurement and control

PLC; Timers; I/O cards  
Temperature control  
White goods

Home applications  
HVAC

### Contact Data

Contact arrangement	1 form C (CO)	1 form A (NO)	1 form A (NO)
Rated voltage	250VAC	250VAC	250VAC
Rated current	5A (CO) 6A (NO)	6/5A	3A/5A (WG type)
Switching power / Max. break	1250VA	1500/1250VA	750VA/1250VA (WG type)
Contact material	AgNi 90/10, AgSnO <sub>2</sub>	AgNi 0.15, AgNi 90/10	AgNi
Min. recommended contact load	1) see footnote below	1) see footnote below	100mA at 5VDC

### Coil Data

Magnetic system	DC, bistable	DC	DC
Rated coil voltage	3 to 48VDC	5 to 48VDC	5 to 24VDC
Rated coil power	200mW	200/360mW	200mW

### Dielectric Strength

Initial dielectric strength	between open contacts	1000Vrms	1000Vrms	750Vrms
	between contact and coil	4000Vrms	4000/3000Vrms	4000Vrms
	between adjacent contacts			
Clearance/creepage	between contact and coil	3.2/4mm	4/4mm	8/>8mm

### Other Data

Ambient temperature (max.)	+ 85°C	+70°C (RE)/ + 85°C (REL)	+ 85/ +105°C (WG type)
Category of environmental protection IEC61810	RTII, RTIII	RTIII(RE), RTII(REL)	RTII, RTIII
Terminal type	THT	THT	THT
Mounting	PCB	PCB	PCB
Dimensions	20x10x10mm	20x10x10.6mm/20.7x10.7x12mm	20.4x7x15mm

### Accessories

Link to datasheet	<a href="#">SCHRACK PE</a>	<a href="#">SCHRACK RE</a> <a href="#">SCHRACK REL</a>	<a href="#">PCJ</a>
-------------------	----------------------------	---	---------------------

1) Recommended minimum load indication for contact material: AU and gold plated: 1mA at 6VDC; AgNi0.15 and AgNi90/10: 10mA at 12VDC; AgCdO and AgSnO<sub>2</sub>: 100mA at 12VDC. Please contact technical support for detailed technical data. 2) Footprint images are representative. For a complete selection, refer to the TE data sheet via the link above.

# Power PCB Relays up to 16A

## Relays, Contactors & Circuit Breakers

### Key Features

#### PCH

Compact size  
WG type available (IEC 60335-1)  
TV-3 ratings for NO contact

#### OJ/OJE/T77

Miniature size  
Sensitive coil 200mW  
4kV coil-contacts (OJ/OJT)  
Meet UL TV-5 ratings (OJT)

#### PCN/PCNH

1 pole 3A/5A  
Only 5mm wide  
Allows high function/packaging density  
RoHS compliant  
(Directive 2002/95/EC)

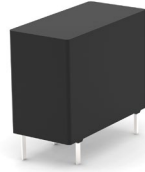

### Footprint

2) see footnote below

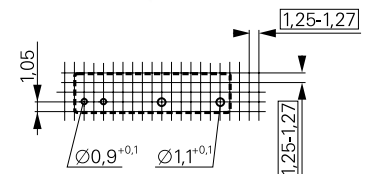
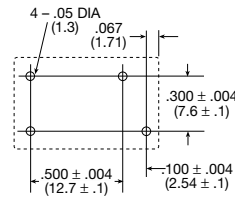
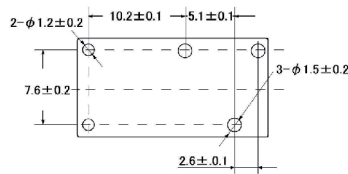

Applications	Appliances HVAC Refrigerators, microwave ovens	Appliances HVAC Industrial control	PLC Temperature control I/O modules
<b>Contact Data</b>			
Contact arrangement	1 form C (CO), 1 form A (NO)	1 form A (NO)	1 form A (NO)
Rated voltage	277VAC/30VDC	250VAC/28VDC	250VAC
Rated current	3/5/10A	3/5/8/10A	3A/5A
Switching power / Max. break	1400VA/150W (NO) 850VA/90W (NC)	720 to 2500VA/ 90 to 240W	750VA /1250VA
Contact material	AgSnO <sub>2</sub>	Ag, AgCdO, AgSnO <sub>2</sub>	AgNi gold plated
Min. recommended contact load	100mA at 5VDC	1) see footnote below	100mA at 5VDC
<b>Coil Data</b>			
Magnetic system	DC, sensitive	DC, sensitive	DC
Rated coil voltage	3 to 48VDC	3 to 48VDC	3 to 24VDC
Rated coil power	200/400mW	200/250/450mW	100mW/120mW
<b>Dielectric Strength</b>			
<b>Initial dielectric strength</b>			
between open contacts	750Vrms	750/1000Vrms	750Vrms
between contact and coil	4000Vrms	3000/4000Vrms	3000Vrms
between adjacent contacts			
<b>Clearance/creepage</b>			
between contact and coil	1.6/3.2mm	1.6/3.2mm and 3.2/6.4mm	3.5mm
<b>Other Data</b>			
Ambient temperature (max.)	+70°C (standard)/+85°C (WG type)	up to 85°C	+85°C
Category of environmental protection IEC61810	RTII, RTIII	RTII, RTIII	RTIII
Terminal type	THT	THT	THT
Mounting	PCB	PCB	PCB
Dimensions (lwh)	20x10x15.2mm	18.2x10.2x14.7mm	20x5x12.5mm
<b>Accessories</b>			
<b>Link to datasheet</b>	<a href="#">PCH</a>	<a href="#">OJ/OJE</a> <a href="#">T77</a>	<a href="#">PCN</a>

1) Recommended minimum load indication for contact material: AU and gold plated: 1mA at 6VDC; AgNi015 and AgNi90/10: 10mA at 12VDC; AgCdO and AgSnO<sub>2</sub>: 100mA at 12VDC. Please contact technical support for detailed technical data. 2) Footprint images are representative. For a complete selection, refer to the TE data sheet via the link above.

**Key Features**

**SCHRACK SNR**

5mm wide slim outline  
Strong coil pins for DIN-rail socket  
Allows high function/  
packaging density

**SCHRACK RYII**

Reflow solderable version  
Low height 12.3mm  
Reinforced insulation  
Pinnings 3.2mm and 5mm

**SCHRACK MSR/T75**

High inrush currents with AgSnO contacts  
4kV/8mm coil-contact  
Reinforced insulation

**Footprint**

2) see footnote below

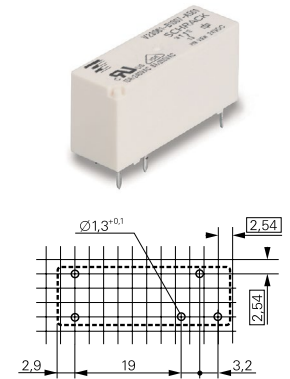
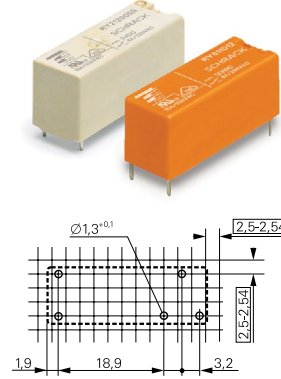
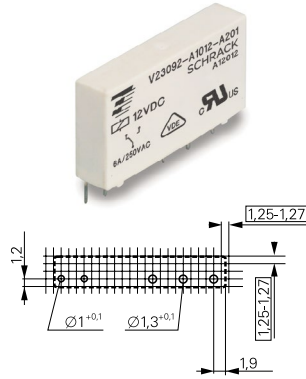

Applications	Interface technology PLC, timers, Heating control	Interface technology HVAC, PLC, Power supplies Domestic appliances	Interface technology HVAC, PLC, Power supplies Domestic appliances
<b>Contact Data</b>			
Contact arrangement	1 form C (CO), 1 form A (NO)	1 form C (CO), 1 form A (NO), 1 form B (NC)	1 form C (CO) 1 form A (NO)
Rated voltage	250VAC	250VAC	250VAC
Rated current	6A	8A	8/10A
Switching power / Max. break	1500VA	2000VA	2000VA
Contact material	AgSnO <sub>2</sub> , AgSnO <sub>2</sub> gold plated	AgNi0.15, AgSnO <sub>2</sub> , AgNi 0.15 gold plated	AgNi90/10, AgSnO <sub>2</sub>
Min. recommended contact load	100mA at 12VDC	1) see footnote below	1) see footnote below
<b>Coil Data</b>			
Magnetic system	DC	DC	DC
Rated coil voltage	5 to 48VDC	5 to 60VDC	3 to 60VDC
Rated coil power	170/217mW	(223 - 257)mW	(212-262)mW
<b>Dielectric Strength</b>			
Initial dielectric strength			
between open contacts	1000Vrms	1000Vrms	1000Vrms
between contact and coil	4000Vrms	5000Vrms	4000Vrms
between adjacent contacts			
Clearance/creepage			
between contact and coil	6/8mm	8/8mm	8/8mm
<b>Other Data</b>			
Ambient temperature (max.)	+85°C	+70°C	+85°C
Category of environmental protection IEC61810	RTIII	RTII, RTIII	RTII, RTIII
Terminal type	THT	THT, THR	THT
Mounting	PCB or on socket	PCB or on socket	PCB
Dimensions (lwh)	28x5x15mm	28.5x10.1x12.3mm	28.6x10x15mm
<b>Accessories</b>	DIN rail sockets	PCB sockets	
<b>Link to datasheet</b>	<a href="#">SCHRACK SNR</a>	<a href="#">SCHRACK RYII</a>	<a href="#">SCHRACK MSR</a>

1) Recommended minimum load indication for contact material: AU and gold plated: 1mA at 6VDC; AgNi0.15 and AgNi90/10: 10mA at 12VDC; AgCdO and AgSnO<sub>2</sub>: 100mA at 12VDC. Please contact technical support for detailed technical data. 2) Footprint images are representative. For a complete selection, refer to the TE data sheet via the link above.

# Power PCB Relays up to 16A

## Relays, Contactors & Circuit Breakers

### Key Features

#### SCHRACK RZ

High performance version available  
Reinforced insulation  
High ambient temperature version (105°C)  
WG type available (IEC 60335-1)  
AgNi and AgSnO contact versions  
THR (reflow) version

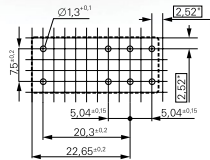
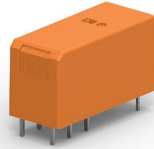

#### SCHRACK RT

DC and AC coil  
Mono-or bistable coil  
Reinforced insulation  
WG type available (IEC 60335-1)  
High ambient temperature version (105°C)  
THR (reflow) version  
Sensitive version  
Bifurcated contacts

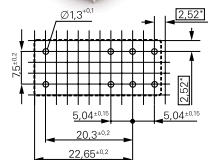

#### SCHRACK RT INRUSH

For inrush peak currents up to 80A  
Mono-or bistable coil  
Reinforced insulation  
WG type available (IEC 60335-1)

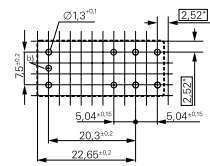

### Footprint

2) see footnote below

### Applications

Household appliances  
HVAC, Home automation  
Machine control, Energy control

HVAC, Home automation,  
Machine control, Energy control  
Switching cabinet, Interface modules

Lighting applications, Movement detectors, Motors control, Domestic appliances

### Contact Data

Contact arrangement	1 form C (CO) 1 form A (NO)	1 form C (CO), 1 form A (NO) 2 form C (CO), 2 form A (NO)	1 form C (CO) 1 form A (NO)
Rated voltage	250VAC	250VAC	250VAC
Rated current	16A	2X8/16A	16A
Switching power / Max. break	4000VA	2X2000/4000VA	4000VA
Contact material	AgNi90/10, AgSnO <sub>2</sub>	AgNi90/10, AgSnO <sub>2</sub>	AgNi90/10, AgSnO <sub>2</sub>
Min. recommended contact load	1) see footnote below	1) see footnote below	1) see footnote below

### Coil Data

Magnetic system	DC	DC, AC, bistable	DC, bistable
Rated coil voltage	5 to 48VDC	5 to 110VDC/24 to 230VAC	5 to 11VDC
Rated coil power	400mW	400mW/0.75VA	400mW

### Dielectric Strength

Initial dielectric strength			
between open contacts	1000Vrms	1000Vrms	1000Vrms
between contact and coil	5000Vrms	5000Vrms	5000Vrms
between adjacent contacts		2500Vrms	
Clearance/creepage			
between contact and coil	>10/10mm	>10/10mm	>10/10mm

### Other Data

Ambient temperature (max.)	+85°C +105°C (HOT type) +70°C (transparent cover type)	+75°C (AC type) +85°C	+85°C
Category of environmental protection IEC61810	RTII, RTIII	RTII, RTIII	RTII
Terminal type	THT	THT, THR (DC and AC type)	THT
Mounting	PCB	PCB or on socket	PCB or socket
Dimensions (lwh)	29x12.7x15.7mm	29x12.7x15.7mm	29x12.7x15.7mm

### Accessories

PCB and DIN rail sockets

### Link to datasheet

[SCHRACK RZ](#)

[SCHRACK RT](#)

[SCHRACK RT INRUSH](#)

1) Recommended minimum load indication for contact material: AU and gold plated: 1mA at 6VDC; AgNi0.15 and AgNi90/10: 10mA at 12VDC; AgCdO and AgSnO<sub>2</sub>: 100mA at 12VDC. Please contact technical support for detailed technical data. 2) Footprint images are representative. For a complete selection, refer to the TE data sheet via the link above.

**Key Features**

**SCHRACK RTX**

Inrush peak currents up to 370A  
Bistable coil  
Reinforced insulation  
16A rated fluorescent load acc. EN60669-1  
8A electronic ballast acc. UL508  
1 1/2 HP motor load acc. UL508

**SCHRACK RT IPOWER**

High Inrush peak currents up to 165A (20ms) and 800A (200µs)  
Mono-or bistable coil  
RTS3T: 5A Electronic ballast acc. UL508  
RTSET: 8A Electronic ballast acc. UL508  
Test tab (manual operator) optional for RTT3T bistable versions

**SCHRACK RP3SL**

Inrush peak currents up to 120A (20ms)  
Mono-or bistable coil  
Sealed version available

**Footprint**

2) see footnote below

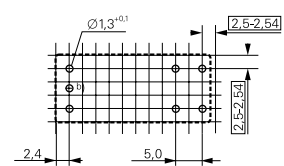
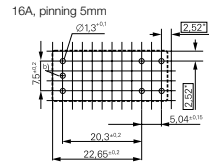
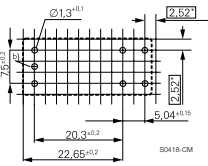

**Applications**

Lighting control systems  
Motion sensors  
Home automation applications

LED lighting systems, Lighting control, Movement detectors  
Filament and incandescent lamp  
Motor control

Lighting control  
Motor control  
Building automation

**Contact Data**

Contact arrangement	1 from A (NO)	1 from A (NO)	1 form A, 1 NO
Rated voltage	250VAC	250VAC	250VAC
Rated current	16A	16A	16A
Switching power / Max. break	4000VA	4000VA	4000VA
Contact material	W (pre-make contact) + AgSnO <sub>2</sub>	W (pre-make contact) + AgSnO <sub>2</sub>	AgSnO <sub>2</sub>
Min. recommended contact load	1) see footnote below	1) see footnote below	100mA at 12VDC

**Coil Data**

Magnetic system	Bistable	DC, bistable	DC
Rated coil voltage	5 to 48VDC	5 to 11VDC	6 to 110VDC
Rated coil power	650mW/665mW	400mW	500mW

**Dielectric Strength**

<b>Initial dielectric strength</b>			
between open contacts	1250Vrms	1250Vrms	2000Vrms
between contact and coil	5000Vrms	5000Vrms	4000Vrms
between adjacent contacts			
<b>Clearance/creepage</b>			
between contact and coil	min. 6/6mm	10/10mm	8/8mm

**Other Data**

Ambient temperature (max.)	+70°C	RTS3L/RTS3T +105°C, RTSET +85°C	+70°C
Category of environmental protection IEC61810	RTII	RTII	RTII, RTIII
Terminal type	THT	THT	THT
Mounting	PCB	PCB	PCB
Dimensions (lwh)	29.1x12.7x16mm	29x12.7x15.7mm (RTS3T), 29x12.7x16.0mm (RTS3L)	29x12.6x25.5mm

**Accessories**

<b>Link to datasheet</b>	<a href="#">SCHRACK RTX</a>	<a href="#">SCHRACK RT IPOWER</a>	<a href="#">SCHRACK RP3SL</a>
--------------------------	-----------------------------	-----------------------------------	-------------------------------

1) Recommended minimum load indication for contact material: AU and gold plated: 1mA at 6VDC; AgNi0.15 and AgNi90/10: 10mA at 12VDC; AgCdO and AgSnO<sub>2</sub>: 100mA at 12VDC. Please contact technical support for detailed technical data. 2) Footprint images are representative. For a complete selection, refer to the TE data sheet via the link above.





# Power PCB Relays up to 16A

## Relays, Contactors & Circuit Breakers

### Key Features

#### SCHRACK RP-2POLE 1.5MM

2 pole 8A  
1.5mm contact gap per pole  
Creepage distance complies with IEC 60950  
Sealed version available



#### SCHRACK PB/PBH

Compact and simple design gives high process security  
High ambient temperature version up to 105°C (PBH)  
WG type acc. IEC 60335-1



#### SCHRACK ORWH

Compact relay with 1 form A and 1 form C contact arrangement  
10A switching capacity



### Footprint

2) see footnote below

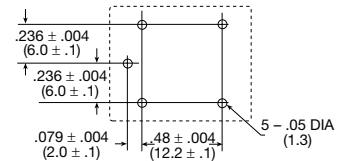
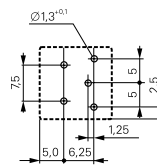
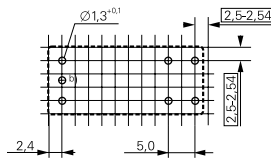

Applications	Domestic appliances UPS Solar Inverter	White goods Small home appliances Heating temperature controllers	Appliances HVAC Emergency lighting
<b>Contact Data</b>			
Contact arrangement	2 form A, 2 NO	1 form C (CO) 1 form A (NO)	1 form C (CO) 1 form A (NO)
Rated voltage	250VAC	250VAC	277VAC/28VDC
Rated current	8A	10A	10A
Switching power / Max. break	2000VA	2500VA	2770VA/360W
Contact material	AgSnO <sub>2</sub>	AgNi90/10, AgSnO	AgZnO, AgNi
Min. recommended contact load	100mA at 12VDC	1) see footnote below	100mA at 5VDC
<b>Coil Data</b>			
Magnetic system	DC	DC	DC
Rated coil voltage	5 to 110VDC	5 to 48VDC	5 to 24VDC
Rated coil power	780mW	360mW/500mW	360mW
<b>Dielectric Strength</b>			
<b>Initial dielectric strength</b>			
between open contacts	25000Vrms	1000Vrms	750Vrms
between contact and coil	5000Vrms	2500Vrms	1500Vrms
between adjacent contacts	300Vrms		
<b>Clearance/creepage</b>			
between contact and coil	7/8mm	3/4mm / 4/5mm	3.2mm
<b>Other Data</b>			
Ambient temperature (max.)	+40°C	+85°C/+105°C	+85°C
Category of environmental protection IEC61810	RTII, RTIII	RTII	RTII, RTIII
Terminal type	THT	THT	THT
Mounting	PCB	PCB	PCB
Dimensions (lwh)	29x12.6x25.5mm	15x15x20mm	19.0x15.5x15.8mm
<b>Accessories</b>			
Link to datasheet	<a href="#">SCHRACK RP-2POLE 1.5MM</a>	<a href="#">SCHRACK PB</a> <a href="#">SCHRACK PBH</a>	<a href="#">SCHRACK ORWH</a>

1) Recommended minimum load indication for contact material: AU and gold plated: 1mA at 6VDC; AgNi015 and AgNi90/10: 10mA at 12VDC; AgCdO and AgSnO<sub>2</sub>: 100mA at 12VDC. Please contact technical support for detailed technical data. 2) Footprint images are representative. For a complete selection, refer to the TE data sheet via the link above.

# Power PCB Relays up to 50A+

Relays, Contactors & Circuit Breakers

## Key Features

### Potter & Brumfield T9G

High breaking capacity  
PCB and quick connect connections  
4kV/8mm coil-contact  
Minimum board space  
(29mm x 21.5mm)  
UL-class F as standard

### Potter & Brumfield T9A

High breaking capacity  
PCB and quick connect and chassis mount version  
UL-class F as standard  
Open version available

### Potter & Brumfield T9S/T9V

1 pole 35A (T9S)/40A (T9V)  
Contact gap 1.5mm/1.8mm min.  
Ambient temperature up to 85°C at 35A  
Production in accordance to IEC 60335-1  
RoHS compliant (Directive 2002/95/EC)

## Footprint

2) see footnote below

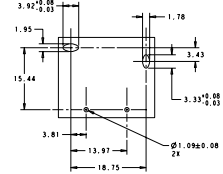
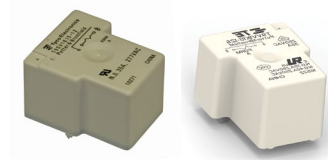
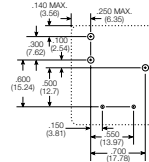
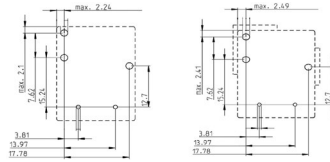

Applications	HVAC, Appliances Industrial control Energy management	HVAC Appliances Industrial controls	Photovoltaic inverter Electrical vehicle loading stations Electrical vehicle
<b>Contact Data</b>			
Contact arrangement	1 form C (1 CO) 1 form B (1 NC) 1 form A (1 NO)	1 form C (1 CO) 1 form B (1 NC) 1 form A (1 NO)	1 form A (1NO)
Rated voltage	250VAC	250VAC	277VAC (1.5mm gap), 250VAC (1.8mm gap)
Rated current	30A	30A	35A (T9S), 40A (T9V)
Switching power / Max. break		7500VA	9695VA (T9S), 10000VA (T9V)
Contact material	AgSnO <sub>2</sub>	AgCdO, AgSnInO	AgNi
Min. recommended contact load	1A at 12VAC/VDC	1A at 5VDC or 12VAC	1A at 5VDC/12VAC
<b>Coil Data</b>			
Magnetic system	DC	DC	Monostable
Rated coil voltage	5 to 110VDC	6 to 48VDC	12VDC
Rated coil power	900mW	1W/900mW	2.25W
<b>Dielectric Strength</b>			
Initial dielectric strength			
between open contacts	1500Vrms	1500Vrms	2500Vrms
between contact and coil	4000Vrms	2500Vrms	4000Vrms
between adjacent contacts			
Clearance/creepage	6.4mm / 9.5mm (UL)		
between contact and coil	8mm / 8mm (IEC)	3.1/6.3mm	3/4mm
<b>Other Data</b>			
Ambient temperature (max.)	+105°C	+85°C	+85°C
Category of environmental protection IEC61810	RTII, RTIII	RTO, RTI, RTII, RTIII	RTII/RTIII
Terminal type	THT/Quick connect	THT/Quick connect	PCB
Mounting	PCB	PCB, panel mount	PCB
Dimensions (lwh)	29x21.5x15.7mm	32.3x27.4x20.4mm	32x27x20mm
<b>Accessories</b>			
Link to datasheet	<a href="#">Potter &amp; Brumfield T9G</a>	<a href="#">Potter &amp; Brumfield T9A</a>	<a href="#">Potter &amp; Brumfield T9V</a> <a href="#">Potter &amp; Brumfield T9S</a>

1) Recommended minimum load indication for contact material: AU and gold plated: 1mA at 6VDC; AgNi0.15 and AgNi90/10: 10mA at 12VDC; AgCdO and AgSnO<sub>2</sub>: 100mA at 12VDC. Please contact technical support for detailed technical data. 2) Footprint images are representative. For a complete selection, refer to the TE data sheet via the link above.

# Power PCB Relays up to 50A+

Relays, Contactors & Circuit Breakers

## Key Features

### Potter & Brumfield T92

Switching capacity 7500VA  
DC or AC coil  
4kV/8mm coil-contact  
PCB or quick connect connections  
or chassis mount



### PCF

Quick connect terminal for load (PCF only)  
Height 26.5mm  
Meet 4kV dielectric voltage between coil and contact  
Ambient temperature 85°C



### PCFN SOLAR

Specially designed to meet the requirements for solar  
Contact gap 1.5mm/1.8mm min.  
200mW hold power



## Footprint

2) see footnote below

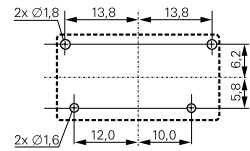
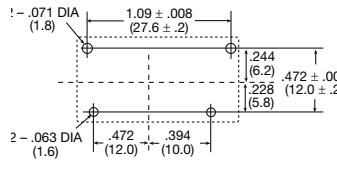
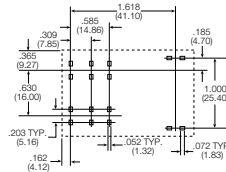

Applications	HVAC Residential/commercial appliances Industrial controls	Appliances HVAC Office machines	Photovoltaic Inverter
<b>Contact Data</b>			
Contact arrangement	2 form C (2 CO) 2 form A (2 NO)	1 form A (1 NO)	1 form A (1 NO)
Rated voltage	400VAC	250VAC	277VAC
Rated current	30A	25A	26A
Switching power / Max. break	7500VAC	6370VA	7200VA
Contact material	AgCdO, AgSnInO	Visit <a href="http://TE.com">TE.com</a> for more information	AgSnO <sub>2</sub>
Min. recommended contact load	500mA (NO)/ 100mA (NC) at 12VAC	100mA at 5VDC	100mA at 5VDC
<b>Coil Data</b>			
Magnetic system	DC, AC	DC	DC
Rated coil voltage	5 to 110VDC/12 to 240VAC	6 to 24VDC	12VDC and 24VDC
Rated coil power	1.7W/4.0VA	900mW	1.5W/200mW hold power
<b>Dielectric Strength</b>			
Initial dielectric strength			
between open contacts	1500Vrms	1000Vrms	2500Vrms
between contact and coil	4000Vrms	4000Vrms	4000Vrms
between adjacent contacts	2000Vrms		
Clearance/creepage			
between contact and coil	8/9.5mm	6.7/>8mm	6.1/6.1mm
<b>Other Data</b>			
Ambient temperature (max.)	DC Coil +85°C; AC Coil +65°C	+85°C	+85°C
Category of environmental protection IEC61810	RTI, RTII, RTIII	RTII	RTII
Terminal type	THT/Quick connect	THT/Quick connect (#250)	PCB-THT
Mounting	Panel mount, PCB	PCB	PCB
Dimensions (lwh)	52.3x34.6x30.8mm	30.4x16x26.5mm	30.4x16x26.5mm
<b>Accessories</b>			
Link to datasheet	<a href="#">Potter &amp; Brumfield T92</a>	<a href="#">PCF</a>	<a href="#">PCFN SOLAR</a>

1) Recommended minimum load indication for contact material: AU and gold plated: 1mA at 6VDC; AgNi0.15 and AgNi90/10: 10mA at 12VDC; AgCdO and AgSnO<sub>2</sub>: 100mA at 12VDC. Please contact technical support for detailed technical data. 2) Footprint images are representative. For a complete selection, refer to the TE data sheet via the link above.

# Power PCB Relays up to 50A+

Relays, Contactors & Circuit Breakers

## Key Features

### EW60

1 pole 60A, 1 form A (NO) contact  
Polarized bistable (latching) with 1 or 2 coils  
NEMA 410-2011, 16A, 277VAC, electronic ballast;  
20A branch circuit  
480A inrush, 2.1m sec



### EW100/120

1 pole 120A, 1 form A (NO) contact  
Polarized bistable with two coils latching  
4KV/ 8mm coil - contact  
Reinforced insulation



## Footprint

2) see footnote below

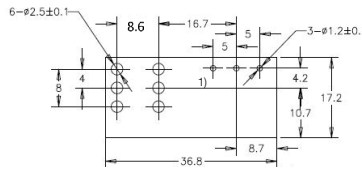

Visit [TE.com](http://TE.com) for more information

## Applications

Lighting control, bus actuator,  
power distribution, circuit protection, inverter

Energy counter, prepaid power meter

## Contact Data

Contact arrangement	1 form A (1 NO)	1 form A (1 NO)
Rated voltage	440VAC	250VAC
Rated current	60A	100A/120A
Switching power / Max. break	15000VA	30000VA
Contact material	AgSnO <sub>2</sub>	AgSnO <sub>2</sub>
Min. recommended contact load	Visit <a href="http://TE.com">TE.com</a> for more information	Visit <a href="http://TE.com">TE.com</a> for more information

## Coil Data

Magnetic system	Bistable	Bistable
Rated coil voltage	5 to 24VDC	6 to 24VDC
Rated coil power	1.5W/3W	4.5W

## Dielectric Strength

Initial dielectric strength		
between open contacts	1500Vrms	2000Vrms
between contact and coil	4000Vrms	4000Vrms
between adjacent contacts		
Clearance/creepage		
between contact and coil	≥6/9mm	≥10/10mm

## Other Data

Ambient temperature (max.)	+70°C	+70°C
Category of environmental protection IEC61810	RTI	RTII - flux proof
Terminal type	PCB	PCB, Copper
Mounting	PCB	Visit <a href="http://TE.com">TE.com</a> for more information
Dimensions (lwh)	36.8x17.2x30.4mm	36.8x21.8x41.9mm

## Accessories

Link to datasheet	<a href="#">EW60</a>	<a href="#">EW100/120</a>
-------------------	----------------------	---------------------------

1) Recommended minimum load indication for contact material: AU and gold plated: 1mA at 6VDC; AgNi0.15 and AgNi90/10: 10mA at 12VDC; AgCdO and AgSnO<sub>2</sub>: 100mA at 12VDC. Please contact technical support for detailed technical data. 2) Footprint images are representative. For a complete selection, refer to the TE data sheet via the link above.

# Power PCB Relays up to 50A+

Relays, Contactors & Circuit Breakers

## Key Features

### IHV

Hermetically sealed - intrinsically safe  
Designed accordance to AIAG QS9000  
No position sensitive  
RoHS compliance



PCB mount not applicable.  
Visit [TE.com](http://TE.com) for more information

### Potter & Brumfield PRD

Contact ratings to 50A  
Magnetic blowout available for switching DC loads  
SPDT auxiliary switch available  
Class B insulation system

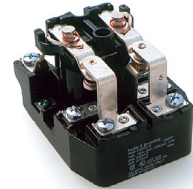

PCB mount not applicable.  
Visit [TE.com](http://TE.com) for more information

## Applications

DC charging, Solar inverter, Energy store station  
BMS, Electrical forklift, AGV, Rail transit  
Circuit protection and Safety in Industrial Machinery

Industrial controls  
Lighting

## Contact Data

Contact arrangement	1 form X	1 form A (1 NO) 1 form C (1 CO) 1 form X (NO-DM) 2 form A (2 NO) 2 form C (2 CO)
Rated voltage	450VDC / 750VDC	600VAC, 28/125VDC
Rated current	50A/100A/150A/200A/250A/350A	50A
Switching power / Max. break		12000VA
Contact material		Ag, AgCdO
Min. recommended contact load	Visit <a href="http://TE.com">TE.com</a> for more information	1A at 12VDC/VAC

## Coil Data

Magnetic system	DC	DC, AC
Rated coil voltage	12VDC, 24VDC or PWM	6 to 110VDC/6 to 480VAC
Rated coil power	Visit <a href="http://TE.com">TE.com</a> for more information	2W/9.8VA

## Dielectric Strength

Initial dielectric strength		2000Vrms
between open contacts		2000Vrms
between contact and coil	2000Vrms	2000Vrms
between adjacent contacts		2000Vrms
Clearance/creepage		
between contact and coil	Visit <a href="http://TE.com">TE.com</a> for more information	>8mm

## Other Data

Ambient temperature (max.)	+85°C	DC +80°C AC +45°C
Category of environmental protection IEC61810	RTV	RT 0/open
Terminal type	Screw	Screw/Quick connect
Mounting	Panel mount	Panel mount
Dimensions (lwh)	Visit <a href="http://TE.com">TE.com</a> for more information	85.7X63.8X63.5mm

## Accessories

Dust cover

## Link to datasheet

[Potter & Brumfield PRD](#)

1) Recommended minimum load indication for contact material: AU and gold plated: 1mA at 6VDC; AgNi0.15 and AgNi90/10: 10mA at 12VDC; AgCdO and AgSnO<sub>2</sub>: 100mA at 12VDC. Please contact technical support for detailed technical data.

# Force Guided Relays

Relays, Contactors & Circuit Breakers

## Key Features

### SCHRACK SR2M

2 pole relay with force guided contacts according to EN50205  
Reinforced insulation between poles

### SCHRACK SR4 D/M

4 pole relay with force guided contacts according to EN50205  
Compact design, space efficient



## Footprint

2) see footnote below

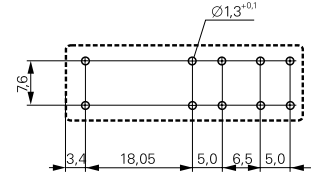
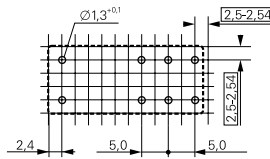

Applications	Safety modules Process technology Elevator and Escalator control	Safety modules Process technology Elevator and Escalator control
<b>Contact Data</b>		
Contact arrangement	1 form A + 1 form B (1 NO + 1 NC) 2 form C (2 CO)	3 form A + 1 form B (3 NO + 1 NC) 2 form A + 2 form B (2 NO + 2 NC)
Rated voltage	250VAC	250VAC
Rated current	6A	8A
Switching power / Max. break	1500VA	2000VA
Contact material	AgNi	AgSnO <sub>2</sub>
Min. recommended contact load	10mA at 5VDC	10mA at 5VDC
<b>Coil Data</b>		
Magnetic system	DC	DC
Rated coil voltage	5 to 110VDC	5 to 110VDC
Rated coil power	700mW	800mW
<b>Dielectric Strength</b>		
Initial dielectric strength		
between open contacts	1500Vrms	1500Vrms
between contact and coil	4000Vrms	4000Vrms
between adjacent contacts	3000Vrms	2500Vrms
Clearance/creepage		
between contact and coil	8/8mm	10/10mm
<b>Other Data</b>		
Ambient temperature (max.)	+70°C	+70°C
Category of environmental protection IEC61810	RTIII	RTIII
Terminal type	THT/Plug-in	THT
Mounting	PCB/Socket	PCB
Dimensions (lwh)	29x12.6x25.5mm	40x13x16.5mm
<b>Accessories</b>	Sockets and relay clips	
<b>Link to datasheet</b>	<a href="#">SCHRACK SR2M</a>	<a href="#">SCHRACK SR4 D/M</a>

1) Recommended minimum load indication for contact material: AU and gold plated: 1mA at 6VDC; AgNi0.15 and AgNi90/10: 10mA at 12VDC; AgCdO and AgSnO<sub>2</sub>: 100mA at 12VDC. Please contact technical support for detailed technical data. 2) Footprint images are representative. For a complete selection, refer to the TE data sheet via the link above.



# Panel Plug-In Relays

Relays, Contactors & Circuit Breakers

## Key Features

### SCHRACK SLIM INTERFACE SNR

Strong coil pins for DIN-rail socket  
LED and protection circuit standard  
4kV coil-contact, 6/8mm clearance/  
creepage  
System width only 6.2mm

### SCHRACK INTERFACE RELAY RT

Strengthened pins designed to plug  
into DIN-rail-sockets  
Cadmium-free contacts  
Complete interface solutions available  
Modular concept socket/relay/module

### SCHRACK INTERFACE RELAY XT

Manual test tab, optionally lockable  
Mechanical and electrical indicator  
Reinforced insulation  
4kV/8mm dielectric strength between  
coil and contact

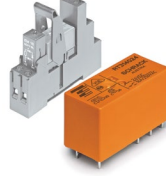

## Footprint

2) see footnote below

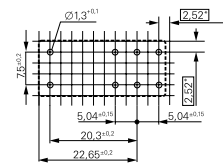
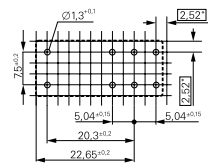
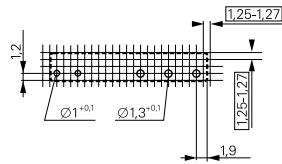

Applications	Interface technology Panel board Mechanical engineering	Panel board Mechanical engineering Machine Industry	Panel boards Mechanical engineering
<b>Contact Data</b>			
Contact arrangement	1 form C, (CO)	1 form C, (1 CO) 2 form C, (2 CO)	1 form C, (1 CO) 2 form C, (2 CO)
Rated voltage	250VAC	240VAC	240VAC
Rated current	6A	8/16A	8/16A
Switching power / Max. break	1500VA	2000/4000VA	2000/4000VA
Contact material	AgSnO <sub>2</sub> , AgSnO <sub>2</sub> Au plated	AgSnO <sub>2</sub> , AgNi90/10 AgNi90/10 Au plated	AgNi90/10
Min. recommended contact load	1) see footnote below	1) see footnote below	10mA at 12VDC
<b>Coil Data</b>			
Magnetic system	DC	DC, AC	DC, AC
Rated coil voltage	5 to 60VDC	5 to 110VDC/24 to 230VAC	12 to 110VDC/24 to 230VAC
Rated coil power	170mW	400mW/0.75VA	400mW/0.75VA
<b>Dielectric Strength</b>			
<b>Initial dielectric strength</b>			
between open contacts	1000Vrms	1000Vrms	1000Vrms
between contact and coil	4000Vrms	4000/5000Vrms	4000/5000Vrms
between adjacent contacts		2500Vrms	2500Vrms
<b>Clearance/creepage</b>			
between contact and coil	≥6/8mm	≥8/8mm	≥8/8mm
<b>Other Data</b>			
Ambient temperature (max.)	Relay +85°C, in socket +55°C	+70/+85°C	+70/+85°C
Category of environmental protection IEC61810	RTIII	RTII	RTII
Terminal type	Plug-in	Plug-in	Plug-in
Mounting	Socket	Socket	Socket
Dimensions (lwh)	28x5x15mm	29x13x15.7mm	29x13x26.7mm
<b>Accessories</b>			
	DIN rail sockets, jumper bars	DIN rail and PCB sockets, clips, marking tags, modules, jumper bars	DIN rail and PCB sockets, clips, marking tags, modules, jumper bars
<b>Link to datasheet</b>	<a href="#">SCHRACK SLIM INTERFACE SNR</a>	<a href="#">SCHRACK INTERFACE RELAY RT</a>	<a href="#">SCHRACK INTERFACE RELAY XT</a>

1) Recommended minimum load indication for contact material: AU and gold plated: 1mA at 6VDC; AgNi015 and AgNi90/10: 10mA at 12VDC; AgCdO and AgSnO<sub>2</sub>: 100mA at 12VDC. Please contact technical support for detailed technical data. 2) Footprint images are representative. For a complete selection, refer to the TE data sheet via the link above.



# Panel Plug-In Relays

Relays, Contactors & Circuit Breakers

## Key Features

**Potter & Brumfield R10**  
 Broad range of coil options provide sensitivity ranging from 25 to 750mW  
 Various contacts switch from dry circuit to 7.5A  
 Many mounting and termination options

**SCHRACK PT/  
 Potter & Brumfield KH**  
 Sensitive coil  
 Low height 29/33mm  
 Manual test tab, optionally lockable  
 Mechanical indicator  
 Optional LED, protection diode

**Potter & Brumfield K10**  
 Mounting options include socket, PCB, top flange  
 DC and AC coils  
 LED versions available



## Footprint

2) see footnote below

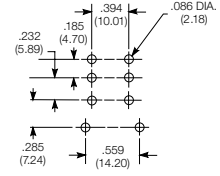
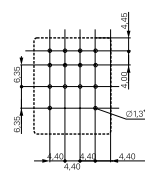
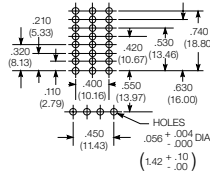

Applications	Coin changers Audio equipment Ultrasonic test equipment	Machine industry Elevator industry Building management	Industrial controls Motor controls Industrial timers
<b>Contact Data</b>			
Contact arrangement	1, 2, 3, 4, 6, 8 form C (CO)	2 form C (2 CO) 3 form C (3 CO) 4 form C (4 CO)	2 form C (2 CO)
Rated voltage	115VAC, 115VDC	240VAC	120/240VAC
Rated current	0.5/2/3/7.5A	1/2/5/6/10/12A	10/15A
Switching power / Max. break	862VA max.	1500/2500/3000VA	1800/2500VA
Contact material	Ag, AgCdO, Ag w/ Au overlay	AgNi90/10, AgNi90/10 Au plated	AgCdO, AgNi90/10
Min. recommended contact load	Dry circuit to 300mA at 12VDC	1) Bifurcated contacts for dry circuit available on KH	1) see footnote below
<b>Coil Data</b>			
Magnetic system	DC, AC	DC, AC	DC, AC
Rated coil voltage	3 to 115VDC/6 to 115VAC	6 to 220VDC/6 to 240VAC	6 to 220VDC/6 to 240VAC
Rated coil power	36mW to 1.6W/1.5VA	750 to 900mW/1 to 1.2VA	750 to 900mW/1 to 1.2VA
<b>Dielectric Strength</b>			
<b>Initial dielectric strength</b>			
between open contacts	500/1000Vrms	1200Vrms	1200/1000Vrms
between contact and coil	1000Vrms	2500Vrms	2500/1500Vrms
between adjacent contacts	1000Vrms	2000/2500Vrms	2500/1500Vrms
<b>Clearance/creepage</b>			
between contact and coil	Visit <a href="http://TE.com">TE.com</a> for more information	≥4/4mm	≥3.1/3.1mm
<b>Other Data</b>			
Ambient temperature (max.)	+75°C	+70°C	+70°C
Category of environmental protection IEC61810	RTI, RTIII	RTII	RTII
Terminal type	Solder/plug-in and PCB	THT, plug-in, Quick connect	Quick connect, solder, PCB
Mounting	Socket, panel mount and PCB	Socket, PCB	Socket and bracket mount
Dimensions (lwh)	29.6x18.7x30.2mm	28x22.5x29/30/36mm	28x22.5x29/34.9mm
<b>Accessories</b>			
	Solder/PCB sockets, clips, hold down strap, mounting strip	DIN rail and PCB sockets, clips, marking tags, modules, jumper bars	Screw, solder and PCB sockets and clips
<b>Link to datasheet</b>			
	<a href="#">Potter &amp; Brumfield R10</a>	<a href="#">Potter &amp; Brumfield KHA SCHRACK PT</a>	<a href="#">Potter &amp; Brumfield K10</a>

1) Recommended minimum load indication for contact material: AU and gold plated: 1mA at 6VDC; AgNi0.15 and AgNi90/10: 10mA at 12VDC; AgCdO and AgSnO<sub>2</sub>: 100mA at 12VDC. Please contact technical support for detailed technical data. 2) Footprint images are representative. For a complete selection, refer to the TE data sheet via the link above.

# Panel Plug-In Relays

Relays, Contactors & Circuit Breakers

## Key Features

### Potter & Brumfield KRPA/MT

Industry standard octal/undecal type termination for quick installation  
DC and AC coils  
Mechanical indicator, indicator lamp and push-to-test options



### SCHRACK RM2/3/7

Wide selection of termination and mounting styles  
PC terminals available  
Push to test button and indicator lamps  
Class B coil insulation

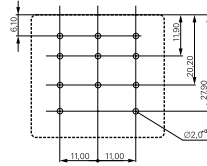

### Potter & Brumfield KUP/KUMP/KUIP

Wide selection of termination and mounting styles  
Broad range of contact forms  
PC terminals available  
Push to test button and indicator lamps  
Class B coil insulation

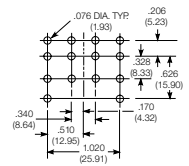

## Footprint

2) see footnote below

PCB mount not applicable. Visit [TE.com](http://TE.com) for more information

Applications	Mechanical engineering Elevator control, Plant control Baggage handling	Elevator control Power supplies	HVAC Pump motor controls Hospital beds
<b>Contact Data</b>			
Contact arrangement	1 form C (1 CO) (KRPA) 2 form C (2 CO) 3 form C (3 CO)	2 form C (2 CO) 3 form C (3 CO)	1, 2, 3, 4 form C (CO) 1, 2, 3 form A (NO) 2, 3 form B (NC) 1 form X (NO-DM) 1 form Y (NC-DB) 1 form Z (CO-DM/DB)
Rated voltage	240VAC	400VAC	240VAC
Rated current	4/10A	10/16A	10/15A
Switching power / Max. break	500/2400/2500VA	3800/6000VA	2400/4155VA
Contact material	AgCdO, AgNi90/10, AgNi90/10 Au plated	AgCdO, AgNi90/10 in preparation	Ag, AgCdO, AgSnOInO
Min. recommended contact load	1) see footnote below	100mA at 12VDC	100mA at 12VDC(Ag) 300mA at 12VDC (AgCdO, AnSnOInO)
<b>Coil Data</b>			
Magnetic system	DC, AC	DC, AC	DC, AC
Rated coil voltage	6 to 220VDC/6 to 240VAC	6 to 220VDC/6 to 400VAC	5 to 110VDC/6 to 240VAC
Rated coil power	760mW to 1.3W/0.74 to 2.3VA	1.2 to 1.8W/2 to 2.8VA	1.2 to 1.8W/2 to 2.7VA
<b>Dielectric Strength</b>			
Initial dielectric strength			
between open contacts	1000/1500Vrms	1500Vrms	1200Vrms
between contact and coil	1000/2500Vrms	2500Vrms	2200/3750Vrms
between adjacent contacts	1000/2500Vrms	2500Vrms	2200Vrms
Clearance/creepage			
between contact and coil	≥2.8/4mm	≥4/14.9mm	Visit <a href="http://TE.com">TE.com</a> for more information
<b>Other Data</b>			
Ambient temperature (max.)	DC +60/+70°C AC +50/+55°C	+50/+70°C	DC +50/+70/+95°C AC +45/+55/+70°C
Category of environmental protection IEC61810	RTI	RTI	RTI
Terminal type	Plug-in	THT, Plug-in, solder, Quick connect	THT, Plug-in, solder, Quick connect
Mounting	Socket	Socket, PCB, bracket, flange mount and DIN-snap-on	Socket, PCB, bracket, flange, stud and tapped core
Dimensions (lwh)	35.7x35.7x50.8/57mm	38.5x35.5x48.5mm	38.9x35.7x48.4mm
<b>Accessories</b>	DIN rail and PCB sockets, clips, marking tags, modules	DIN rail and PCB sockets, clips	DIN rail, panel and PCB sockets, clips
<b>Link to datasheet</b>	<a href="#">Potter &amp; Brumfield KRPA</a> <a href="#">SCHRACK MT</a>	<a href="#">SCHRACK RM2/3/7</a>	<a href="#">Potter &amp; Brumfield KUIP KUGP</a> <a href="#">KUM KUMP KUP</a>

1) Recommended minimum load indication for contact material: AU and gold plated: 1mA at 6VDC; AgNi015 and AgNi90/10: 10mA at 12VDC; AgCdO and AgSnO<sub>2</sub>: 100mA at 12VDC. Please contact technical support for detailed technical data. 2) Footprint images are representative. For a complete selection, refer to the TE data sheet via the link above.



# Panel Plug-In Relays

## Relays, Contactors & Circuit Breakers

### Key Features

#### SCHRACK RM8/C/D

Power relay with push-on and solder terminals  
 Various mounting options  
 Indicator lamps and mechanical indicator  
 Optional push to test button



#### Potter & Brumfield KUHP

Power relay with push-on and solder terminals  
 Various mounting options  
 Designed to meet VDE space requirements  
 Class B coil insulation

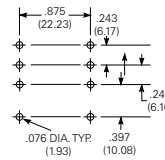

#### SCHRACK RM5/6/B 3MM

3mm contact gap  
 DC or AC coil  
 Push-to-test button  
 Plug-in version, PCB terminals or chassis or DIN-rail mount

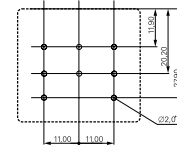

### Footprint

2) see footnote below

PCB mount not applicable.  
 Visit [TE.com](http://TE.com) for more information

Applications	Cleaning equipment Heating equipment Cooling equipment	Baggage handling motors Industrial pumps Commercial ovens	Power supplies Pump control
--------------	--	---	--------------------------------

### Contact Data

Contact arrangement	1 form C (1 CO) 2 form C (2 CO) 1 form Z contact (1 NO + 1 NC) 1 form X contact (1 NO)	1 form C (1 CO) 2 form C (2 CO)	2 form A (2 NO) 3 form A (3NO)
Rated voltage	400VAC	240VAC, 50/60Hz; 28VDC	240/400VAC
Rated current	25/30/32A	20/30A	10/16A
Switching power / Max. break	6000/7500VA	4800/7200VA	3800/6000VA
Contact material	AgCdO, AgNi90/10	AgCdO, AgSnOInO	AgCdO, AgNi90/10 in preparation
Min. recommended contact load	100mA at 12VDC	300mA at 12VDC	100mA at 12VDC

### Coil Data

Magnetic system	DC, AC	DC, AC	DC, AC
Rated coil voltage	6 to 220VDC/6 to 400VAC	6 to 110VDC 50/60Hz. 6 to 277VAC	6 to 220VDC/6 to 400VAC
Rated coil power	1.2W/2.7VA	1.2W/2.7VA	1.2W/2.7VA

### Dielectric Strength

Initial dielectric strength			
between open contacts	1500/2000Vrms	1200Vrms	2500Vrms
between contact and coil	2500Vrms	3750Vrms	2500Vrms
between adjacent contacts	4000Vrms	3750Vrms	2500Vrms
Clearance/creepage			
between contact and coil	≥4/14.9mm	Visit <a href="http://TE.com">TE.com</a> for more information	≥4/14.9mm

### Other Data

Ambient temperature (max.)	DC +60/+65°C AC +40°C	DC +45°C AC +75°C	+50/+60°C
Category of environmental protection IEC61810	RTI	RTI, RTO	RTI
Terminal type	Solder/Quick connect	Solder/PCB THT/Quick connect	Plug-in, solder, Quick connect, PCB THT
Mounting	Bracket, top flange panel mount and DIN snap-on	Bracket and top flange panel mount	Socket, PCB, bracket, flange mount and DIN-snap-on
Dimensions (lwh)	38.5x35.5x48.5mm	38.9x35.7x48.4mm	38.5x35.5x48.5mm
Accessories	No sockets	No sockets	DIN rail and PCB sockets, clips

Link to datasheet	<a href="#">SCHRACK RM8C/D</a> <a href="#">SCHRACK RM 8</a>	<a href="#">Potter &amp; Brumfield KUHP</a>	<a href="#">SCHRACK RM5/6/B 3MM</a>
-------------------	--	---	-------------------------------------

1) Recommended minimum load indication for contact material: AU and gold plated: 1mA at 6VDC; AgNi015 and AgNi90/10: 10mA at 12VDC; AgCdO and AgSnO<sub>2</sub>: 100mA at 12VDC. Please contact technical support for detailed technical data. 2) Footprint images are representative. For a complete selection, refer to the TE data sheet via the link above.

# Panel Plug-In Relays

Relays, Contactors & Circuit Breakers

## Key Features

### Potter & Brumfield KUGP

3mm contact gap  
DC or AC coil  
Plug-in version, PCB terminals or chassis mount

### Potter & Brumfield KUL

Magnetic latching  
Single and dual coils  
Panel mounting

### Potter & Brumfield KUEP

10A relay with various contact arrangements  
Magnetic blowout for 150VDC load switching  
Indicator lamp option

## Footprint

2) see footnote below

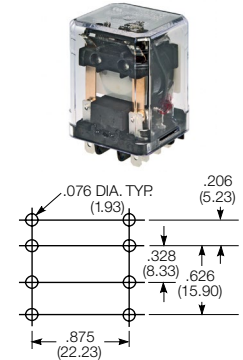
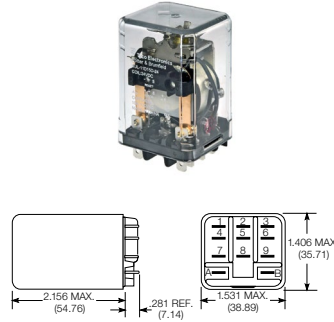
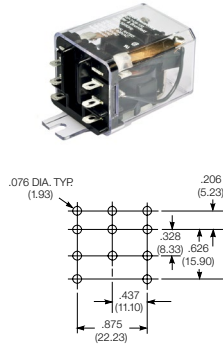

## Applications

Voltage control units

Alarm systems  
Machine tools  
Battery chargers

DC load switching in industrial controls

## Contact Data

Contact arrangement	1 form C (1 CO) 2 form A (2 NO) 2 form C (2 CO) 3 form C (3 CO)	1 form C (1 CO) 2 form C (2 CO) 3 form C (3 CO)	1 form X (NO-DM) 2 form A (2 NO) 2 form C (2 CO)
Rated voltage	240/400VAC	28/240VAC	150VDC/240VAC
Rated current	10A	10A	10A
Switching power / Max. break	2400VA		1500W/2400VA
Contact material	Ag, AgCdO	Ag, AgCdO	AgCdO, AgSnOInO
Min. recommended contact load	100mA at 12VDC (Ag) 300mA at 12VDC (AgCdO)	100mA at 12VDC (Ag) 300mA at 12VDC (AgCdO)	300mA at 12VDC

## Coil Data

Magnetic system	DC, AC	DC, AC	DC, AC
Rated coil voltage	6-110VDC/6-240VAC	12 to 48VDC/24 to 120/240VAC	5 to 110VDC/6 to 240VAC
Rated coil power	1.8W/2.7VA	1.6W dual coil/1.2W single coil	1.2W to 1.8W/2 to 2.7VA

## Dielectric Strength

Initial dielectric strength			
between open contacts	3500Vrms	500Vrms	1200Vrms
between contact and coil	2200Vrms	1500Vrms	2200Vrms
between adjacent contacts	2200Vrms	1500Vrms	2200Vrms
Clearance/creepage			
between contact and coil	>8mm	Visit <a href="http://TE.com">TE.com</a> for more information	Visit <a href="http://TE.com">TE.com</a> for more information

## Other Data

Ambient temperature (max.)	DC +75°C AC +70°C	DC +70°C AC +50/+70°C	AC +55/+70°C DC +50/+70°C
Category of environmental protection IEC61810	RTI	RTI	RTI
Terminal type	THT, Plug-in, solder, Quick connect, PCB	.187 Quick connect, solder	Quick connect, solder and PCB
Mounting	Socket, PCB, bracket, flange mount	Socket, bracket	Socket, PCB, bracket and top flange mount
Dimensions (lwh)	38.9x35.7x48.4mm	38.9x35.7x54.8mm	38.9x35.7x48.4mm

## Accessories

DIN rail and PCB sockets, clips

Screw, solder, PCB and Quick connect sockets and clips

DIN rail, track mount, chassis mount, and snap-in sockets, clips

## Link to datasheet

[Potter & Brumfield KUGP](#)

[Potter & Brumfield KUL](#)

[Potter & Brumfield KUEP](#)

1) Recommended minimum load indication for contact material: AU and gold plated: 1mA at 6VDC; AgNi0.15 and AgNi90/10: 10mA at 12VDC; AgCdO and AgSnO<sub>2</sub>: 100mA at 12VDC. Please contact technical support for detailed technical data. 2) Footprint images are representative. For a complete selection, refer to the TE data sheet via the link above.



# Panel Plug-In Relays

Relays, Contactors & Circuit Breakers

## Key Features

### ACCESSORIES

DIN rail and PCB sockets  
Screw and screwless fingersafe terminals  
Retaining and ejection clips  
Marking tags, jumper bars, jumper links  
LED and protection modules

### SETS

Relay package consisting of relay, DIN rail socket, plastic retaining clip, marking tag and module

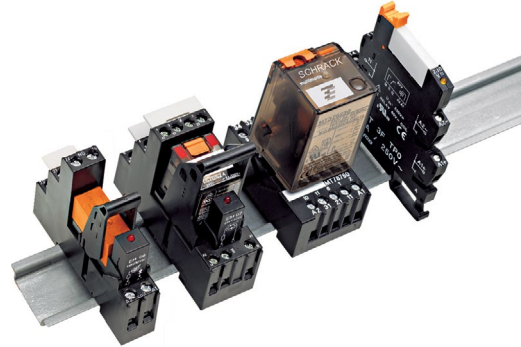

## Applications

### Contact Data

Contact arrangement	1 form C (1 CO) 2 form C (2 CO) 3 form C (3 CO) 4 form C (4 CO)	1 form C (1 CO) 2 form C (2 CO) 3 form C (3 CO) 4 form C (4 CO)
Rated voltage	240/250VAC	240/250VAC
Rated current	6 to 16A	6 to 16A
Switching power / Max. break		1500 to 4000VA
Min. recommended contact load		1) see footnote below

### Coil Data

Magnetic system	DC, AC
Rated coil voltage	6 to 220VDC/6 to 230VAC
Rated coil power	170 to 700mW/0.4 to 1VA

### Dielectric Strength

Initial dielectric strength  
between open contacts  
between contact and coil  
between adjacent contacts  
Clearance/creepage  
between contact and coil

### Other Data

Ambient temperature (max.)		
Category of environmental protection IEC61810	IP20	
Terminal type	Screw, screwless, plate mount, PCB	Screw, screwless
Mounting		
Dimensions (lwh)		

Accessories	PCB, panel mount and DIN rail	DIN, panel mount
-------------	-------------------------------	------------------

Link to datasheet	<a href="#">ACCESSORIES SLIM INTERFACE RELAY SNR</a> <a href="#">ACCESSORIES INDUSTRIAL POWER RELAY RT</a> <a href="#">ACCESSORIES MINIATURE RELAY PT</a> <a href="#">ACCESSORIES INTERFACE PLUG-IN RELAY XT</a>	<a href="#">RELAY PACKAGE RT</a> <a href="#">RELAY PACKAGE PT</a> <a href="#">RELAY PACKAGE SNR</a> <a href="#">ACCESSORIES MULTIMODE RELAY MT</a>
-------------------	---	---

1) Recommended minimum load indication for contact material: AU and gold plated: 1mA at 6VDC; AgNi0.15 and AgNi90/10: 10mA at 12VDC; AgCdO and AgSnO<sub>2</sub>: 100mA at 12VDC. Please contact technical support for detailed technical data.

# Signal Relays

## Relays, Contactors & Circuit Breakers

### Key Features

#### Axicom IM

4G telecom/signal relay/switching relay  
Slim line 10x6mm, low-profile 5.65mm  
Switching power 60W/62.5VA  
Switching voltage 220VDC/250VAC  
Monostable + Bistable  
Low rated coil power  
High dielectric version  
High current version up to 5 A  
High contact stability version  
Bifurcated contacts + single contact

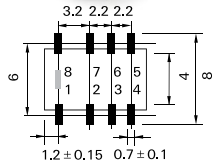
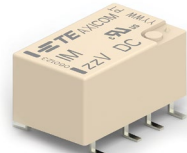

#### Axicom IMB

4G telecom/signal relay/switching relay  
Slim line 10x6mm, low-profile 5.65mm  
Switching power 60W/62.5VA  
Switching voltage 220VDC/250VAC  
Monostable + Bistable  
Very high dielectric version  
Bifurcated contacts

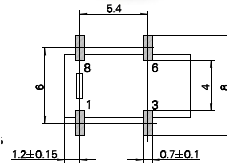
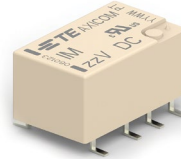

#### Axicom IMC

4G telecom/signal relay/switching relay  
Slim line 10x6mm, low-profile 5.65mm  
Switching power 60W/62.5VA  
Switching voltage 220VDC/250VAC  
Monostable + Bistable  
High dielectric version  
High current version up to 4 A  
Bifurcated contacts

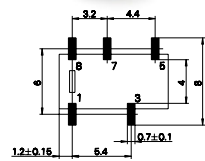
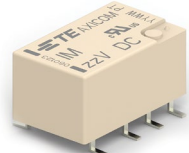

### Footprint

2) see footnote below

### Applications

Telecommunication, access and transmission equipment  
Thermostat controls, fire and security equipment  
Measurement and test equipment, Industrial controls, medical equipment

Telecommunication, access and transmission equipment  
Thermostat controls, fire and security equipment  
Measurement and test equipment, Industrial controls, medical equipment

Telecommunication, access and transmission equipment  
Thermostat controls, fire and security equipment  
Measurement and test equipment, Industrial controls, medical equipment

### Contact Data

Contact arrangement	2 form C, 2 CO Single contact + Bifurcated contacts	1 form A, 1 NO Bifurcated contacts	1 form C, 1 CO Bifurcated contacts
Rated voltage	250VAC/220VDC	250VAC/220VDC	250VAC/220VDC
Rated current	2/5A	2A	2/4A
Switching power / Max. break	60W/62.5VA	60W/62.5VA	60W/62.5VA
Min. recommended contact load	100µV/1µA	100µV/1µA	100µV/1µA
Initial contact resistance	<50mΩ at 10mA/30mV I: < 100mΩ	<100mΩ at 10mA/30mV	<50mΩ at 10mA/ 30mV

### Coil Data

Magnetic system	Polarized	Polarized	Polarized
Rated coil voltage	1.5 to 24VDC	1.5 to 24VDC	1.5 to 24VDC
Rated coil power	50 to 200mW/-/	140mW/-/	140mW/-/
DC coil / bistable 1 coil/2 coils			

### Dielectric Strength

Initial dielectric strength			
between open contacts	750 to 1500Vrms	2500Vrms	1000 to 1600Vrms
between contact and coil	1500 to 1800Vrms	3500Vrms	1800 to 2200Vrms
between adjacent contacts	750 to 1800Vrms		
Initial surge withstand voltage			
between open contacts	1000 to 2500V	3500V	1500 to 2200V
between contact and coil	2000 to 2500V	4900V	2500 to 3000V
between adjacent contacts	1000 to 2500V		
Isolation 100/900MHz	37.0/18.8dB	37.0/18.8dB	37.0/18.8dB
Insertion loss 100/900MHz	0.03/0.33dB	0.03/0.33dB	0.03/0.33dB
Volt. standing wave ratio 100/900MHz	1.06/1.49	1.06/1.49	1.06/1.49
Capacitance			
between open contacts	max. 1pF	max. 1pF	max. 1pF

### Other Data

Ambient temperature (max.)	-40 to +85°C	-40 to +85°C	-40 to +85°C
Category of environmental protection	IP67/RTV	IP67/RTV	IP67/RTV
Terminal type	THT, SMT	THT, SMT	THT, SMT
Dimension (lwh)	10x6x5.65mm	10x6x5.65mm	10x6x5.65mm

### Link to datasheet

[Axicom IM](#)

[Axicom IMB](#)

[Axicom IMC](#)

1) Recommended minimum load indication for contact material: AU and gold plated: 1mA at 6VDC; AgNi0.15 and AgNi90/10: 10mA at 12VDC; AgCdO and AgSnO<sub>2</sub>: 100mA at 12VDC. Please contact technical support for detailed technical data.

2) Footprint images are representative. For a complete selection, refer to the TE data sheet via the link above.

# Signal Relays

## Relays, Contactors & Circuit Breakers

### Key Features

#### Axicom IMD/IME

4G telecom/signal relay/switching relay  
Slim line 10x6mm, low-profile 5.65mm  
Switching power 60W/62.5VA  
Switching voltage 220VDC/250VAC  
Monostable  
Bifurcated contacts

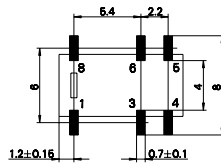
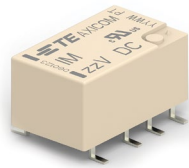

#### Axicom P2 / P2 HIGH DIELECTRIC VERSION

Small Signal relay  
Slim line 15x7.5mm  
Switching current max. 5A  
High dielectric version  
Meets Telcordia Technologies Inc. requirements

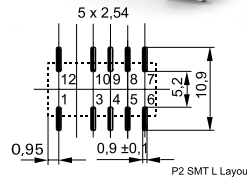
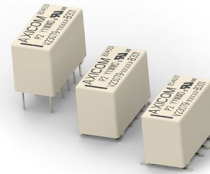

#### Axicom P2 LIGHTING

Small signal relay  
Slim line 15x7.5mm  
Switching current max. 5A  
High dielectric strength 3kV  
VDE certified for LED tubes

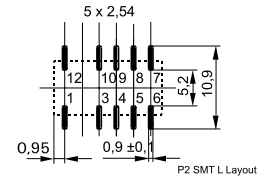
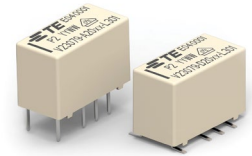

### Footprint

2) see footnote below

### Applications

Telecommunication, access and transmission equipment, fire and security equipment  
Thermostat controls  
Measurement and test equipment, Industrial controls, medical equipment

Security systems, consumer electronics, thermostats  
Home automation systems, communication systems  
Set top boxes, office equipment

LED tubes  
Office equipment  
Security systems, set top boxes

### Contact Data

Contact arrangement	2 form B, 2 NC 2 form A, 2 NO Bifurcated contacts	2 form C, 2 CO Bifurcated contacts	2 form C, 2 CO Bifurcated contacts
Rated voltage	250VAC/220VDC	250VAC/220VDC	250VAC/220VDC
Rated current	2A	2A	2A
Switching power / Max. break	60W/62.5VA	60W/62.5VA	60W/62.5VA
Min. recommended contact load	100µV/1µA	100µV/1µA	100µV/1µA
Initial contact resistance	<50mΩ at 10mA/20mV	<50mΩ at 10mA/20mV	<50mΩ at 10mA/20mV

### Coil Data

Magnetic system	Polarized	Polarized	Polarized
Rated coil voltage	1.5 to 24VDC	2.4 to 24VDC	3 to 12VDC
Rated coil power DC coil / bistable 1 coil/2 coils	140mW/-/-	140mW/70mW/140mW	140mW - 1 coil version

### Dielectric Strength

Initial dielectric strength			
between open contacts	1000Vrms	1000 to 1500Vrms	1500Vrms
between contact and coil	1800Vrms	1500Vrms	3000Vrms
between adjacent contacts	1000Vrms	1000 to 1500Vrms	1500Vrms
Initial surge withstand voltage			
between open contacts	1500V	2000 to 2500Vrms	
between contact and coil	2500V	2500V	6000Vrms
between adjacent contacts	1500V	2500V	
Isolation 100/900MHz	37.0/18.8dB		
Insertion loss 100/900MHz	0.03/0.33dB		
Volt. standing wave ratio 100/900MHz	1.6/1.49		
Capacitance			
between open contacts	max. 1pF		

### Other Data

Ambient temperature (max.)	-40 to +85°C	-40 to +85°C	-40 to +85°C
Category of environmental protection	IP67/RTV	RTIII	RTIII
Terminal type	THT, SMT	THT, SMT	THT, SMT
Dimension (lwh)	10x6x5.65mm	14.5x7.2x10.4mm, stnd 14.5x7.2x9.9mm, ovrmld	14.5x7.2x9.9mm, ovrmld

### Link to datasheet

[Axicom IMD/IME](#)

[Axicom P2 / P2 HIGH DIELECTRIC VERSION](#)

[Axicom P2 LIGHTING](#)

1) Recommended minimum load indication for contact material: 1mA at 6VDC; AgNi015 and AgNi90/10: 10mA at 12VDC; AgCdO and AgSnO<sub>2</sub>: 100mA at 12VDC. Please contact technical support for detailed technical data. 2) Footprint images are representative. For a complete selection, refer to the TE data sheet via the link above.

# Signal Relays

Relays, Contactors & Circuit Breakers

## Key Features

### Axicom FP2

Slim line 14x9mm  
2 form C bifurcated contacts  
High mechanical shock resistance, up to 1500g survival

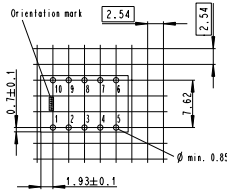
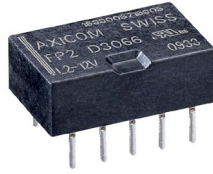

### Axicom D2N V23105

2G telecom/signal relay  
4 coil sensitivities  
3A UL rating

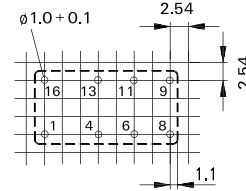

## Footprint

2) see footnote below

## Applications

Communication equipment  
Keyless entry  
Speaker switch, consumer electronics

Communication equipment  
Office equipment  
Measurement and control equipment

## Contact Data

Contact arrangement	1 form C (CO)	2 form C, 2 CO Single Contacts
Rated voltage	220VDC/250VAC	250VAC/220VDC
Rated current	2A	3A
Switching power / Max. break	60W/62.5VA	60W/125VA
Min. recommended contact load	100μV	100μV/10μA
Initial contact resistance	<50mΩ at 10mA	<100mΩ

## Coil Data

Magnetic system	Polarized	Non polarized
Rated coil voltage	2 to 24VDC	3 to 48VDC
Rated coil power DC coil/bistable 1 coil/2 coils	80mW (high sensitive), 140mW	150 to 700mW/-/-

## Dielectric Strength

Initial dielectric strength		
between open contacts	750Vrms	750Vrms
between contact and coil	1000Vrms	1000Vrms
between adjacent contacts	1000Vrms	750Vrms
Initial surge withstand voltage		
between open contacts	1100V	1500V
between contact and coil	1500V	1500V
between adjacent contacts	1500V	1500V
Isolation/Cross talk at 100MHz/900MHz	Cross talk -40.2/-22.3dB	Isolation -39.0/-20.7dB
Insertion loss 100/900MHz	0.03dB/0.25dB	-0.02/-0.27dB
Volt. standing wave ratio 100/900MHz	1.01/1.07	1.04/1.40
Capacitance between open contacts		max. 2pF

## Other Data

Ambient temperature (max.)	-40 to +85°C	-25 to +85°C
Category of environmental protection	IP67/RTIII	IP67/RTIII
Terminal type	THT	THT
Dimension (lwh)	14x9x5mm	20.2x10x11.4mm

## Link to datasheet

[Axicom FP2](#)

[Axicom D2N V23105](#)

1) Recommended minimum load indication for contact material: AU and gold plated: 1mA at 6VDC; AgNi0.15 and AgNi90/10: 10mA at 12VDC; AgCdO and AgSnO<sub>2</sub>: 100mA at 12VDC. Please contact technical support for detailed technical data. 2) Footprint images are representative. For a complete selection, refer to the TE data sheet via the link above.



# Signal Relays

## Relays, Contactors & Circuit Breakers

### Key Features

#### Axicom MT2

2G telecom/signal relay  
5 coil sensitivities  
2A UL rating

#### Axicom P1 V23026

Very high sensitive relay  
Low-profile  
High vibration and shock resistance  
Version: symmetric pin layout  
Temperature range up to 85°C  
1500Vrms across opened contacts

### Footprint

2) see footnote below

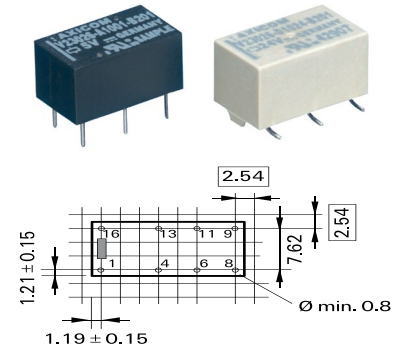
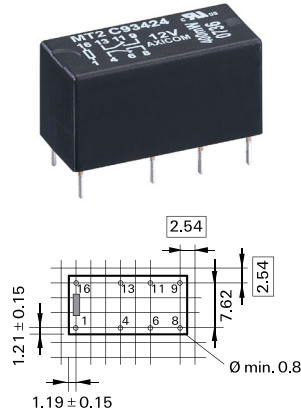

Applications	Communication equipment Linecard application Measurement and control equipment	Automotive equipment CAN bus Imobilizer
<b>Contact Data</b>		
Contact arrangement	2 form C, 2 CO Bifurcated contacts	1 form C, 1 CO Bifurcated contacts
Rated voltage	250VAC/220VDC	150VAC/125VDC
Rated current	2A	1A
Switching power / Max. break	60W/62.5VA	30W/60VA
Min. recommended contact load	100µV/1µA	100µV/1µA
Initial contact resistance	<70mΩ	<50mΩ
<b>Coil Data</b>		
Magnetic system	Non polarized	Polarized
Rated coil voltage	3 to 48VDC	3 to 24VDC
Rated coil power	150 to 550mW/-/-	65 to 130mW/30 to 130mW/70 to 200mW
DC coil/bistable 1 coil/2 coils		
<b>Dielectric Strength</b>		
Initial dielectric strength		
between open contacts	750Vrms	500Vrms
between contact and coil	1000Vrms	1500Vrms
between adjacent contacts	750Vrms	
Initial surge withstand voltage		
between open contacts	1500V	
between contact and coil	1500V	2500V
between adjacent contacts	1500V	
Isolation 100/900MHz	-31.8/-14.2dB	-30.0/-18.0dB
Insertion loss 100/900MHz	-0.02/-0.97dB	-0.12/-1.90dB
Volt. standing wave ratio 100/900MHz	1.03/1.31	1.06/1.75
Capacitance		
between open contacts	max. 2pF	max. 5pF
<b>Other Data</b>		
Ambient temperature (max.)	-55 to +85°C	-40 to +85°C
Category of environmental protection	IP67/RTIII	IP67/RTIII
Terminal type	THT	THT, SMT
Dimension (lwh)	20.2x10x11mm	13x7.6x6.9mm
<b>Link to datasheet</b>	<a href="#">Axicom MT2</a>	<a href="#">Axicom P1 V23026</a>

1) Recommended minimum load indication for contact material: AU and gold plated: 1mA at 6VDC; AgNi0.15 and AgNi90/10: 10mA at 12VDC; AgCdO and AgSnO<sub>2</sub>: 100mA at 12VDC. Please contact technical support for detailed technical data.

2) Footprint images are representative. For a complete selection, refer to the TE data sheet via the link above.

# Signal Relays

Relays, Contactors & Circuit Breakers

## Key Features

### Axicom REED DIP/SIL

Direct driving with TTL signals  
 Ultrasonic cleanable  
 High switching speed  
 Clamping diode  
 Electrostatic shield



### TSC

Designed for thermostat, modem  
 Computer peripherals, video  
 recording and security application  
 Low coil power requirements  
 IC compatibility



### OUAZ/T81

Gold overlay silver palladium alloy  
 contact suitable for low loads  
 High density available on PCB due to  
 small size  
 2.54mm terminal pitch same as IC  
 socket terminal pitch  
 Sensitive and standard coils



## Footprint

2) see footnote below

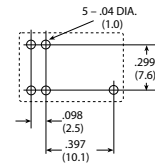
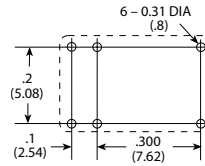
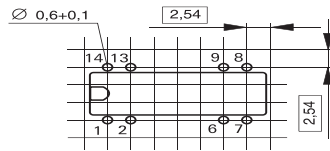

Applications	Incircuit tester Measuring and control systems Alarm and security equipment	Telecommunications Office machine	Telecommunications Logic and process control Vending machines
<b>Contact Data</b>			
Contact arrangement	1 form A, 1 NO 2 form A, 2 NO 1 form C, 1 CO Reed contacts	1 form C, 1 CO	1 form C, 1 CO 1 form A, 1 NO
Rated voltage	175 to 200VAC/VDC	120VAC, 30VDC	120VAC/24VDC
Rated current	0.25 to 0.5A	1A	1A
Switching power / Max. break	3 to 10W	120VA, 24W	120VA, 30W
Min. recommended contact load	10μV/1μA	1mA at 1VDC	1mA at 1VDC
Initial contact resistance	<150mΩ	50mΩ at 100mA, 6VDC	
<b>Coil Data</b>			
Magnetic system	Non polarized	DC, sensitive	DC, sensitive
Rated coil voltage	5 to 24VDC	3 to 24VDC	5 to 24VDC
Rated coil power	50 to 300mW/-/- DC coil/bistable 1 coil/2 coils	150, 300mW	200, 450mW
<b>Dielectric Strength</b>			
Initial dielectric strength			
between open contacts	140 to 175Vrms	400Vrms	500Vrms
between contact and coil	500vdc	1000Vrms	1000Vrms
between adjacent contacts	500vdc		
Initial surge withstand voltage			
between open contacts			
between contact and coil		1500Vp (10/160μs)	1500Vp (10/160μs)
between adjacent contacts			
Isolation 100/900MHz			
Insertion loss 100/900MHz			
Volt. standing wave ratio 100/900MHz			
Capacitance			
between open contacts	max. 1pF		
<b>Other Data</b>			
Ambient temperature (max.)	-20 to +70°C	40 to +80°C	-40 to +60°C (standard)
Category of environmental protection	IP67/RTIII	RTIII/IP67	RTII, RTIII
Terminal type	THT	THT	THT
Dimension (lwh)	19.3x5.7x7.5mm/19.8x5.1x8mm	12.5x7.5x10mm	15.4x10.4x11.2mm
<b>Link to datasheet</b>	<a href="#">Axicom REED DIP/SIL</a>	<a href="#">TSC</a>	<a href="#">OUAZ/T81</a>

1) Recommended minimum load indication for contact material: AU and gold plated: 1mA at 6VDC; AgNi0.15 and AgNi90/10: 10mA at 12VDC; AgCdO and AgSnO<sub>2</sub>: 100mA at 12VDC. Please contact technical support for detailed technical data. 2) Footprint images are representative. For a complete selection, refer to the TE data sheet via the link above.



# High Frequency Relays

## Relays, Contactors & Circuit Breakers

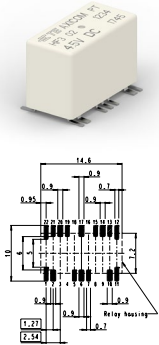
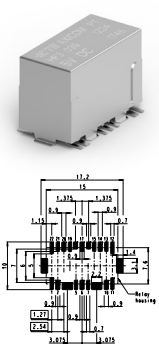
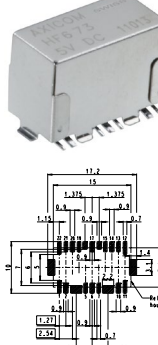
	<b>Axicom HF3</b>	<b>Axicom HF3S</b>	<b>Axicom HF6</b>
<b>Key Features</b>	High performance RF relay/switch for up to 3GHz Low power consumption $\leq 70/140$ mW 50 and 75 $\Omega$ version Very small design	High performance RF relay/switch for up to 3GHz Low power consumption $\leq 70/140$ mW 50 and 75 $\Omega$ version RF power 100W at 2GHz Very small design	High performance RF relay/switch for up to 6GHz Low power consumption $\leq 70/140$ mW 50 $\Omega$ version Very small design
<b>Footprint</b> 2) see footnote below			
<b>Applications</b>	Cable modems and linecards/CATV Measurement and test equipment ATE Satellite/audio/video tuners	Cable modems and linecards/CATV Measurement and test equipment ATE Satellite/audio/video tuners	Measurement and test equipment ATE Wireless base stations and antennas Wireless infrastructure
<b>Contact Data</b>	1 form C, 1 CO Bridge contacts Rated voltage 250VAC/220VDC Rated current 2A Switching power / Max. break 60W/62.5VA/50W (2.5GHz) Min. recommended contact load 100 $\mu$ V/1 $\mu$ A Initial contact resistance <100m $\Omega$	1 form C, 1 CO Bridge contacts Rated voltage 250VAC/220VDC Rated current 2A Switching power / Max. break 60W/62.5VA/50W (2.5GHz) Min. recommended contact load 100 $\mu$ V/1 $\mu$ A Initial contact resistance <100m $\Omega$	1 form C, 1 CO Bridge contacts Rated voltage 250VAC/220VDC Rated current 2A Switching power / Max. break 60W/62.5VA/50W (2.5GHz) Min. recommended contact load 100 $\mu$ V/1 $\mu$ A Initial contact resistance <100m $\Omega$
<b>Coil Data</b>	Magnetic system Polarized Rated coil voltage 3 to 24VDC Rated coil power 140mW/70mW/140mW DC coil/bistable 1 coil/2 coils	Magnetic system Polarized Rated coil voltage 3 to 24VDC Rated coil power 140mW/70mW/140mW	Magnetic system Polarized Rated coil voltage 3 to 24VDC Rated coil power 140mW/70mW/140mW
<b>Dielectric Strength</b>	Initial dielectric strength between open contacts 600Vrms between contact and coil 1000Vrms between adjacent contacts 1000Vrms Initial surge withstand voltage between open contacts 1000Vp between contact and coil 1500Vp between adjacent contacts 1500Vp Capacitance between open contacts max. 1pF	Initial dielectric strength between open contacts 600Vrms between contact and coil 1000Vrms between adjacent contacts 1000Vrms Initial surge withstand voltage between open contacts 1000Vp between contact and coil 1500Vp between adjacent contacts 1500Vp Capacitance between open contacts max. 1pF	Initial dielectric strength between open contacts 600Vrms between contact and coil 1000Vrms between adjacent contacts 1000Vrms Initial surge withstand voltage between open contacts 1000Vp between contact and coil 1500Vp between adjacent contacts 1500Vp Capacitance between open contacts max. 1pF
<b>RF Data</b>	0.1/0.9/3GHz Isolation -80/-72/-DB45 Insertion loss -0.03/0.12/-0.35dB Voltage standing wave ratio (VSWR) 1.05/1.15/1.20	0.1/0.9/3GHz Isolation -95/-80/-55dB Insertion loss -0.03/-0.12/-0.30dB Voltage standing wave ratio (VSWR) 1.05/1.10/1.25	0.9/3/6GHz Isolation -80/-60/-30dB Insertion loss -0.05/-0.15/-0.80dB Voltage standing wave ratio (VSWR) 1.05/1.10/1.40
<b>Other Data</b>	Ambient temperature (max.) -55 to +85°C Category of environmental protection IP67/RTIII Terminal type SMT Dimension (lwh) 14.6x7.2x10mm	Ambient temperature (max.) -55 to +85°C Category of environmental protection IP67/RTIII Terminal type SMT Dimension (lwh) 15x7.6x10.6mm	Ambient temperature (max.) -55 to +85°C Category of environmental protection IP67/RTIII Terminal type SMT Dimension (lwh) 15x7.6x10.6mm
<b>Link to datasheet</b>	<a href="#">Axicom HF3</a>	<a href="#">Axicom HF3S</a>	<a href="#">Axicom HF6</a>

1) Recommended minimum load indication for contact material: AU and gold plated: 1mA at 6VDC; AgNi0.15 and AgNi90/10: 10mA at 12VDC; AgCdO and AgSnO<sub>2</sub>: 100mA at 12VDC. Please contact technical support for detailed technical data. 2) Footprint images are representative. For a complete selection, refer to the TE data sheet via the link above.

# Solid State Relays

Relays, Contactors & Circuit Breakers

## Key Features

### Potter & Brumfield SSR

Standard "hockey puck" package  
Inverse parallel SCR output  
240VAC & 480VAC output types  
Zero voltage and random voltage turn-on versions  
4,000Vrms optical isolation  
Cover design with anti-rotation barriers  
1 Form A (SPST-NO)



PCB mount not applicable.  
Visit [TE.com](https://www.te.com) for more information

### Potter & Brumfield SSRD

Two independent AC output solid state relays  
Standard "hockey puck" package  
Inverse parallel SCR output  
4000Vrms optical isolation  
Quick connect style termination  
2 Form A (2 SPST-NO)



PCB mount not applicable.  
Visit [TE.com](https://www.te.com) for more information

### Potter & Brumfield SSRT

Standard "hockey puck" package  
TRIAC Output  
4,000Vrms optical isolation  
Cover design with anti-rotation barriers  
1 Form A (SPST-NO)



PCB mount not applicable.  
Visit [TE.com](https://www.te.com) for more information

## Typical Applications

Industrial machinery  
HVAC  
Building controls

Industrial machinery  
HVAC  
Building controls

Industrial machinery  
HVAC  
Building controls

## Output Data

Load Voltage	24 - 280VAC/48 - 660VAC	24 - 280VAC	24 - 280VAC
Repetitive Blocking Voltage	600VAC/1200VAC	600VAC	600VAC
Load Current Range	25A/50A/125A	25A/40A	10A/25A
Leakage Current (Off-State)	5mA	5mA	5mA
On-State Voltage Drop (Max.)	1.8V	1.8V	1.6V
Load Power Factor Rating	0.5 - 1.0	0.5 - 1.0	0.5 - 1.0
Thermal Resistance, Junction to Case (ROJ-C) (Max.)	2.35/0.55/0.35	2.35/0.86	2.4/1.7

## Input Data (AC/DC)

Control Voltage Range VIN	90 - 280VAC/3 - 32VDC	4 - 15VDC	90 - 280VAC/3 - 32VDC
Must Operate Voltage VIN(OP) (Min.)	90VAC/3VDC	4VDC	90VAC/3VDC
Must release Voltage VIN(REL) (Min.)	10VAC/1VDC	1VDC	10VAC/1VDC
Input Current	2 - 26mA / 3 - 30mA	15mA @ 8VDC	25mA/20mA

## Dielectric Strength

Isolation:	4000Vrms	4000Vrms	4000Vrms
------------	----------	----------	----------

## Other Data

Dimensions	46.5x57.8x43.4mm	44.5x57.8x30.15mm	45x57.5x36.5mm
Operating Temperature	-30 to +80°C	-30 to +80°C	-30 to +80°C
Mounting	Panel	Panel	Panel
UL File No	E29244	E29244	E29244

## Link to datasheet

[Potter & Brumfield SSR](#)

[Potter & Brumfield SSRD](#)

[Potter & Brumfield SSRT](#)

1) Recommended minimum load indication for contact material: AU and gold plated: 1mA at 6VDC; AgNi0.15 and AgNi90/10: 10mA at 12VDC; AgCdO and AgSnO<sub>2</sub>: 100mA at 12VDC. Please contact technical support for detailed technical data.

# Solid State Relays

## Relays, Contactors & Circuit Breakers

### Key Features

#### Potter & Brumfield SSRDC

Standard "hockey puck" package  
200VDC FET output  
12A, 25A and 40A load current options  
1500VDC optical isolation  
Cover design with anti-rotation barriers  
1 Form A (SPST-NO)



PCB mount not applicable.  
Visit [TE.com](https://www.te.com) for more information

#### Potter & Brumfield SSRK

10-30A DIN mount Solid State Relay with integrated heat sink  
Narrow 22.5mm design  
Inverse parallel SCR output  
240VAC & 600VAC output types  
4,000Vrms optical isolation  
1 Form A (SPST-NO)



PCB mount not applicable.  
Visit [TE.com](https://www.te.com) for more information

#### Potter & Brumfield SSRM

45A-65A DIN mount Solid State Relay with integrated heat sink  
44.5mm design  
Inverse parallel SCR output  
600VAC output type  
4,000Vrms optical isolation  
1 Form A (SPST-NO)



PCB mount not applicable.  
Visit [TE.com](https://www.te.com) for more information

### Typical Applications

Material handling  
Trains  
Construction equipment

Industrial machinery  
HVAC  
Building controls

Industrial machinery  
HVAC  
Building controls

### Output Data

Load Voltage	200VDC	24 - 280VAC/48 - 660VAC	48 - 660VAC
Repetitive Blocking Voltage	NA	600VAC/1200VAC	1200VAC
Load Current Range	10 A/25 A/40 A	10A/20A/30A	45A/55A/65A
Leakage Current (Off-State)	12mA	5mA	1mA
On-State Voltage Drop (Max.)	2.83VDC	1.8V/1.6V	1.7V
Load Power Factor Rating	NA	0.5 - 1.0	0.5 - 1.0
Thermal Resistance, Junction to Case (R <sub>θJ-C</sub> ) (Max.)	0.7/0.7/0.5	-	-

### Input Data (AC/DC)

Control Voltage Range VIN	3 - 32VDC	90 - 280VAC/3 - 32VDC	90 - 140VAC/4 - 32VDC
Must Operate Voltage VIN(OP) (Min.)	3.5VDC	90VAC/3VDC	90VAC/3VDC
Must release Voltage VIN(REL) (Min.)	1VDC	10VAC/1VDC	10VAC/1VDC
Input Current	30mA	7.5mA - 16mA/18 - 30mA	15mA/14 - 30mA

### Dielectric Strength

Isolation:	1500VDC	4000Vrms	4000Vrms
------------	---------	----------	----------

### Other Data

Dimensions	45x57.8x43.4mm	22.5x82.3x111.5mm	22.5x76.2x109.2mm
Operating Temperature	-30 to +80°C	-30 to +80°C	-40 to +80°C
Mounting	Panel	Din Rail	Din Rail
UL File No	E29244	E29244	E29244

### Link to datasheet

[Potter & Brumfield SSRDC](#)

[Potter & Brumfield SSRK](#)

[Potter & Brumfield SSRM](#)

1) Recommended minimum load indication for contact material: AU and gold plated; 1mA at 6VDC; AgNi0.15 and AgNi90/10; 10mA at 12VDC; AgCdO and AgSnO<sub>2</sub>; 100mA at 12VDC. Please contact technical support for detailed technical data.

# Solid State Relays

Relays, Contactors & Circuit Breakers

## Key Features

## Footprint

2) see footnote below

### Potter & Brumfield SSRA

2A Miniature, SIP Solid State Relay  
Inverse parallel SCR output  
2500Vrms optical isolation  
240VAC output  
1 Form A (SPST-NO)

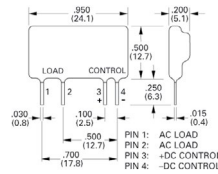

### Potter & Brumfield SSRC

5A SIP Solid State Relay  
Inverse parallel SCR output  
4000Vrms optical isolation  
1 Form A (SPST-NO)

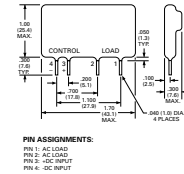

Typical Applications	Industrial machinery HVAC Building controls	Industrial machinery HVAC Building controls
<b>Output Data</b>		
Load Voltage	12 - 280VAC	12 - 280VAC/48 - 660VAC
Repetitive Blocking Voltage	600VAC	600VAC/1200VAC
Load Current Range	2A	5A
Leakage Current (Off-State)	0.1mA	0.1mA
On-State Voltage Drop (Max.)	1.5V	1.4V
Load Power Factor Rating	0.5 - 1.0	0.5 - 1.0
Thermal Resistance, Junction to Case (ROJ-C) (Max.)	-	-
<b>Input Data (AC/DC)</b>		
Control Voltage Range VIN	4-10VDC	3 - 15VDC
Must Operate Voltage VIN(OP) (Min.)	4VDC	4VDC
Must release Voltage VIN(REL) (Min.)	1VDC	1VDC
Input Current	15mA	15mA
<b>Dielectric Strength</b>		
Isolation:	2500Vrms	4000Vrms
<b>Other Data</b>		
Dimensions	24.1x5.1x12.7mm	43.1x7.6x25.4mm
Operating Temperature	-30 to + 80°C	-30 to + 80°C
Mounting	PCB	PCB
UL File No	E29244	E29244
<b>Link to datasheet</b>	<a href="#">Potter &amp; Brumfield SSRA</a>	<a href="#">Potter &amp; Brumfield SSRC</a>

1) Recommended minimum load indication for contact material: AU and gold plated: 1mA at 6VDC; AgNi0.15 and AgNi90/10: 10mA at 12VDC; AgCdO and AgSnO<sub>2</sub>: 100mA at 12VDC. Please contact technical support for detailed technical data.

2) Footprint images are representative. For a complete selection, refer to the TE data sheet via the link above.



# Solid State Relays

Relays, Contactors & Circuit Breakers

## Key Features

### Potter & Brumfield OACM

Slim Solid State AC Output Module  
Color coded by function - black  
4000Vrms optical isolation  
Compatible with 2IO series mounting boards  
1 Form A (SPST-NO)

### Potter & Brumfield IDCM

Slim Solid State DC Input Module  
Color coded by function - white  
4000Vrms optical isolation  
Compatible with 2IO series mounting boards  
1 Form A (SPST-NO)

### Potter & Brumfield ODCM

Slim Solid State AC Output Module  
Color coded by function - red  
4000Vrms optical isolation  
Compatible with 2IO series mounting boards  
1 Form A (SPST-NO)

## Footprint

2) see footnote below

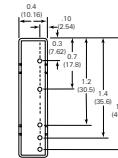
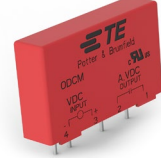
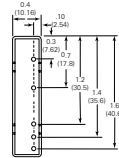
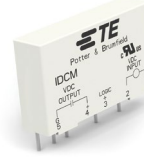
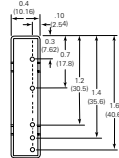

## Typical Applications

Industrial machinery  
HVAC  
Building controls

Industrial machinery  
HVAC  
Building controls

Industrial machinery  
HVAC  
Building controls

## Output Data

Load Voltage	24 - 280VAC	30VDC	60VDC
Repetitive Blocking Voltage	600VAC	-	-
Load Current Range	3A/5A	50mA	3A
Leakage Current (Off-State)	5mA	10uA	0.5mA
On-State Voltage Drop (Max.)	1.6VAC	0.2VDC	1.5VDC
Load Power Factor Rating	-	-	-
Thermal Resistance, Junction to Case (R <sub>θJ-C</sub> ) (Max.)	-	-	-

## Input Data (AC/DC)

Control Voltage Range VIN	3 - 8VDC / 3 - 15VDC	3 - 32VDC/10 - 60VDC	5VDC/15VDC/24VDC
Must Operate Voltage VIN(OP) (Min.)	3VDC	3VDC/10VDC	3VDC/9VDC/18VDC
Must release Voltage VIN(REL) (Min.)	1VDC	1VDC/1VDC	1VDC
Input Current	8mA	10mA	20mA

## Dielectric Strength

Isolation:	4000Vrms	4000Vrms	4000Vrms
------------	----------	----------	----------

## Other Data

Dimensions	43.5x10.3x25.5mm	43.5x10.3x25.5mm	43.5x10.3x25.5mm
Operating Temperature	-30 to 100°C	-30 to 100°C	-30 to 100°C
Mounting	PCB	PCB	PCB
UL File No	E29244	E29244	E29244

## Link to datasheet

[Potter & Brumfield OACM](#)

[Potter & Brumfield IDCM](#)

[Potter & Brumfield ODCM](#)

1) Recommended minimum load indication for contact material: AU and gold plated: 1mA at 6VDC; AgNi0.15 and AgNi90/10: 10mA at 12VDC; AgCdO and AgSnO<sub>2</sub>: 100mA at 12VDC. Please contact technical support for detailed technical data. 2) Footprint images are representative. For a complete selection, refer to the TE data sheet via the link above.



# Circuit Breakers

## Relays, Contactors & Circuit Breakers

### Key Features

#### Potter & Brumfield W28

Thermal Overload / Trip Free Operation  
 Replaces slow blow glass cartridge fuse and holder  
 Button provides visible trip indication  
 Push-to-reset  
 Snap-in mounting  
 UL 1077, CSA, VDE, CCC (16A/20A not VDE)



PCB mount not applicable.  
 Visit [TE.com](https://www.te.com) for more information

#### Potter & Brumfield W23/W31

Thermal Overload / Trip Free Operation  
 Toggle or Push/Pull Actuation  
 Cannot be reset against overload  
 On/Off switching option  
 UL 1077, CSA



PCB mount not applicable.  
 Visit [TE.com](https://www.te.com) for more information

### Typical Applications

HVAC (Transformers), General Aviation, Medical, Marine Power Supplies, Lighting, Surge Protection Audio, Pool and Spa, Appliances, Industrial Controls

Generators, General Aviation, Medical, Marine Power Supplies, Lighting, Surge Protection Audio, Pool and Spa, Appliances, Industrial Controls

### Operational Data

Type	Thermal	Thermal
Number of Poles	1	1
Circuit function	Series trip	Series trip
Ambient temperature (max.)	-20 to +60 °C	-20 to +65°C
Terminal type	Standard quick connect .250in x .032in	#8-32 screw
Mounting	Snap-in	Thru-hole 3/8"-24 threaded bushing
Manual operation Actuator	Push-to-reset	Push/pull W23 and toggle W31
Dimension L*W*H	39.0 x 15.9 x 13.7mm	40.6x17.5x35.2mm

### Electrical Data

Dielectric strength	1500Vrms	1500Vrms
Insulation Resistance		
Max Operating Voltages	32VDC 250VAC, 50/60Hz	50VDC 240VAC to (400Hz)
Rated current	0.5A to 20A	1A to 50A
Interrupt capacity	1,000 amps at 250VAC, 50/60 Hz. and 32VDC in accordance with UL standard 1077.	<b>With 4X Max. Series Fuse Protection</b> 0.5-50 amp models – 1000 amps at 240VAC. 30-50 amp models – 1000 amps at 50VDC. <b>Without 4X Max. Series Fuse Protection</b> 0.5-25 amp models – 2000 amps at 50VDC. 10-20 amp models – 2000 amps at 120VAC Continuously carry 100% of rating, may trip between 101% and 134% of rating at 25°C. Must trip at 135% in one hour.
Calibration	Will continuously carry 100% of rating. 3-20 amp models - may trip between 101% and 134%, but must trip at 135% of rating within one hour at +25°C. 0.25-2 amp models - may trip between 101% and 174%, but must trip at 175% of rating within one hour at +25°C.	
Resettable Overload Capacity	Six times rated current for 0.25 through 2 amp models. Ten times rated current for 3 through 20 amp models.	Ten times rated current.
Reset Time	180 seconds max. for 0.25 through 2 amp models. 5 to 30 seconds for 3 through 20 amp models.	

### Accessories

Protective boot, push-on lockwasher

Hex nut, lockwasher, knurl nut

### Link to datasheet

[Potter & Brumfield W28](#)

[Potter & Brumfield W23/W31](#)

1) Recommended minimum load indication for contact material: AU and gold plated: 1mA at 6VDC; AgNi015 and AgNi90/10: 10mA at 12VDC; AgCdO and AgSnO<sub>2</sub>: 100mA at 12VDC. Please contact technical support for detailed technical data. 2) Footprint images are representative. For a complete selection, refer to the TE data sheet via the link above.

# Circuit Breakers

Relays, Contactors & Circuit Breakers

## Key Features

### Potter & Brumfield W33

Thermal overload/trip free Operation  
Optional indicator lamp  
Optional auxiliary switch  
Combines on/off switching and circuit protection in a single unit  
UL 1077, CSA



PCB mount not applicable.  
Visit [TE.com](https://www.te.com) for more information

### Potter & Brumfield W51

Thermal overload/trip free operation  
Rocker actuated with switch overload sensing  
Optional indicator lamp  
Combines power switching and circuit protection in a single unit  
Compact design  
PCB termination options  
UL1077, cUL, VDE, CCC



PCB mount not applicable.  
Visit [TE.com](https://www.te.com) for more information

### Potter & Brumfield W54

Thermal overload/trip free operation  
Push to reset  
Visual trip indication  
Multiple termination options  
UL 1077, UL 1500, cUL, VDE, CCC, CSA. (>30A not UL1500 or CSA) (>20A not VDE)



PCB mount not applicable.  
Visit [TE.com](https://www.te.com) for more information

## Typical applications

Generators, General Aviation, Medical, Marine  
Power Supplies, Lighting, Surge Protection  
Audio, pool and spa, appliances, Industrial controls

Generators, General Aviation, Medical, Marine  
Power Supplies, Lighting, Surge Protection  
Audio, pool and spa, appliances, Industrial controls

Generators, general aviation, medical, marine  
Power supplies, lighting, surge protection  
Audio, pool and spa, appliances, Industrial controls

## Operational Data

Type	Thermal	Thermal	Thermal
Number of Poles	1-2	1	1
Circuit function	Series trip both poles; series trip 1 pole/switch only 1 pole; switch only 2 poles	Series trip	Series trip
Ambient temperature (max.)	-20 to +65 °C	0°C to + 60 °C for 10-20A models 0°C to + 50 °C for 5-8A models	0 to 60 °C
Terminal type	Standard quick connect 250in x .032in and solder option	Standard quick connect 250in x .032in/solder option/PCB	Standard quick connect 250in x .032in and #8-32 screw 3/8"-24, M11-1.0, M12-1.0 threaded bushing
Mounting	Snap-in	Snap-in, PCB	
Manual operation Actuator	Rocker	Rocker	Push-to-reset
Dimension L*W*H	43.8 x 24.9 x 48.0mm	21.8 x 15.2 x 32.0mm	31.0 x 14.6 x 35.0mm (W54) 22.6 x 14.6 x 29.2mm (W57)

## Electrical Data

Dielectric strength	2000Vrms	1500VAC	1500VAC
Insulation Resistance		100M Ω	100MΩ
Max Operating Voltages	50VDC 250VAC	50VDC 125/250VAC (model dependent)	50VDC 250VAC
Rated current	2A to 20A	5A to 20A	5A to 40A
Interrupt capacity	1000A at 50VDC, 250VAC/60Hz and 125/250VAC 400Hz; 1500A at 25/250VAC/60Hz	1,000 amps in accordance with UL standard 1077	1,000 amps in accordance with UL standard 1077
Calibration	Will continuously carry 100% of rating. May trip between 101% and 134%, but must trip at 135% of rating within one hour at +25°C 150% for 5-8A models	Will continuously carry 100% of rating. May trip between 101% and 134%, but must trip at 135% of rating within one hour at +25°C. 150% for 5-8A models	Will continuously carry 100% of rating. May trip between 101% and 134%, but must trip at 135% of rating within one hour at +25°C
Resettable OverloadCapacity	Ten times rated current	Ten times rated current. Switch Endurance Cycling: Typically 6,000 operations at 100% of rating	Ten times rated current.
Reset Time		60 Seconds	60 Seconds

## Accessories

Protective boot, knurl nut, hex nut, lockwasher, nameplate

## Link to datasheet

[Potter & Brumfield W33](#)

[Potter & Brumfield W51](#)

[Potter & Brumfield W54](#)

1) Recommended minimum load indication for contact material: AU and gold plated: 1mA at 6VDC; AgNi0.15 and AgNi90/10: 10mA at 12VDC; AgCdO and AgSnO<sub>2</sub>: 100mA at 12VDC. Please contact technical support for detailed technical data.

# Circuit Breakers

## Relays, Contactors & Circuit Breakers

### Key Features

#### Potter & Brumfield W57

Thermal overload/trip free operation  
Push to reset  
Compact design  
Cannot be manually tripped  
PCB termination options  
UL 1077, UL 1500, cUL, VDE, CCC.  
(3A,4A,20A no VDE)



PCB mount not applicable.  
Visit [TE.com](https://www.te.com) for more information

#### Potter & Brumfield W58

Thermal overload/trip free operation  
Push to reset  
Cannot be manually tripped  
Visual trip indication  
UL 1077, UL 1500, CSA. (30A not UL or CSA)



PCB mount not applicable.  
Visit [TE.com](https://www.te.com) for more information

#### Potter & Brumfield W6/W9

Magnetic hydraulic actuation/trip-free operation  
Several delay curve options  
Fungus and moisture resistant  
UL 1077, UL 1500, CSA, VDE



PCB mount not applicable.  
Visit [TE.com](https://www.te.com) for more information

### Applications

Generators, general aviation, medical, marine  
Power supplies, lighting, surge protection  
Audio, pool and spa, appliances, Industrial controls

Generators, general aviation, medical, marine  
Power supplies, lighting, surge protection  
Audio, pool and spa, appliances, Industrial controls

HVAC (transformers), general aviation, medical, marine  
Power supplies, lighting, surge protection  
Audio, pool and spa, appliances, Industrial controls

### Operational Data

Type	Thermal	Thermal	Magnetic/hydraulic
Number of Poles	1	1	1-4
Circuit function	Series trip	Series trip	Series trip
Ambient temperature (max.)	0 to 60°C	-25 to 65°C	-40 to +85 °C
Terminal type	Standard quick connect .250in x .032in and #8-32 screw and PCB option	Standard quick connect .250in x .032in and #8-32 screw	W6-Standard Quick Connect .250in x .032in and #8-32 or #10/32 screw. W9- #10/32 stud terminations 6-32, M3 tapped holes
Mounting	3/8"-24, M11-1.0, M12-1.0 threaded bushing	7/16"-28, 15/32"-32, 3/8"-24 threaded bushing"	
Manual operation Actuator	Push-to-reset	Push-to-reset	Toggle
Dimension L*W*H	31.0 x 14.6 x 35.0mm (W54) 22.6 x 14.6 x 29.2mm (W57)	34.9 x 16.8 x 34.9mm	41.7 x 19.0 x 50.8mm (W6 per pole) 46.9 x 19.0 x 63.5mm (W9 per pole)

### Electrical Data

Dielectric strength	1500VAC	1500Vrms	50/60 Hz, 1500V: DC, 1100V
Insulation Resistance			100 megohms at 500VDC
Max Operating Voltages	50VDC, 250VAC 50/60 Hz	50VDC, 250VAC	65VDC, 277VAC, 480VAC - 3Ø wye
Rated current	3A to 20A	0.5A to 30A	0.20A to 50A
Interrupt capacity	1000 amps in accordance with UL standard 1077	2000 amps at 50VDC (0.5 - 30 amp models) 1000 amps at 250VAC (0.5 - 30amp models). Note: 30 amp model not UL or CSA	up to 5000A with UL 1077, CSA, VDE. Up to 3000A for UL 1500
Calibration	Will continuously carry 100% of rating. May trip between 101% and 134%, but must trip at 135% of rating within one hour at +25°C	Breaker will continuously carry 100% of rated load. It may trip between 101% and 145% of rated load, but must trip at 145% at 25°C	Breakers will hold 100% rated current. May trip between 101% and 124% rated load (134% for AC/DC units) Must trip at 125% rated load (135% for AC/DC units)
Resettable Overload Capacity	Ten times rated current	Ten times rated current	Ten times rated current
Reset Time	60 Seconds		60 Seconds

### Accessories

Protective boot, knurl nut, hex nut, lockwasher, nameplate

Protective boot, knurl nut, hex nut, lockwasher

Toggle guard (W6 only)

### Link to datasheet

[Potter & Brumfield W57](#)

[Potter & Brumfield W58](#)

[Potter & Brumfield W6/W9](#)

1) Recommended minimum load indication for contact material: AU and gold plated: 1mA at 6VDC; AgNi0.15 and AgNi90/10: 10mA at 12VDC; AgCdO and AgSnO<sub>2</sub>: 100mA at 12VDC. Please contact technical support for detailed technical data.

# Transformers

Relays, Contactors & Circuit Breakers

## Key Features

### 4000 SERIES WIRE LEAD CLASS II CONTROL TRANSFORMERS

5VA to 75VA  
 UL 5085-3, formerly UL 1585  
 Inherently/non-inherently energy limited  
 Wire lead terminations  
 Custom specification/design available

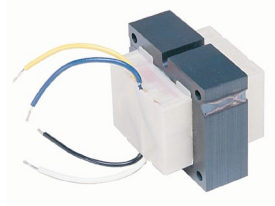

Visit [TE.com](http://TE.com) for more information

### 4000 SERIES QUICK CONNECT CLASS II CONTROL TRANSFORMERS

5VA to 75VA  
 UL 5085-3, formerly UL 1585  
 Inherently/non-inherently energy limited  
 Quick connect terminals  
 Custom specification/design available

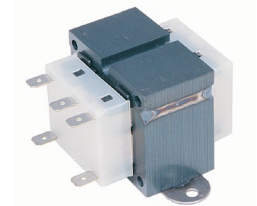

Visit [TE.com](http://TE.com) for more information

## Typical Applications

HVAC  
 Industrial and residential  
 Motor control

HVAC  
 Industrial and residential  
 Motor control

## Specifications

Primary Voltage- AC	120, 208, 240, 277, 380, 415, 480, 575	120, 208, 240, 277, 380, 415, 480, 575
Secondary Voltage- DC	12 or 24	12 or 24
Insulation Class	UL Class B (130°C)	UL Class B (130°C)
Wire Size	Standard 18 AWG stranded, 12in	N/A
QC size	N/A	standard .250in x .032in
Terminations	Same side - opposite side	Type BB Same side Type AB Opposite side Type AE Laydown
Frequency	50/60 Hz	50/60 Hz
Mounting Options	Type K Foot Mount Type G Panel Mount Plate Mount	Type K Foot Mount Type G Panel Mount Plate Mount

## Other Data

Secondary Fusing Requirement	60VA-75VA non-inherently energy limited	Internal fuse or integral circuit breaker 75VA standard models come with integral circuit breaker
Shielding	Internal fuse or integral circuit breaker	
Dielectric Strength	75VA standard models come with integral circuit breaker	

## Link to datasheet

[4000 SERIES WIRE LEAD CLASS II CONTROL TRANSFORMERS](#)

[4000 SERIES QUICK CONNECT CLASS II CONTROL TRANSFORMERS](#)

1) Recommended minimum load indication for contact material: AU and gold plated: 1mA at 6VDC; AgNi0.15 and AgNi90/10: 10mA at 12VDC; AgCdO and AgSnO<sub>2</sub>: 100mA at 12VDC. Please contact technical support for detailed technical data.

# Transformers

Relays, Contactors & Circuit Breakers

## Key Features

### 4700 SERIES GENERAL PURPOSE POWER TRANSFORMERS

60VA to 150VA  
 UL 5085-1,-2 formerly UL 50  
 Non-fused  
 Wire leads or quick connects  
 Custom specification/design available

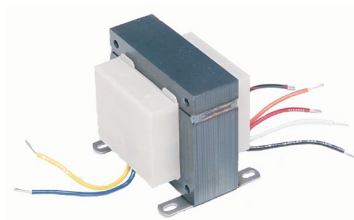

Visit [TE.com](https://www.te.com) for more information

### 4900 SERIES PRINTED CIRCUIT MOUNT POWER TRANSFORMERS

1.1VA to 36VA  
 UL 5085-1,-2 formerly UL 506  
 Drop in replacement  
 Split bobbin design  
 Signal or dual primary voltage  
 Custom specification/design available



Visit [TE.com](https://www.te.com) for more information

Applications	HVAC Industrial Motor control	Industrial controls, garage door openers small power supplies, control boards lighting/monitoring controls, vending machines
<b>Specifications</b>		
Primary Voltage- AC	120, 208, 240, 230, 277, 460, 480, 575	Single 115VAC, 6-pin Dual 115/230VAC, 8-pin
Secondary Voltage- DC	24	Series 10-120VCT Parallel 6-60VAC
Insulation Class	UL Class B (130°C)	UL Class B (130°C)
Wire Size	Standard 18 AWG stranded, 12in	N/A
QC size	Standard .250in x .032in	N/A
Terminations	Type BB same side Type AB opposite side	PCB through hole design
Frequency	50/60 Hz	50/60 Hz
Mounting Options	Type K foot mount	PCB through hole design
<b>Other Data</b>		
Secondary Fusing Requirement		
Shielding		Electrostatic shielding not required due to split bobbin
Dielectric Strength		1500Vrms
Link to datasheet	<a href="#">4700 SERIES GENERAL PURPOSE POWER TRANSFORMERS</a>	<a href="#">4900 SERIES PRINTED CIRCUIT MOUNT POWER TRANSFORMERS</a>

1) Recommended minimum load indication for contact material: AU and gold plated: 1mA at 6VDC; AgNi0.15 and AgNi90/10: 10mA at 12VDC; AgCdO and AgSnO<sub>2</sub>: 100mA at 12VDC. Please contact technical support for detailed technical data.

---

**te.com**

© 2019 TE Connectivity. All Rights Reserved.

Axicom, Potter & Brumfield, SCHRACK, TE, TE Connectivity, and TE Connectivity (logo) are trademarks. All other logos, products and/or company names referred to herein might be trademarks of their respective owners.

While TE has made every reasonable effort to ensure the accuracy of the information in this brochure, TE does not guarantee that it is error-free, nor does TE make any other representation, warranty or guarantee that the information is accurate, correct, reliable or current. TE reserves the right to make any adjustments to the information contained herein at any time without notice. TE expressly disclaims all implied warranties regarding the information contained herein, including, but not limited to, any implied warranties of merchantability or fitness for a particular purpose. The dimensions in this catalog are for reference purposes only and are subject to change without notice. Specifications are subject to change without notice. Consult TE for the latest dimensions and design specifications.

1-1773969-4 02/20 JN

## X-ON Electronics

Largest Supplier of Electrical and Electronic Components

*Click to view similar products for [General Purpose Relays](#) category:*

*Click to view products by [TE Connectivity](#) manufacturer:*

Other Similar products are found below :

[PCN-105D3MH,000](#) [59641F200](#) [5JO-1000CD-SIL](#) [LY1SAC110120](#) [5X827E](#) [5X837F](#) [5X840F](#) [5X842F](#) [5X848E](#) [LY2N-AC120](#) [LY2S-AC220/240](#) [LY2-US-AC120](#) [LY3-US-AC120](#) [LY4F-UA-DC12](#) [LY4F-UA-DC24](#) [LY4F-US-AC120](#) [LY4F-US-AC240](#) [LY4F-US-DC24](#) [LY4F-VD-AC110](#) [LYQ20DC12](#) [M115C60](#) [M115N010](#) [M115N0150](#) [6031007G](#) [603-12D](#) [61211T0B4](#) [61212T400](#) [61222Q400](#) [61243B600](#) [61243C500](#) [61243Q400](#) [61311BOA2](#) [61311BOA6](#) [61311BOA8](#) [61311C0A2](#) [61311COA1](#) [61311COA6](#) [61311F0A2](#) [61311QOA1](#) [61311QOA4](#) [61311T0D6](#) [61311TOA6](#) [61311TOA7](#) [61311TOB3](#) [61311TOB4](#) [61311U0A6](#) [61312Q600](#) [61312T400](#) [61312T600](#) [61313U200](#)