

LOC	DIST	REVISIONS					
-	-	P	LTR	DESCRIPTION	DATE	DWN	APVD
		BA		NEW DRAWING	25APR2012	KR	St.P

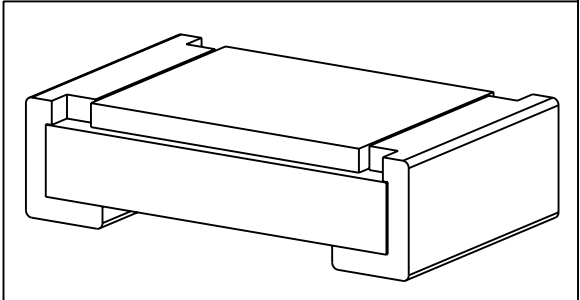

FOR FURTHER INFORMATION SEE DATA SHEET FOR
SMD HIGH POWER PRECISION RESISTORS - RP73 SERIES

RoHS Compliant



20

RELEASED FOR PUBLICATION

ALL RIGHTS RESERVED.

THIS DRAWING IS UNPUBLISHED.

BY -

© COPYRIGHT 20

DIMENSIONS: mm	DWN RAGHAVENDRA K	25APR2012	MATERIAL	-	FINISH	-	
	CHK ALLAN P	25APR2012	 TE Connectivity				
TOLERANCES UNLESS OTHERWISE SPECIFIED:	APVD STEPHEN.P	25APR2012					
	0 PLC ±	PRODUCT SPEC	NAME	HIGH POWER PRECISION CHIP RESISTORS - TYPE RP73P 0805 SERIES			
1 PLC ±0.5	-	APPLICATION SPEC	SIZE	CAGE CODE	DRAWING NO	RESTRICTED TO	
2 PLC ±0.13	-	-	A 4	00779	©-2176091	-	
3 PLC ±0.013	WEIGHT	0.005 Gram	SCALE		40:1	SHEET	1 OF 1
4 PLC ±0.0001	CUSTOMER DRAWING		REV		BA		
ANGLES ±							

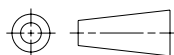

X-ON Electronics

Largest Supplier of Electrical and Electronic Components

Click to view similar products for [Thin Film Resistors - SMD category](#):

Click to view products by [TE Connectivity manufacturer](#):

Other Similar products are found below :

[M55342K06B34E0RT3](#) [D55342E07B379BR-TR](#) [AR02BTC1872](#) [AR02BTC18R7](#) [AR02BTC3830](#) [AR02BTC4220](#) [AR02BTC4422](#)
[AR02BTC5100](#) [AR02BTC5111](#) [AR02BTC5762](#) [AR02BTC8251](#) [AR02BTC8452](#) [AR03BTC0110](#) [AR03BTC0120](#) [AR03BTC0330](#)
[AR03BTC0390](#) [AR03BTC1102](#) [AR03BTC1103](#) [AR03BTC1201](#) [AR03BTC2000](#) [AR03BTC2201](#) [AR03BTC2203](#) [AR03BTC2490](#)
[AR03BTC3003](#) [AR03BTC3302](#) [AR03BTC3901](#) [AR03BTC4220](#) [AR03BTC4223N](#) [AR03BTC5602](#) [AR03BTC5603](#) [AR03BTC5900](#)
[AR03BTC7500](#) [AR03BTC9100](#) [AR03BTC9103](#) [AR03BTC9760](#) [AR05BTC0280](#) [AR05BTC1000](#) [AR05BTC1100](#) [AR05BTC1201](#)
[AR05BTC1202](#) [AR05BTC1300](#) [AR05BTC14R3](#) [AR05BTC1500](#) [AR05BTC1523](#) [AR05BTC1620](#) [AR05BTC1622](#) [AR05BTC1623](#)
[AR05BTC1760](#) [AR05BTC1800](#) [AR05BTC1823](#)