

LOC		DIST		REVISIONS			
P	LTN	DESCRIPTION	DATE	DWN	APVD		
C		REVISED PER ECR-21-100678	08APR2021	SS	VS		

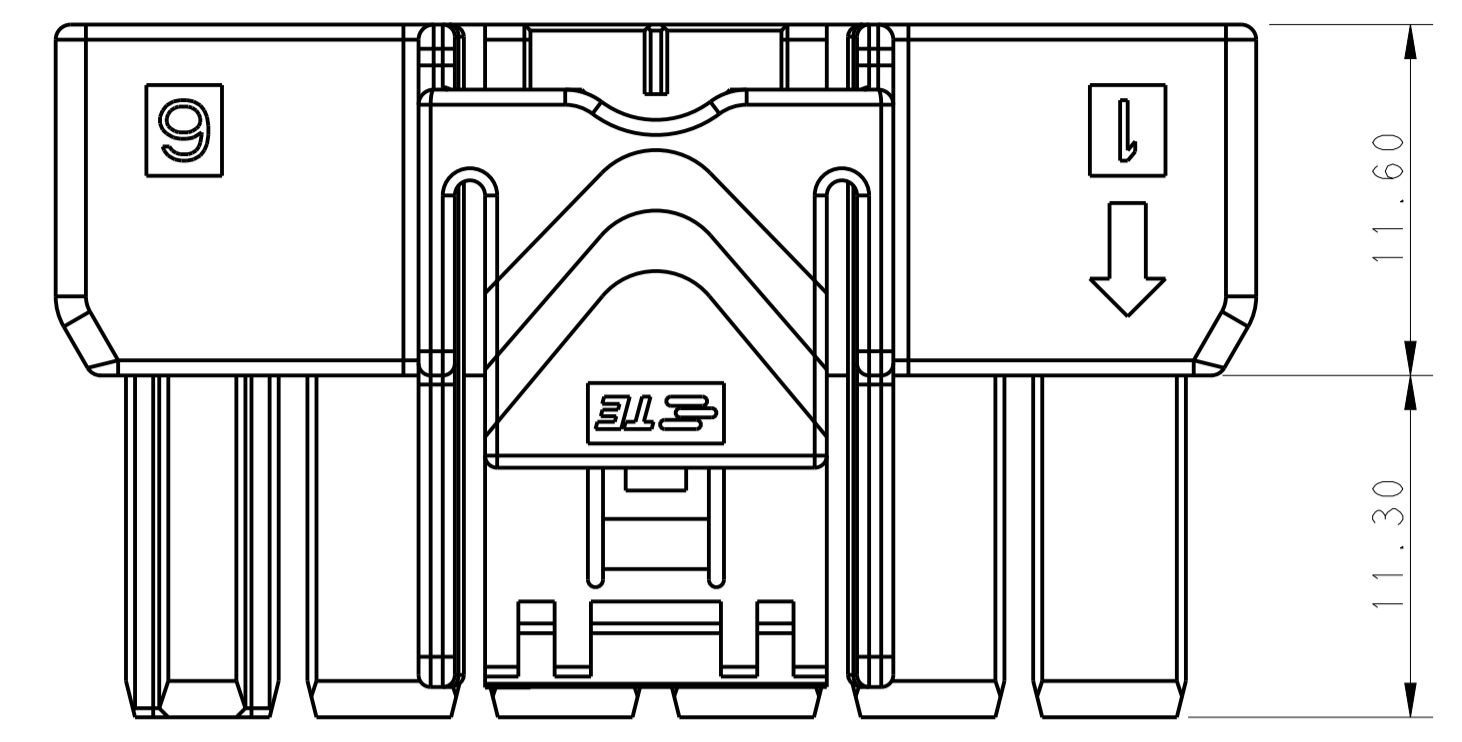

POS.	DIM. A
2*6	39.70
2*5	33.70
2*4	27.70
2*3	21.70

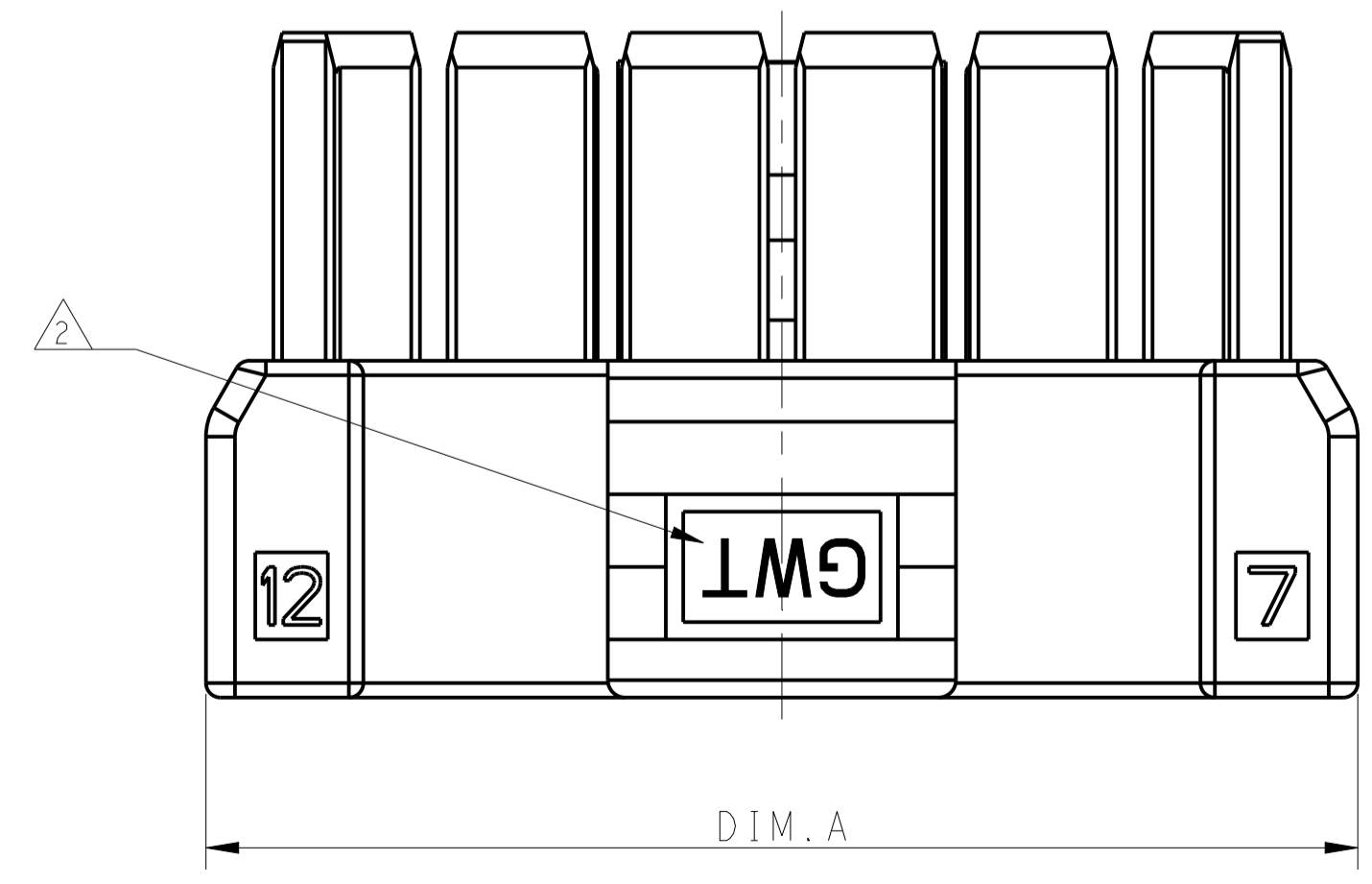
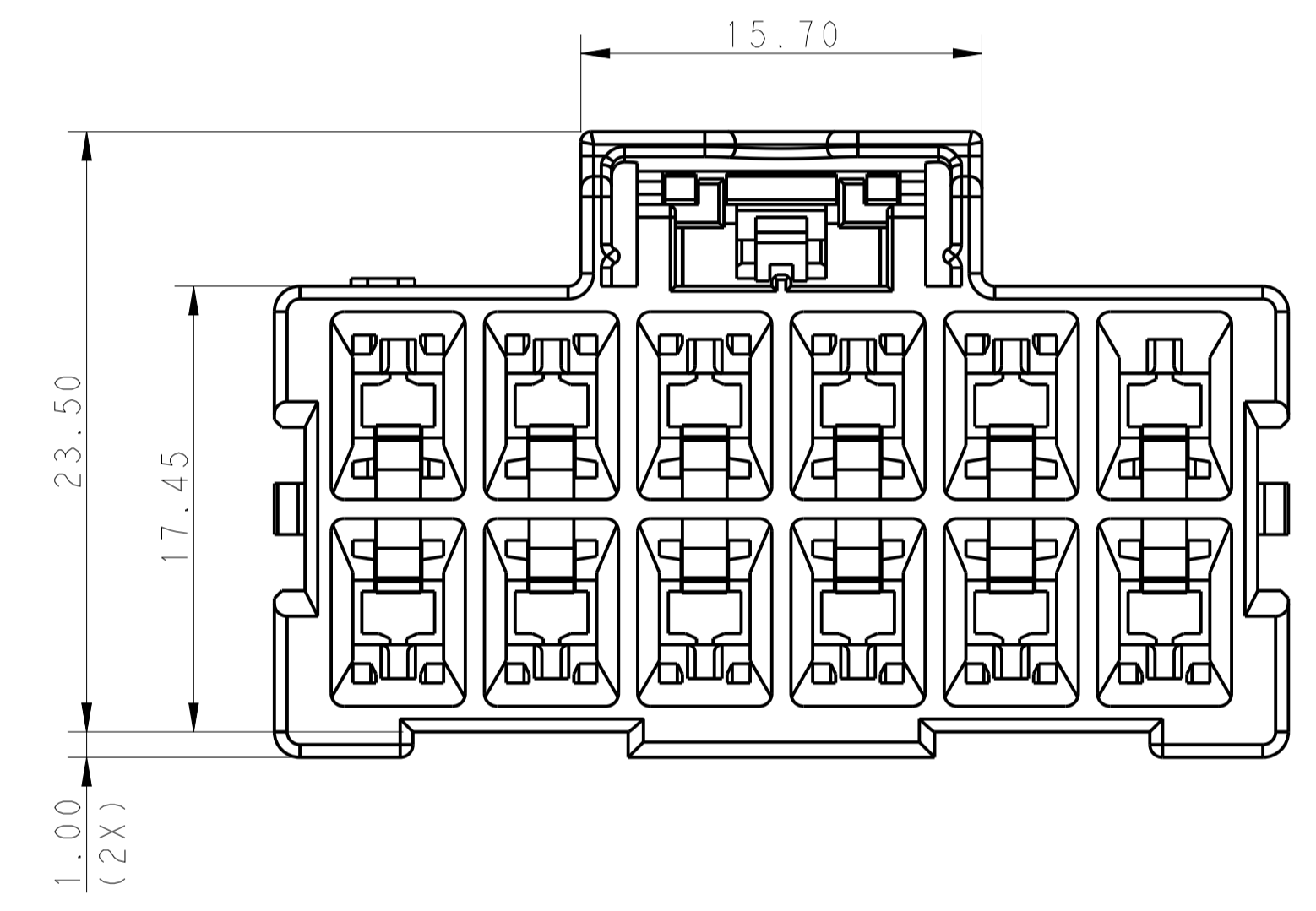
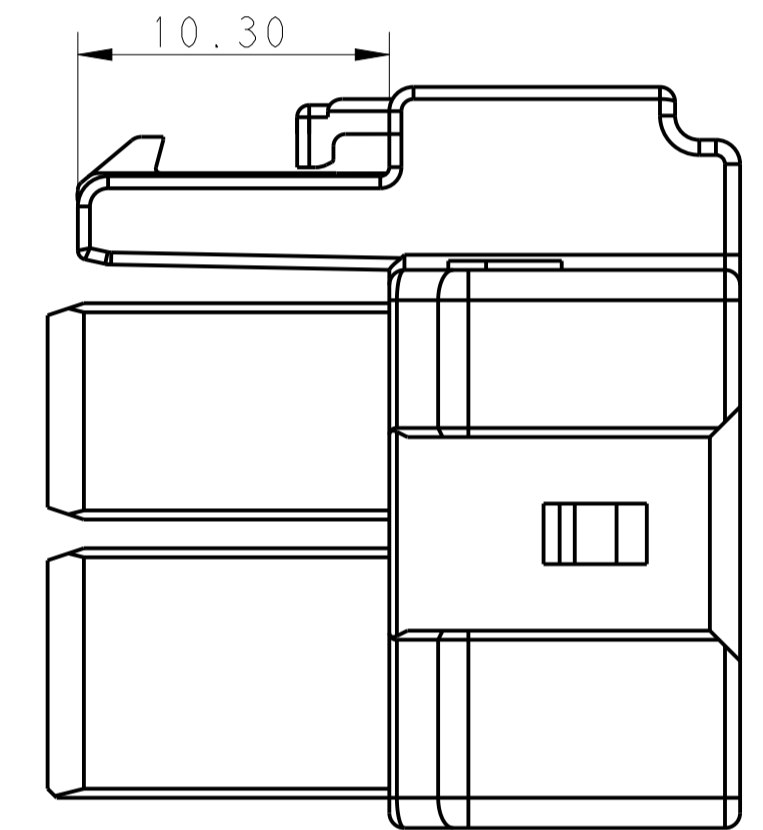
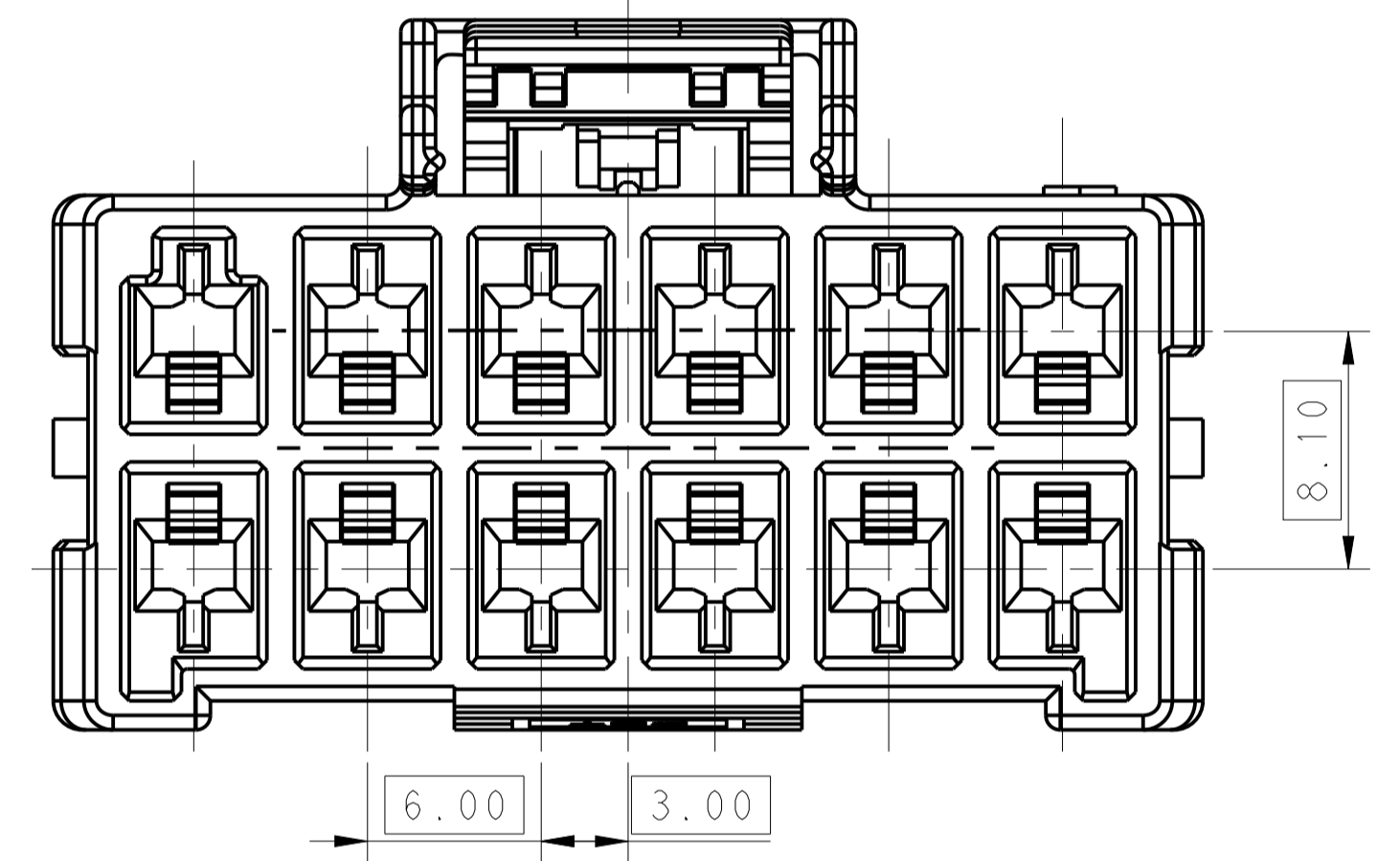

- NOTE
- MATERIAL:
 - LEVEL A: PA6, COMPLY WITH GLOW WIRE REQUIREMENTS FOR PARTS OF NON-METALLIC MATERIAL SUPPORTING A CURRENT-CARRYING CONNECTION DETAILED IN IEC 60335-1, SECTION 30 (GWT), UL 94V-0
 - LEVEL B: PBT, HOT WIRE IGNITION (HWI) VERSION ARE MOLDED IN A RESIN THAT COMPLIES WITH TE PENDING HOT WIRE IGNITION TEST AND ARE RECOMMENDED FOR USE WITH HWI HOUSINGS THAT ALSO COMPLY, UL 94V-0
 - MATERIAL MARK:
 - LEVEL A:GWT,LEVEL B:HWT
 - APPLICABLE CONTACT P/N
 RECEPTACLE CONTACT:1971237/1971779/81/83/85/87-*,2238066-*
 - MATING CONN, P/N
 CAP HSG: *-2232359/264-
 TPA: *-1971778-*

THIS DRAWING IS A CONTROLLED DOCUMENT.		DWG: TOMMY WU 26MAR2013		TE Connectivity	
DIMENSIONS: mm		CHK: HAPYE WU 26MAR2013			
TOLERANCES UNLESS OTHERWISE SPECIFIED:		APVD: YIHONG MAO 26MAR2013		NAME: PLUG HOUSING, DOUBLE ROW POWER TRIPLE LOCK	
0 PLC ±0.35		PRODUCT SPEC: 108-106118		SIZE: A1	
2 PLC ±0.25		APPLICATION SPEC: 114-106118		CAGE CODE: 2232266	
3 PLC ±0.25		WEIGHT: -		RESTRICTED TO: -	
4 PLC ±0.25		MATERIAL: -		SCALE: -	
ANGLES ±0.5		FINISH: -		SHEET 1 OF 2	
MATERIAL: -		FINISH: -		REV C	
MATERIAL: -		FINISH: -		Customer Drawing	

LOC		DIST		REVISIONS			
P	LTN	DESCRIPTION	DATE	OWN	APVD		
-	-	SEE SHEET 1	-	-	-	-	-

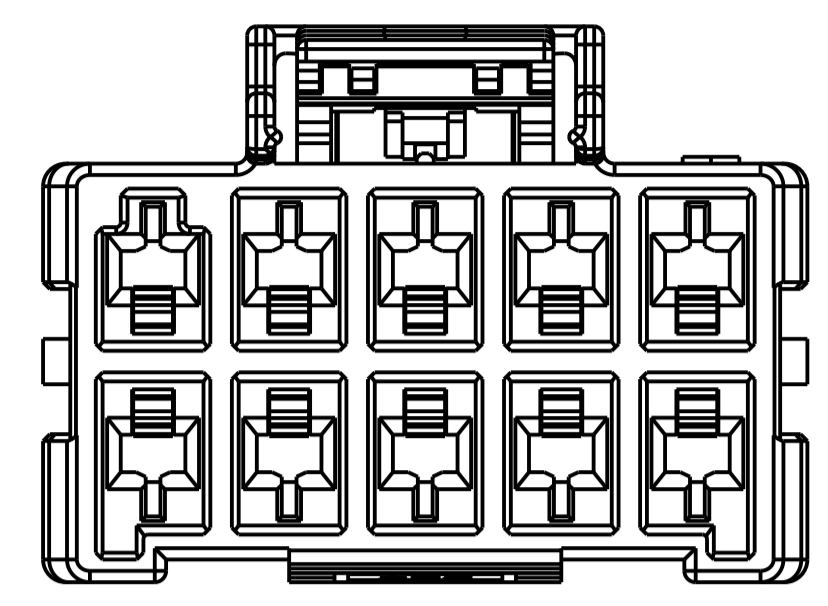
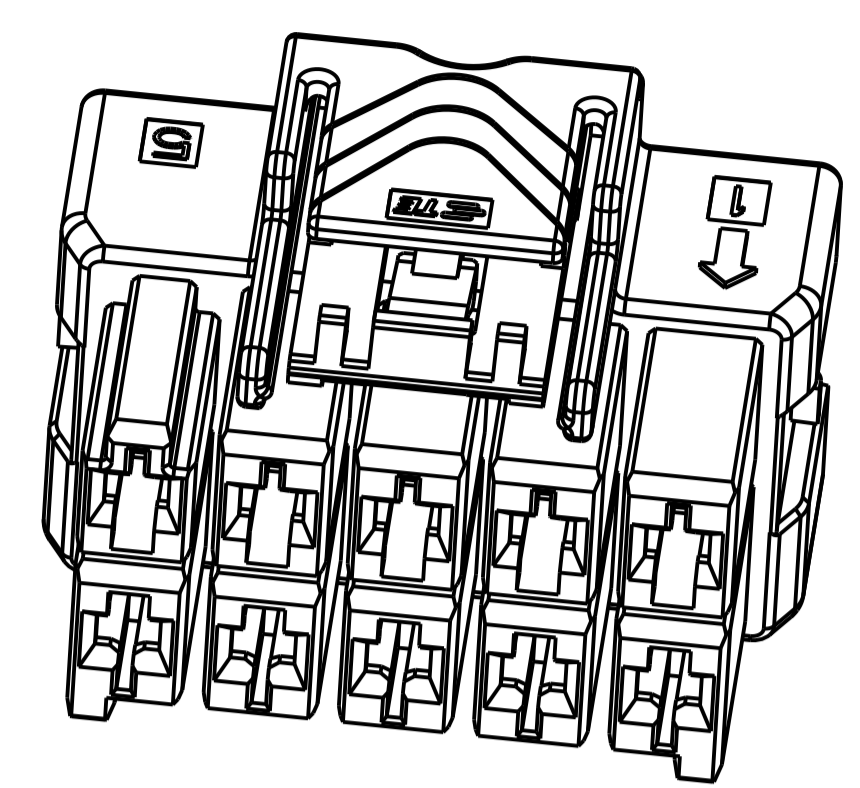

2*5 POSITIONS

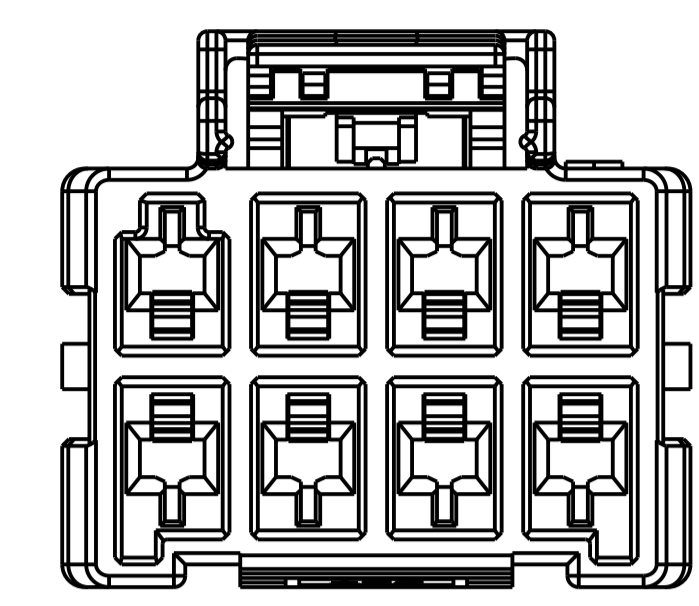
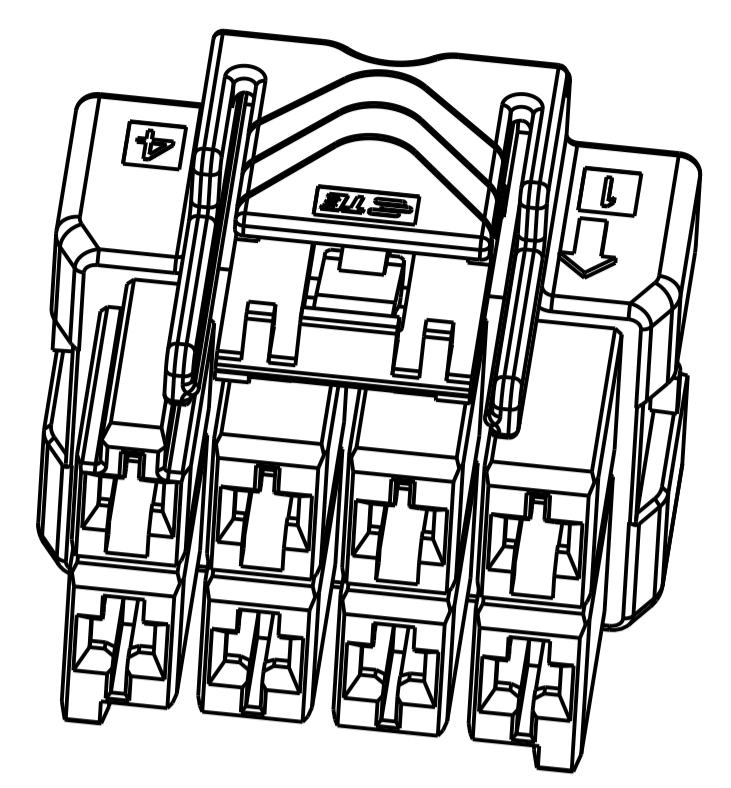

2*4 POSITIONS

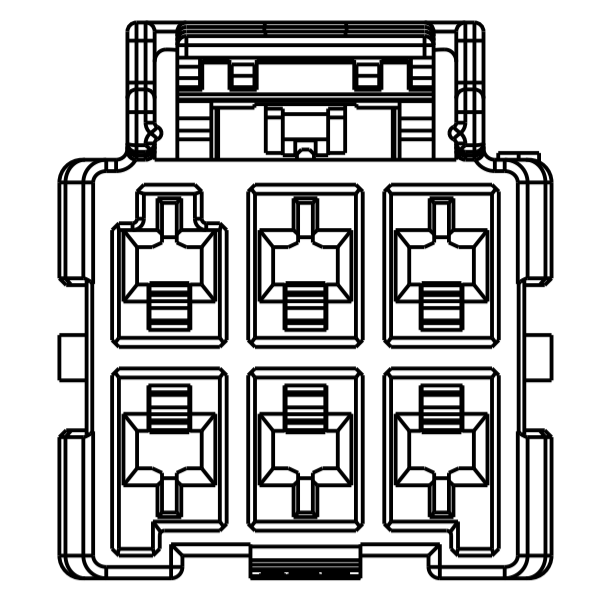
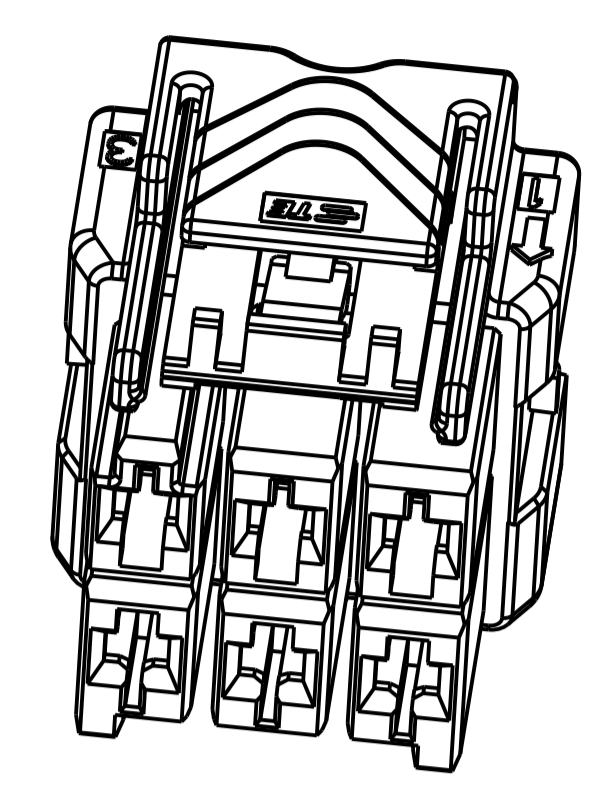

2*3 POSITIONS

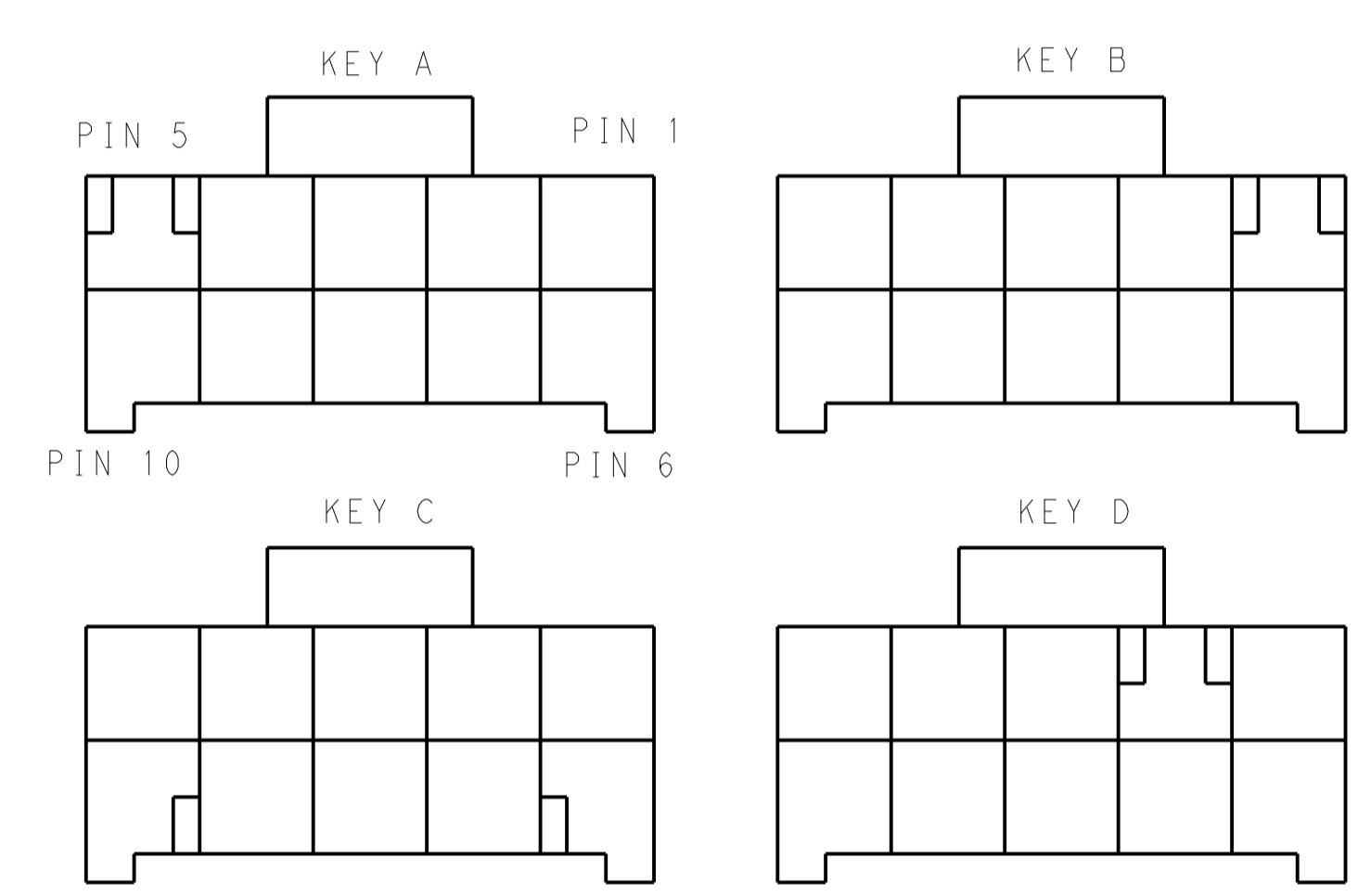

KEYING FOR 2*5 POS.

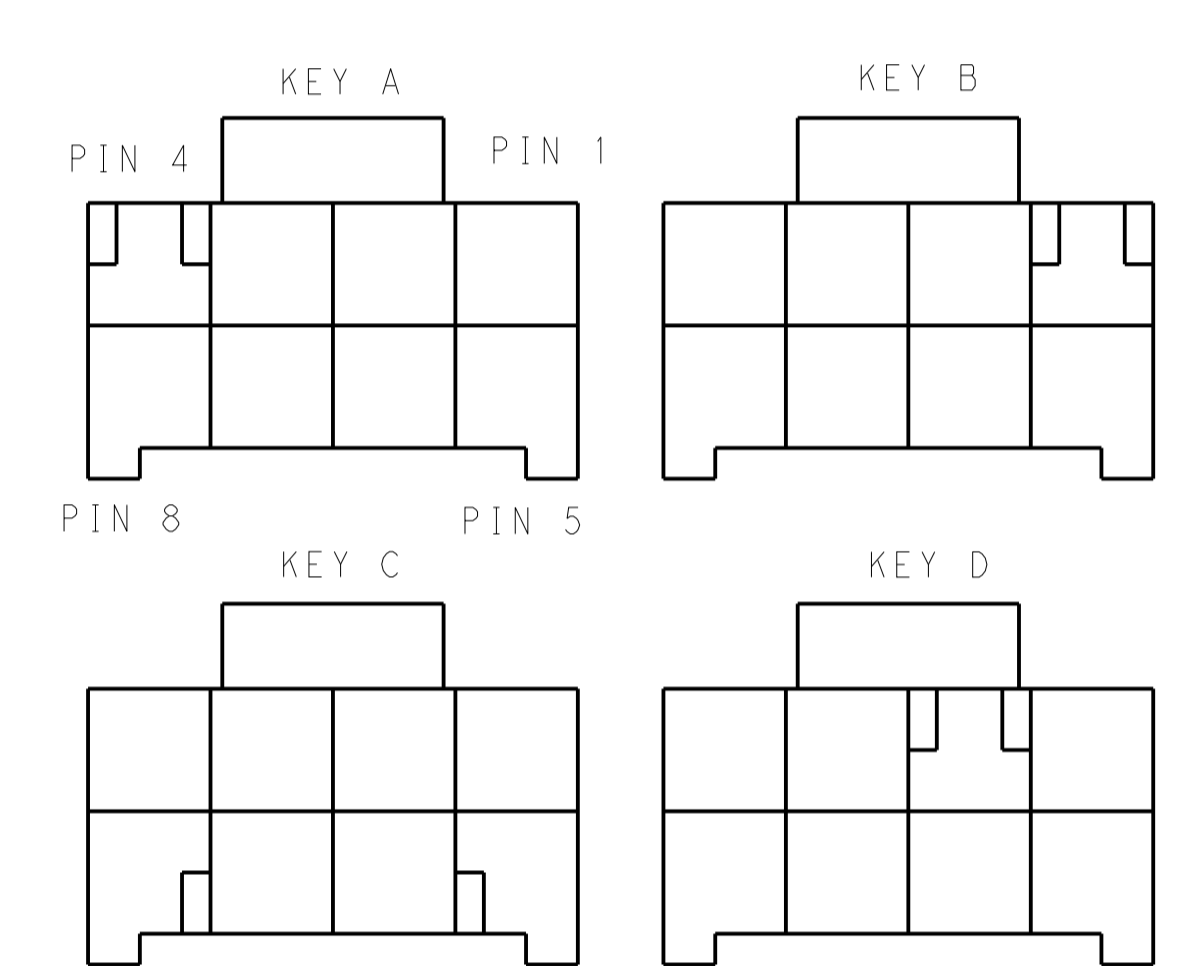

KEYING FOR 2*4 POS.

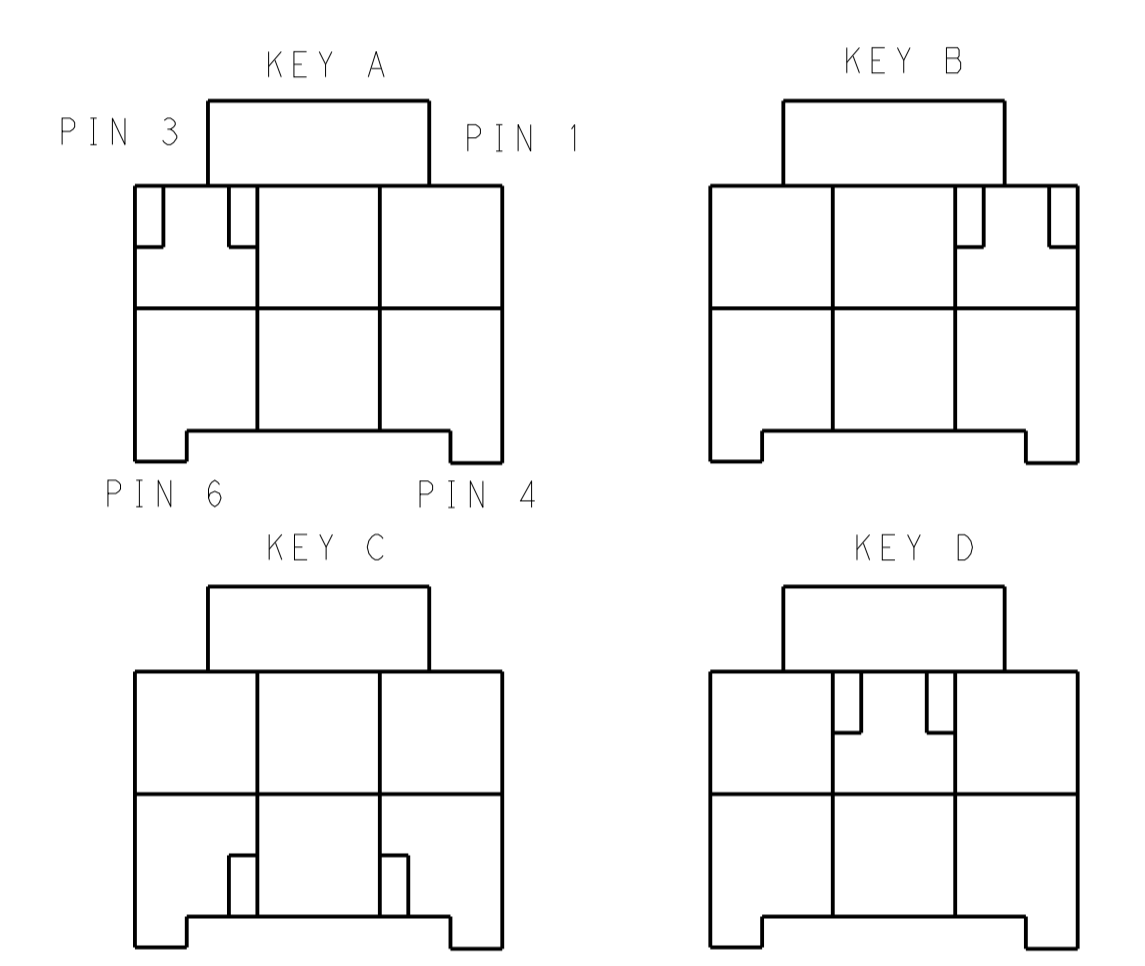

KEYING FOR 2*3 POS.

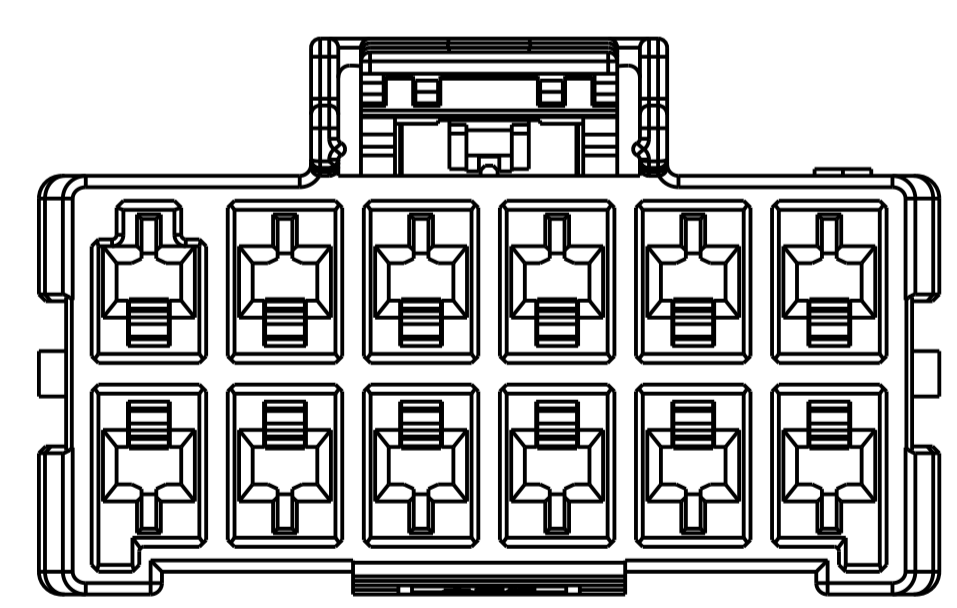
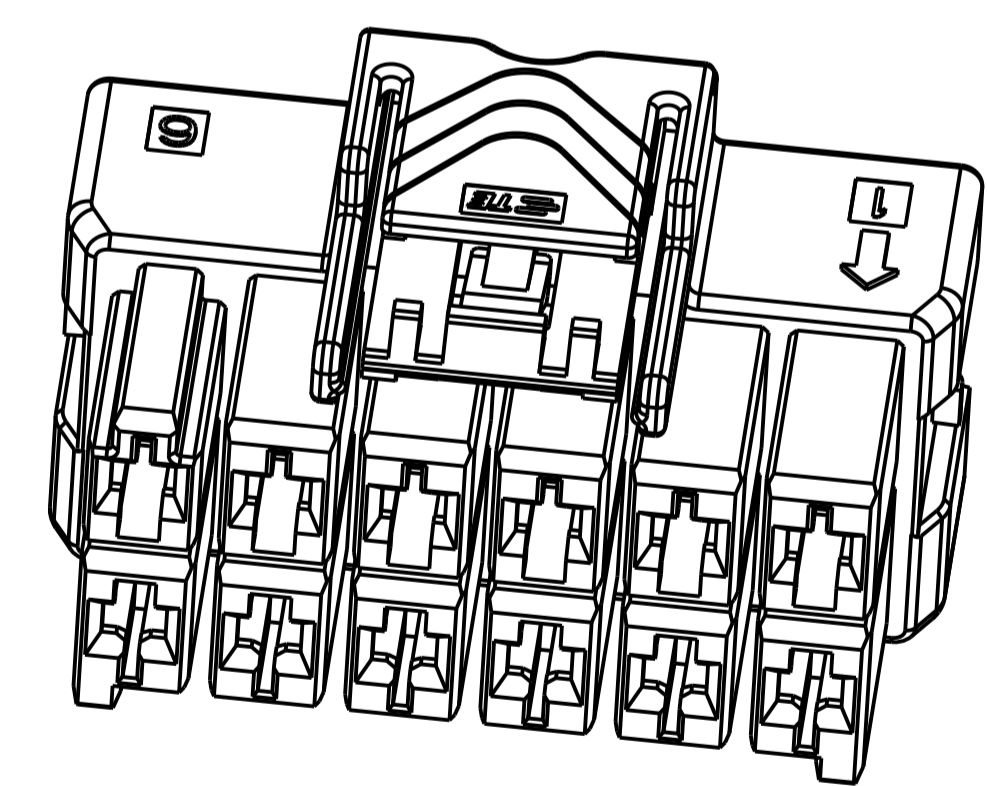

2*6 POSITIONS

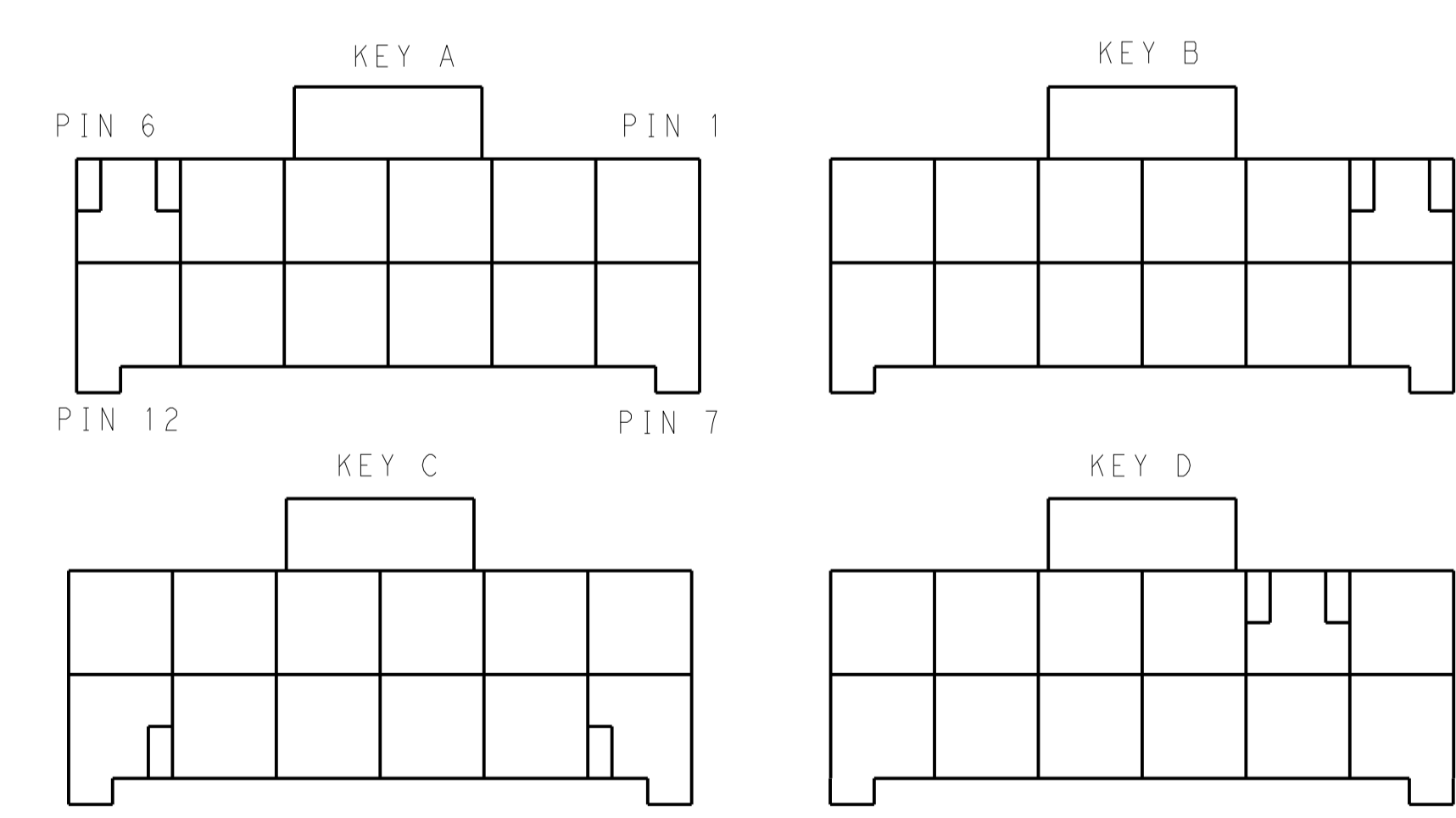

KEYING FOR 2*6 POS.

POS.	MATERIAL	COLOR	KEY	P/N
2*6	LEVEL A	DARK GREY	KEY A	5-2232266-6
		BROWN	KEY B	6-2232266-6
		GREEN	KEY C	7-2232266-6
		ORANGE	KEY D	8-2232266-6
2*5	LEVEL A	DARK GREY	KEY A	5-2232266-5
		BROWN	KEY B	6-2232266-5
		GREEN	KEY C	7-2232266-5
		ORANGE	KEY D	8-2232266-5

POS.	MATERIAL	COLOR	KEY	P/N
2*4	LEVEL A	DARK GREY	KEY A	5-2232266-4
		BROWN	KEY B	6-2232266-4
		GREEN	KEY C	7-2232266-4
		ORANGE	KEY D	8-2232266-4
2*4	LEVEL B	BLACK	KEY A	1-2232266-4
		BLACK	KEY A	1-2232266-4
2*3	LEVEL A	DARK GREY	KEY A	5-2232266-3
		BROWN	KEY B	6-2232266-3
		GREEN	KEY C	7-2232266-3
		ORANGE	KEY D	8-2232266-3
2*3	LEVEL B	BLACK	KEY A	1-2232266-1
		BLACK	KEY A	1-2232266-1

THIS DRAWING IS A CONTROLLED DOCUMENT.

OWN: TOMMY_WU 26MAR2013
 CHK: TOMMY_WU 26MAR2013
 APVD: HAPYE_WU 26MAR2013
 YIYHONG_MAO 26MAR2013

STE TE Connectivity

NAME: PLUG HOUSING, DOUBLE ROW POWER TRIPLE LOCK

PRODUCT SPEC: 108-106118
 APPLICATION SPEC: 114-106118

SIZE: A1 CAGE CODE: 00779 DRAWING NO: 2232266

RESTRICTED TO: Customer Drawing

SCALE: SHEET 2 OF 2 REV C

X-ON Electronics

Largest Supplier of Electrical and Electronic Components

Click to view similar products for [Headers & Wire Housings](#) category:

Click to view products by [TE Connectivity](#) manufacturer:

Other Similar products are found below :

[892-18-020-10-001101](#) [58102-G61-06LF](#) [582553-1](#) [0009485154](#) [009176003701906](#) [0050291907](#) [LY20-4P-DT1-P1E-BR](#) [02.125.8002.8](#)
[609-3404](#) [61062-3](#) [61082-181009](#) [622-3653LF](#) [63453-116](#) [636-1030](#) [636-1427](#) [636-3427](#) [636-4007](#) [641938-9](#) [641991-4](#) [644827-2](#) [65817-010LF](#) [65817-015LF](#) [65863-015LF](#) [66207-023LF](#) [67095-007LF](#) [67601157](#) [68645-018](#) [68648-049](#) [70.362.1628.0](#) [70-4210](#) [70-4226B](#) [70-4853B](#) [707-5020](#) [707-5028](#) [71.350.2428.0](#) [71918-208LF](#) [71961-016LF](#) [733-134](#) [733-162](#) [754199-000](#) [760-3052](#) [787-8014-00](#) [79531-3000](#)
[FCN-360C032-B](#) [FCN-367T-T012/H](#) [FCN-723D010/2](#) [80.063.4001.1](#) [800-90-001-10-001000](#) [800-90-010-10-002000](#) [801-43-002-10-013000](#)