

P	LTR	DESCRIPTION	DATE	DWN	APVD
	D5	ECN-21-114380:ADD MATED CONDITION	31AUG2021	A.L	H.L

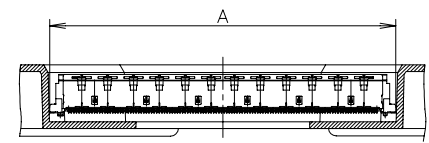

SECT. D-D
(SCALE 2:1)
(CONNECTOR NOT SECTION)

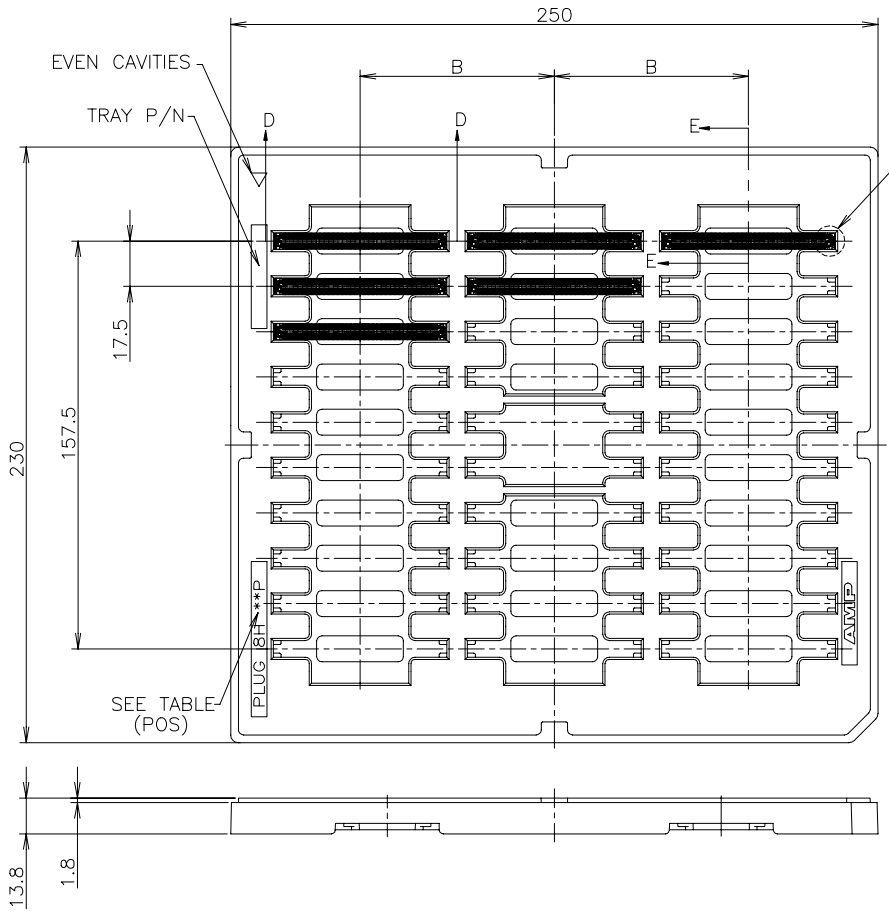
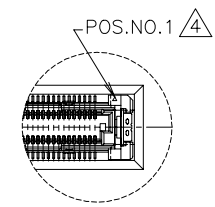

DETAIL C
(SCALE 2:1)

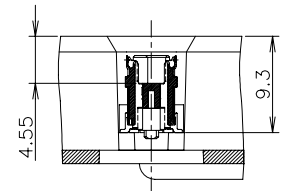

SECT. E-E
(SCALE 2:1)

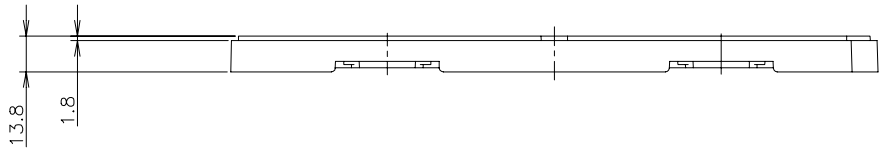

WITHOUT PICK UP CAP

THIS DRAWING IS A CONTROLLED DOCUMENT.

DIMENSIONS:	TOLERANCES UNLESS OTHERWISE SPECIFIED:
MM	
	0 PLC ± 0.3
	1 PLC ± 0.3
	2 PLC ± 0.3
	3 PLC ± 0.3
	4 PLC ± 0.3
	ANGLES ± 3'

DWN	S. CHIEN	26SEP05
CHK	T. FUTATSUGI	26SEP05
APVD	W. KODAMA	26SEP05
PRODUCT SPEC	108-5560	
APPLICATION SPEC		
WEIGHT		
CUSTOMER DRAWING		

YES	NO	SEALANT	ROW	QTY	B	A	POS.	PART NO.
YES Δ	3	30	75	61.8	220	8-6318491-6		
NO	3	30	75	61.8	220	3-6318491-6		



NAME				HARD TRAY ASSY			
FH 0.5BTB CONNECTOR 220POS				PLUG 8H WITH GROUND PLATE			
SIZE	CAGE CODE	DRAWING NO	RESTRICTED TO				
A3	00779	C=6318491					
SCALE 1:2			SHEET 1 OF 5		REV D5		

REVISIONS					
P	LTR	DESCRIPTION	DATE	DWN	APVD
-	-	SEE SHEET 1	-	-	-

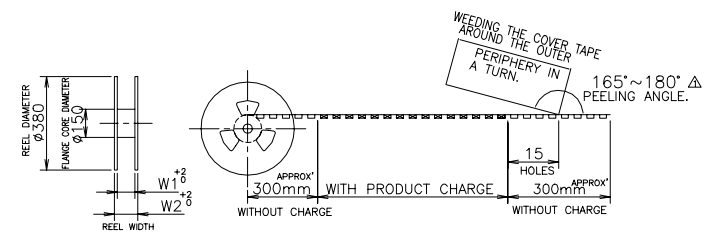
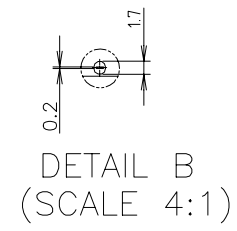
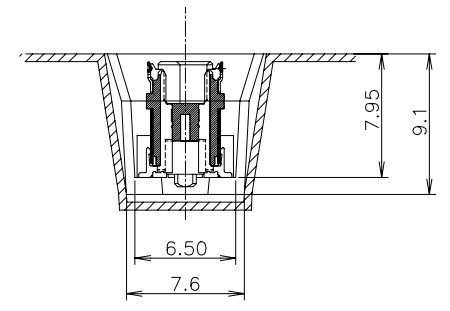
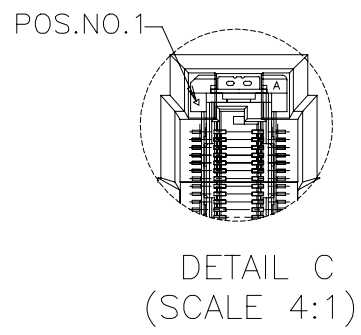
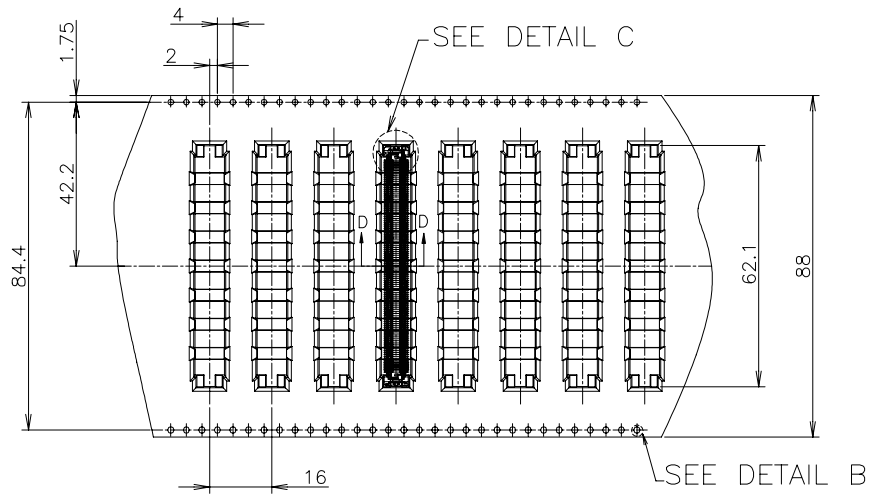

WITHOUT PICK UP CAP

NO	Y	400	93.5	88.5	220	2078455-1	3-5353619-6	4-6318491-6
SEALANT	TOOLING AVAIL	QTY/REEL	W2	W1	POS.	EMBOSS P/N	CONN P/N	PART NO.
THIS DRAWING IS A CONTROLLED DOCUMENT.						DWN S.CHIEN 26SEP05 CHK T.FUTATSUGI 26SEP05 APVD W.KODAMA 26SEP05 PRODUCT SPEC APPLICATION SPEC 108-5560		
DIMENSIONS: MM		TOLERANCES UNLESS OTHERWISE SPECIFIED:		NAME HARD TRAY ASSY FH 0.5BTB CONNECTOR 220POS PLUG 8H WITH GROUND PLATE				
		0 PLC ± 0.3 1 PLC ± 0.3 2 PLC ± 0.3 3 PLC ± 0.3 4 PLC ± 0.3 ANGLES ± 3°		MATERIAL		FINISH		RESTRICTED TO
CUSTOMER DRAWING			WEIGHT	SIZE A3	CAGE CODE 00779	DRAWING NO. C=6318491	SCALE 1:2 SHEET 2 OF 5 REV D5	

REVISIONS					
P	LTR	DESCRIPTION	DATE	DWN	APVD
-	-	SEE SHEET 1	-	-	-

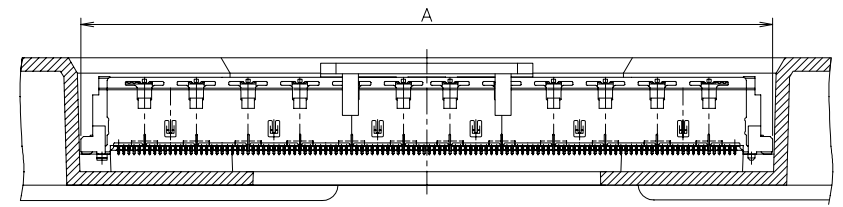
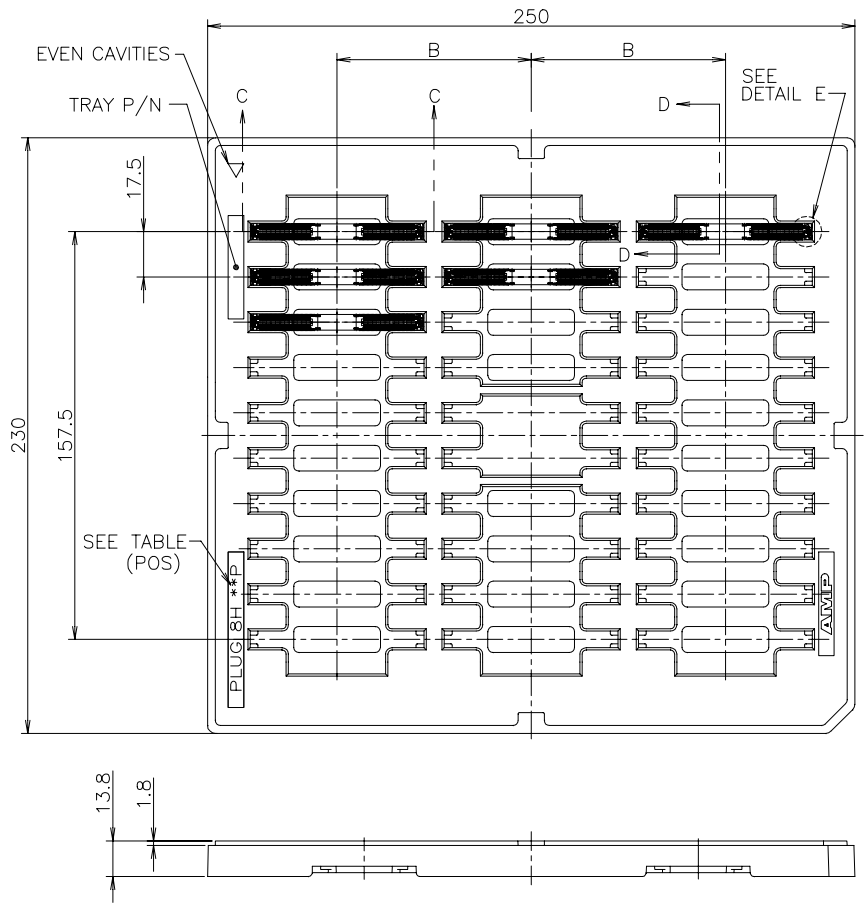

SECT. C-C
(SCALE 2:1)

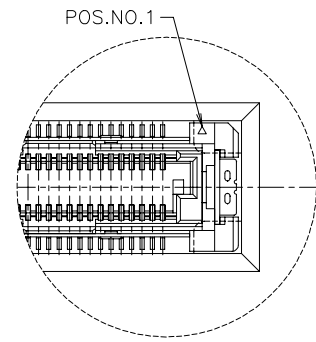

DETAIL E
(SCALE 4:1)

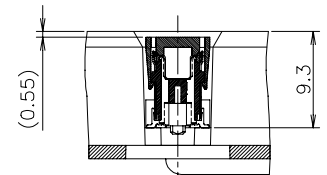

SECT. D-D
(SCALE 2:1)

WITH PICK UP CAP

NATURAL	NO	3	30	75	61.8	220	6-6318491-6
BLACK	NO	3	30	75	61.8	220	9-6318491-6
CAP COLOR	SEALANT	ROW	QTY	B	A	POS.	PART NO.

THIS DRAWING IS A CONTROLLED DOCUMENT.		DWN S. CHIEN	TE Connectivity Ltd.				
		CHK T. FUTATSUGI					
		APVD W. KODAMA	NAME				
		PRODUCT SPEC 108-5560	HARD TRAY ASSY FH 0.5BTB CONNECTOR 220POS PLUG 8H WITH GROUND PLATE				
		APPLICATION SPEC	RESTRICTED TO				
		WEIGHT	SIZE A3	CAGE CODE 00779	DRAWING NO C=6318491		
		CUSTOMER DRAWING	SCALE 1:2		SHEET 3 OF 5	REV D5	

DIMENSIONS: MM	TOLERANCES UNLESS OTHERWISE SPECIFIED:
	0 PLC ± 0.3
	1 PLC ± 0.3
	2 PLC ± 0.3
	3 PLC ± 0.3
	4 PLC ± 0.3
	ANGLES ± 3'

P	LTR	DESCRIPTION	DATE	DWN	APVD
-	-	SEE SHEET 1	-	-	-

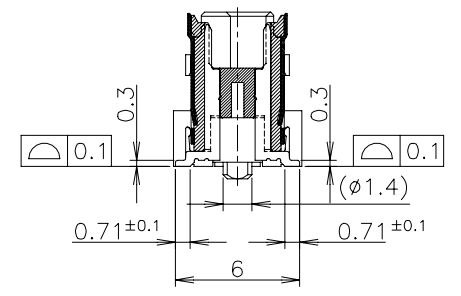
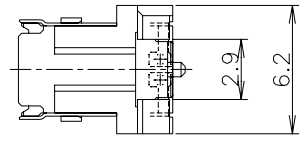
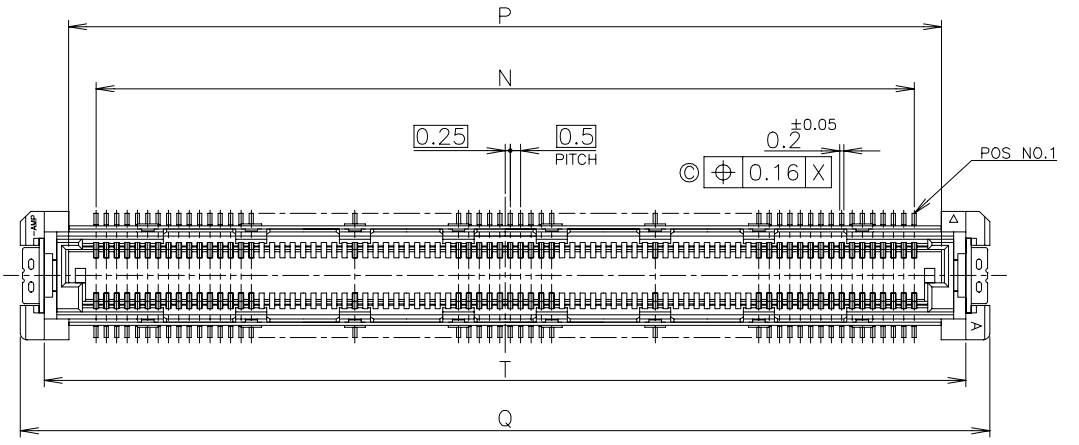

SECT. Z-Z
(SIGNAL POSITION)

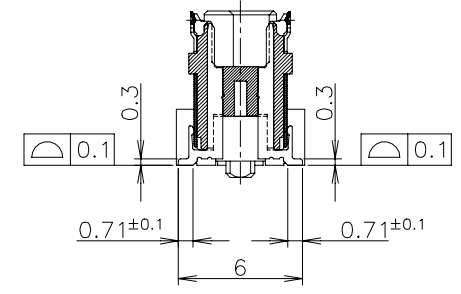
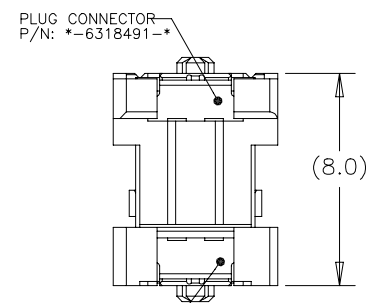
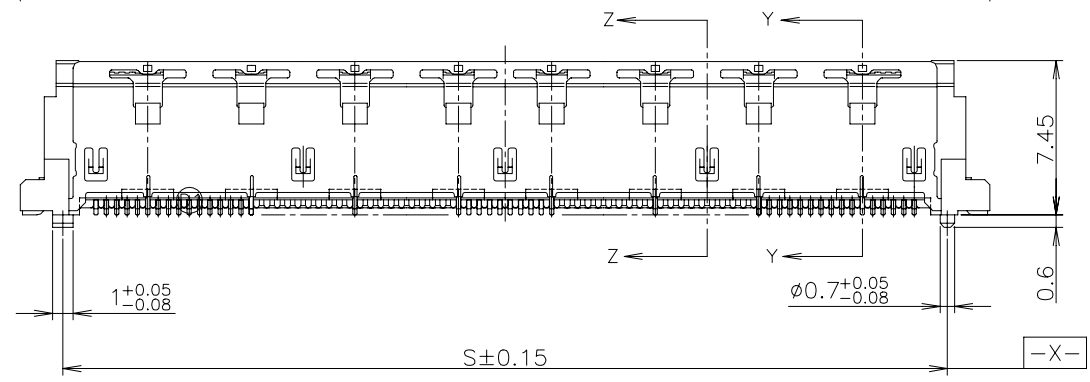

SECT. Y-Y
(GROUND POSITION)

Ⓜ FULL-MATED CONDITION

- NOTE:**
- ① MATERIAL ; HOUSING : HIGH TEMP THERMO PLASTIC UL94V-0
CONTACT : COPPER ALLOY
SOLDER PEG : COPPER ALLOY
 - ② FINISH ; SIGNAL CONTACT : UNDER PL Ni 0.0013mm MIN ALL OVER.
CONTACT AREA 0.0002mm MIN Au PL.
SOLDERING AREA 0.001mm MIN TIN PL.
GROUND CONTACT : UNDER PL Ni 0.0013mm MIN ALL OVER.
CONTACT AREA 0.0002mm MIN Au PL.
SOLDERING AREA 0.001mm MIN TIN PL.
SOLDER PEG : 0.001mm MIN TIN PL. OVER
0.0013mm MIN Ni PL ALL OVER.
 - ③ THIS POSITION IS GROUND CIRCUIT.
 - ④ THIS PRODUCT WAS COATED BY FLUX-PENETRATION-INHIAITING AGENT.

59.5	57.7	61.8	57.1	54.5	220	BLACK	X-6318491-6
T	S	Q	P	N	POS.	HSG COLOR	PART NO.

THIS DRAWING IS A CONTROLLED DOCUMENT.

DIMENSIONS: MM	TOLERANCES UNLESS OTHERWISE SPECIFIED:	DWN	TE Connectivity Ltd. HARD TRAY ASSY FH 0.5BTB CONNECTOR 220POS PLUG 8H WITH GROUND PLATE
	0 PLC ± 0.3 1 PLC ± 0.3 2 PLC ± 0.3 3 PLC ± 0.3 4 PLC ± 0.3 ANGLES ± 3'	CHK	
MATERIAL	FINISH	APVD	
①	②	PRODUCT SPEC	
		APPLICATION SPEC	NAME
		WEIGHT	SIZE
		CUSTOMER DRAWING	CAGE CODE
			DRAWING NO
			RESTRICTED TO
			A3 00779 C=6318491
		SCALE	4:1
		SHEET	4 OF 5
		REV	D5

REVISIONS

P	LTR	DESCRIPTION	DATE	DWN	APVD
-	-	SEE SHEET 1	-	-	-

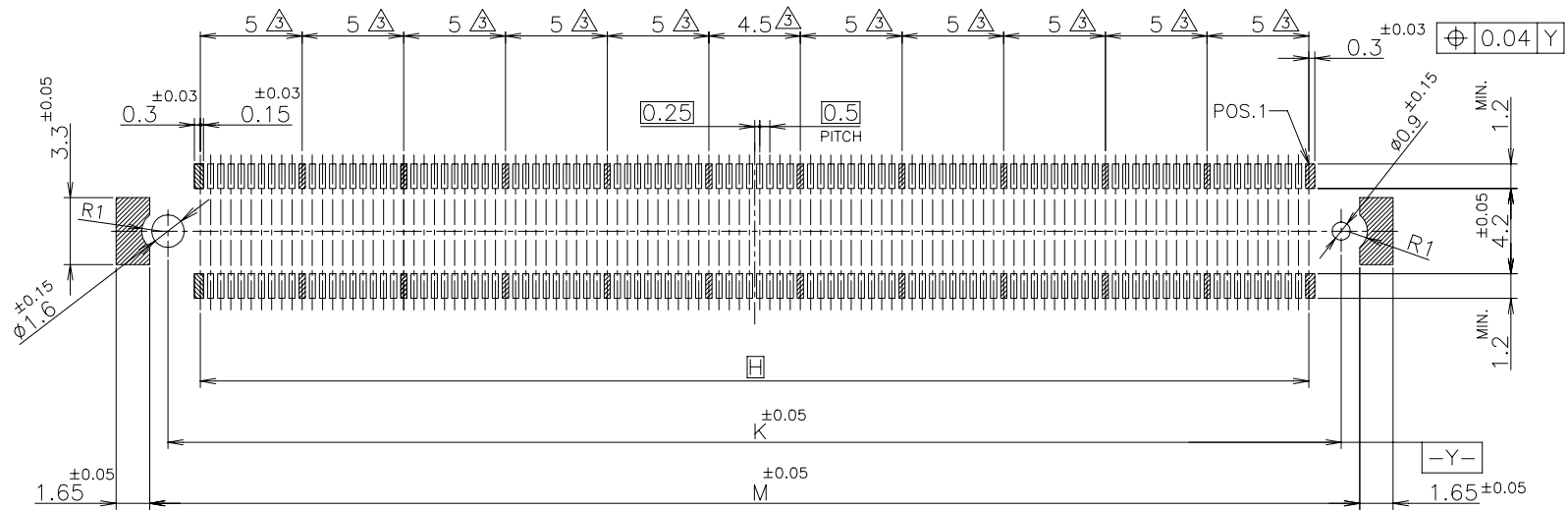

REFERENCE P.C. BOARD LAYOUT

59.5	57.7	54.5	220	X-6318491-6
M	K	H	POS	PART NO.

THIS DRAWING IS A CONTROLLED DOCUMENT.		DWN	TE Connectivity Ltd.			
DIMENSIONS: MM		CHK				
TOLERANCES UNLESS OTHERWISE SPECIFIED:		APVD	NAME HARD TRAY ASSY FH 0.5BTB CONNECTOR 220POS PLUG 8H WITH GROUND PLATE			
0 PLC ± 0.3 1 PLC ± 0.3 2 PLC ± 0.3 3 PLC ± 0.3 4 PLC ± 0.3 ANGLES ± 3°		PRODUCT SPEC				
MATERIAL	FINISH	APPLICATION SPEC	SIZE	CAGE CODE	DRAWING NO	RESTRICTED TO
1	2	WEIGHT	A3	00779	C=6318491	
CUSTOMER DRAWING			SCALE	SHEET	REV	
			4:1	5 OF 5	D5	

X-ON Electronics

Largest Supplier of Electrical and Electronic Components

Click to view similar products for [Board to Board & Mezzanine Connectors](#) category:

Click to view products by [TE Connectivity](#) manufacturer:

Other Similar products are found below :

[589158040000018](#) [MDF7C-18P-2.54DSA\(55\)](#) [FCN-230C068-11](#) [FCN-268F012-G/BD](#) [FCN-268F036-G/BD](#) [FCN-268M012-G/0D](#) [FCN-268M024-G/1D](#) [FCN-723J004/1](#) [MIS-048-01-F-D-DP-K](#) [832-10-034-10-001000](#) [FX4C-80S-1.27DSA](#) [FCN-214Q030-G/0](#) [FCN-234P048-G/0](#) [FCN-235D050-G/C](#) [210-93-314-41-105000](#) [2-22603-0](#) [MDF7-40DP-2.54DSA\(55\)](#) [AXG720047](#) [5031084030](#) [MIT-114-03-F-D-K](#) [55323-1519](#) [DF33-2P-3.3DSA\(24\)](#) [YFT-20-05-H-03-SB-K](#) [503308-3040](#) [026-6203-PDB](#) [027-6203-PDB](#) [069159702701000](#) [10123981-102LF](#) [101A10019X](#) [55650-0588-C](#) [68682-310LF](#) [68684-306](#) [75140-7012](#) [87471-650](#) [YTW-30-07-H-Q-410-140](#) [194261-1](#) [FCN-268F024-G0D](#) [10124054-515LF](#) [68685-603](#) [8-1616154-3](#) [MIS-019-01-F-D](#) [FCN-268M024-G/3D](#) [20021832-06016C1LF](#) [KX15-20KLDL-E1000E](#) [MDF7-16DP-2.54DSA\(55\)](#) [AXE810124](#) [FCN-214J100-G/0](#) [FCN-230C068-E/S](#) [AXE812124](#) [AXE816124](#)