

THIS DRAWING IS UNPUBLISHED. RELEASED FOR PUBLICATION. ALL RIGHTS RESERVED.

REVISIONS					
P	LTR	DESCRIPTION	DATE	DWN	APVD
	R4	PART STATUS UPATED IN PART LIST TABLE	16FEB2018	SD	PS

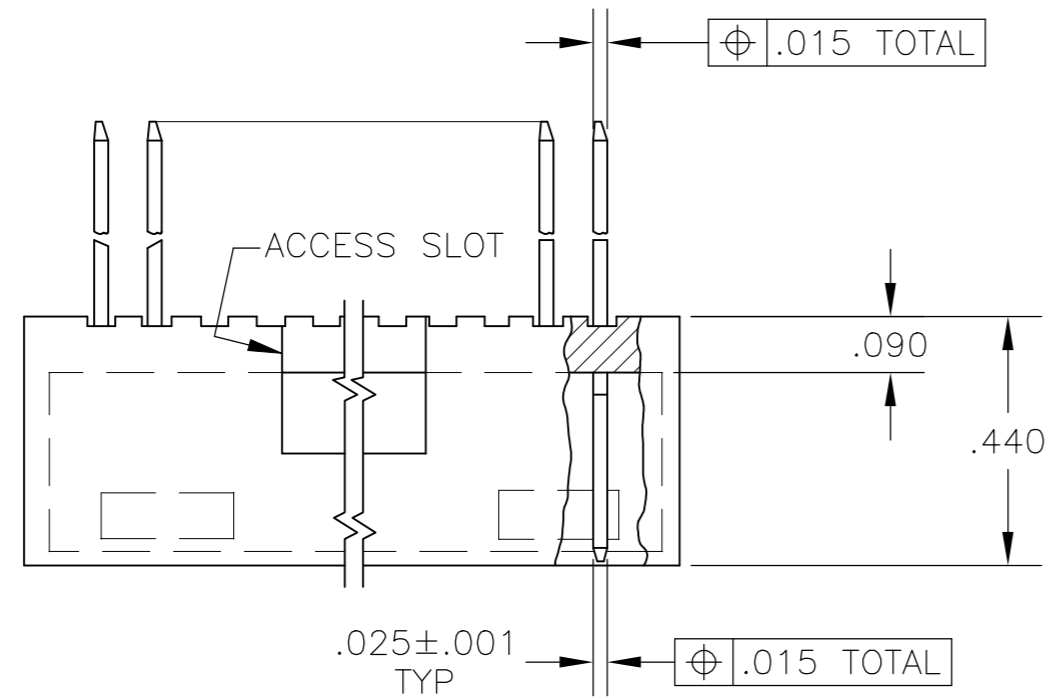

NOTES

- 1 WILL ALSO MATE W/OTHER CONNECTORS WHICH ARE COMPATIBLE WITH THE $.006$ END DIM.
- 2 OBSOLETE PART NUMBER.
- 3 $.000100$ -. $.000200$ BRIGHT TIN-LEAD OVER $.000050$ NICKEL
- 4 $.000100$ -. $.000200$ BRIGHT TIN OVER $.000050$ -. $.000100$ NICKEL
- 5 PRELIMINARY PART.
- 6 $.000100$ -. $.000200$ MATTE TIN OVER $.000050$ -. $.000100$ NICKEL
- 7 OBSOLETE PARTS: OBSOLETE CIS STREAMLINING PER D.RENAUD/D.SINISI

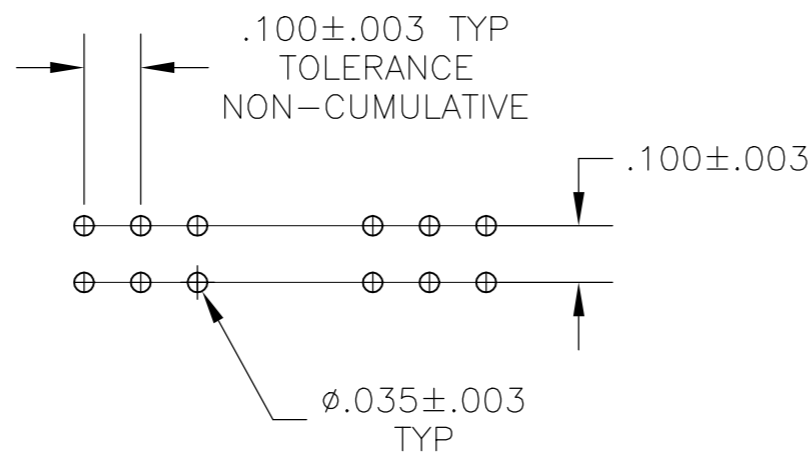
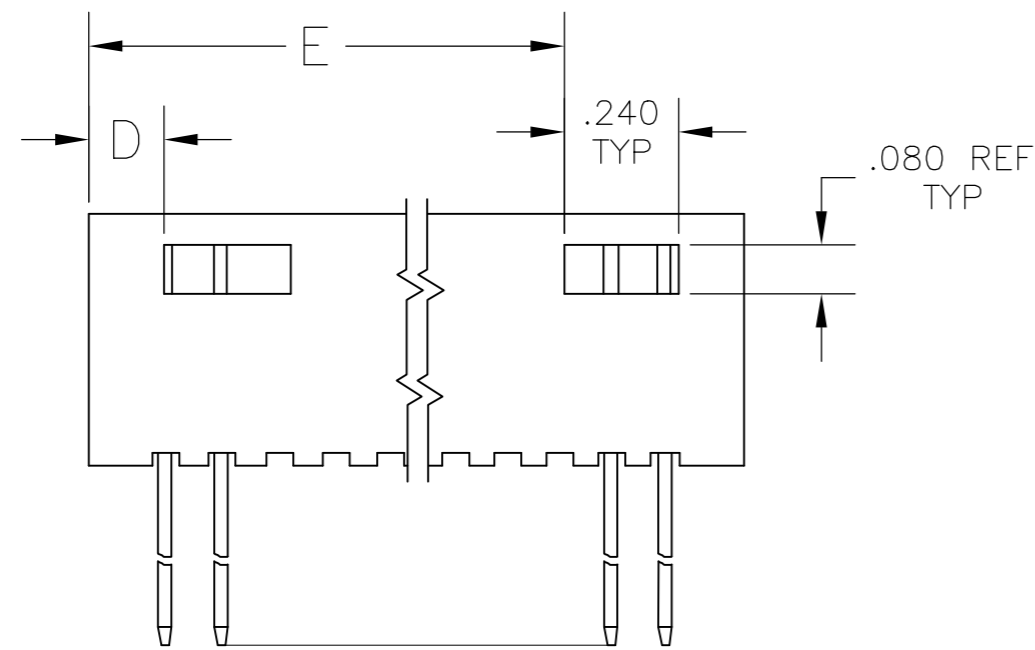
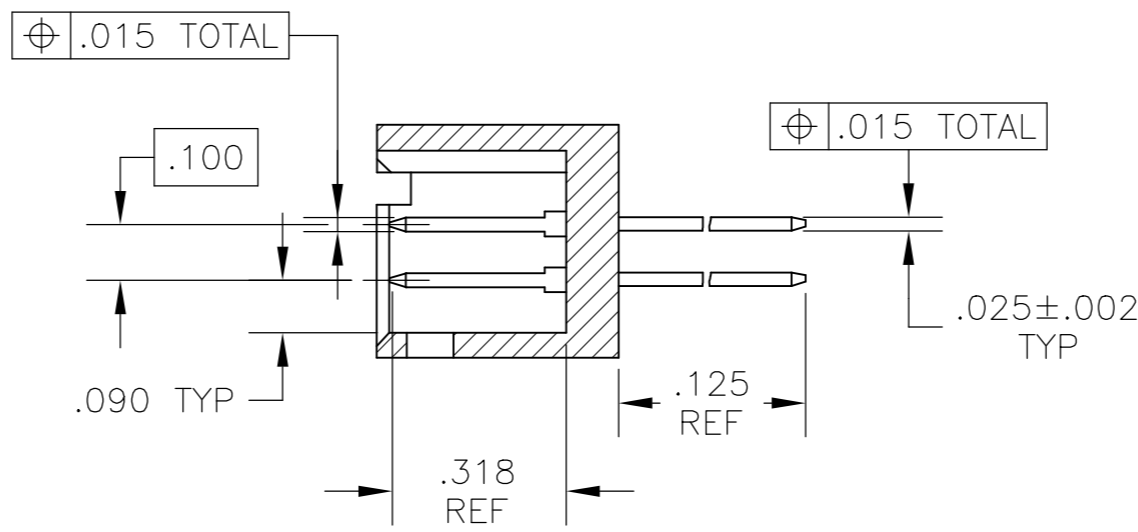
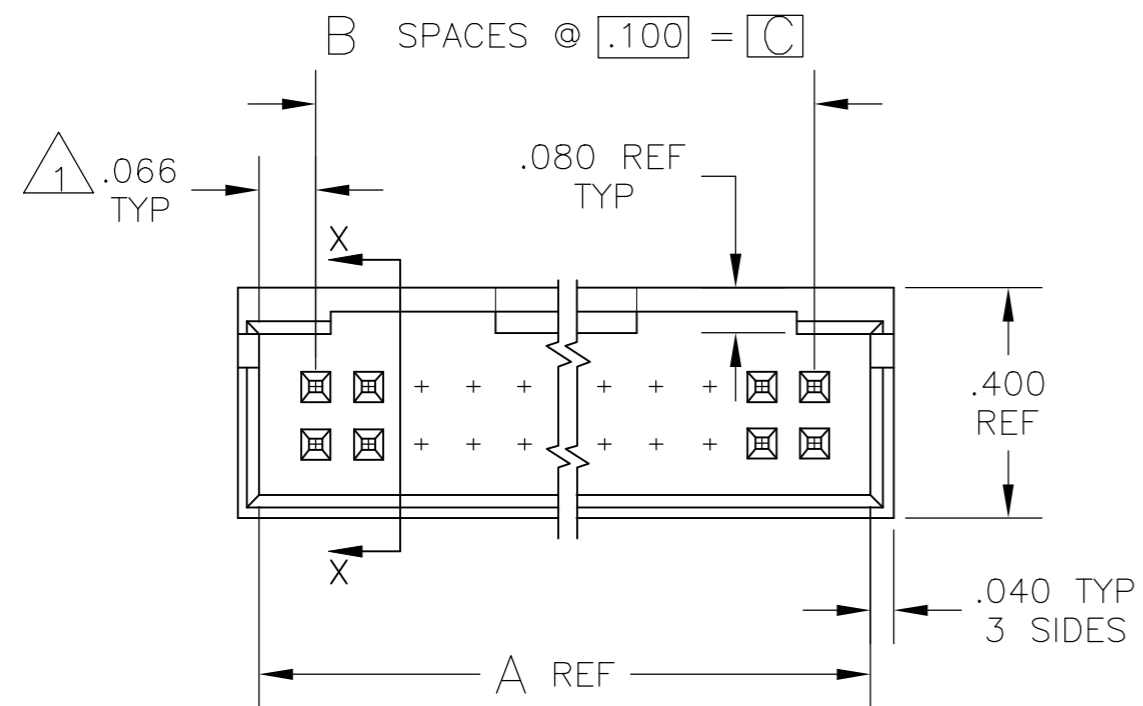

RECOMMENDED HOLE LAYOUT

THIS DRAWING IS A CONTROLLED DOCUMENT.		DWN	12 SEP 75		TE Connectivity			
DIMENSIONS: INCHES		CHK	12 SEP 75		NAME			
		APVD	15 SEP 75		HEADER ASSEMBLY MOD II, $.100$ C/L $.025$ SQUARE POST, WITH DETENT			
MATERIAL: HSG: GLASS FILLED NYLON, COLOR: BLACK, CONTACT: PHOS BRONZE		TOLERANCES UNLESS OTHERWISE SPECIFIED:		PRODUCT SPEC	SIZE	CAGE CODE	DRAWING NO	RESTRICTED TO
SEE TABLE		FINISH		APPLICATION SPEC	A2	00779	C=87589	
CUSTOMER DRAWING				WEIGHT	SCALE	SHEET	REV	
					3:1	1 of 2	R4	

THIS DRAWING IS UNPUBLISHED. RELEASED FOR PUBLICATION
 © COPYRIGHT - By - ALL RIGHTS RESERVED.

REVISIONS					
P	LTR	DESCRIPTION	DATE	DWN	APVD
-	-	SEE SHEET 1	-	-	-

D

C

B

A

-	.106	.200	2	.332	6	8-87589-6	
-	.106	.300	3	.432	8	8-87589-5	
3.506	.106	3.600	36	3.732	74	8-87589-3	
3.406	.106	3.500	35	3.632	72	8-87589-2	
3.306	.106	3.400	34	3.532	70	8-87589-1	
3.206	.106	3.300	33	3.432	68	8-87589-0	
3.106	.106	3.200	32	3.332	66	7-87589-9	
3.006	.106	3.100	31	3.232	64	7-87589-8	
2.906	.106	3.000	30	3.132	62	7-87589-7	
2.806	.106	2.900	29	3.032	60	7-87589-6	
2.706	.106	2.800	28	2.932	58	7-87589-5	
2.606	.106	2.700	27	2.832	56	7-87589-4	
2.506	.106	2.600	26	2.732	54	7-87589-3	
2.406	.106	2.500	25	2.632	52	7-87589-2	
2.306	.106	2.400	24	2.532	50	7-87589-1	
2.206	.106	2.300	23	2.432	48	7-87589-0	
2.106	.106	2.200	22	2.332	46	6-87589-9	
2.006	.106	2.100	21	2.232	44	6-87589-8	
1.906	.106	2.000	20	2.132	42	6-87589-7	
1.806	.106	1.900	19	2.032	40	6-87589-6	
1.706	.106	1.800	18	1.932	38	6-87589-5	
1.606	.106	1.700	17	1.832	36	6-87589-4	
1.506	.106	1.600	16	1.732	34	6-87589-3	
1.406	.106	1.500	15	1.632	32	6-87589-2	
1.306	.106	1.400	14	1.532	30	6-87589-1	
1.206	.106	1.300	13	1.432	28	6-87589-0	
1.106	.106	1.200	12	1.332	26	5-87589-9	
1.006	.106	1.100	11	1.232	24	5-87589-8	
.906	.106	1.000	10	1.132	22	5-87589-7	
.806	.106	.900	9	1.032	20	5-87589-6	
-	.406	.800	8	.932	18	5-87589-5	
-	.306	.700	7	.832	16	5-87589-4	
-	.306	.600	6	.732	14	5-87589-3	
-	.206	.500	5	.632	12	5-87589-2	
-	.206	.400	4	.532	10	5-87589-1	
FINISH	E	D	C	B	A	NO OF POSN.	PART NO.

 OBSOLETE

 OBSOLETE

 OBSOLETE

 OBSOLETE

 OBSOLETE

 OBSOLETE



 OBSOLETE

 OBSOLETE

 OBSOLETE

 OBSOLETE

 OBSOLETE

 OBSOLETE



SUPERCEDED BY 6-87589-4







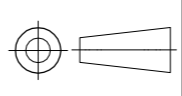

1.306	.106	1.400	14	1.532	30	3-87589-9	
-	.406	.800	8	.932	18	3-87589-8	
-	.306	.700	7	.832	16	3-87589-7	
-	.106	.200	2	.332	6	3-87589-6	
-	.106	.300	3	.432	8	3-87589-5	
3.506	.106	3.600	36	3.732	74	3-87589-3	
3.406	.106	3.500	35	3.632	72	3-87589-2	
3.306	.106	3.400	34	3.532	70	3-87589-1	
3.206	.106	3.300	33	3.432	68	3-87589-0	
3.106	.106	3.200	32	3.332	66	2-87589-9	
3.006	.106	3.100	31	3.232	64	2-87589-8	
2.906	.106	3.000	30	3.132	62	2-87589-7	
2.806	.106	2.900	29	3.032	60	2-87589-6	
2.706	.106	2.800	28	2.932	58	2-87589-5	
2.606	.106	2.700	27	2.832	56	2-87589-4	
2.506	.106	2.600	26	2.732	54	2-87589-3	
2.406	.106	2.500	25	2.632	52	2-87589-2	
2.306	.106	2.400	24	2.532	50	2-87589-1	
2.206	.106	2.300	23	2.432	48	2-87589-0	
2.106	.106	2.200	22	2.332	46	1-87589-9	
2.006	.106	2.100	21	2.232	44	1-87589-8	
1.906	.106	2.000	20	2.132	42	1-87589-7	
1.806	.106	1.900	19	2.032	40	1-87589-6	
1.706	.106	1.800	18	1.932	38	1-87589-5	
1.606	.106	1.700	17	1.832	36	1-87589-4	
1.506	.106	1.600	16	1.732	34	1-87589-3	
1.406	.106	1.500	15	1.632	32	1-87589-2	
1.306	.106	1.400	14	1.532	30	1-87589-1	
1.206	.106	1.300	13	1.432	28	1-87589-0	
1.106	.106	1.200	12	1.332	26	87589-9	
1.006	.106	1.100	11	1.232	24	87589-8	
.906	.106	1.000	10	1.132	22	87589-7	
.806	.106	.900	9	1.032	20	87589-6	
-	.406	.800	8	.932	18	87589-5	
-	.306	.700	7	.832	16	87589-4	
-	.306	.600	6	.732	14	87589-3	
-	.206	.500	5	.632	12	87589-2	
-	.206	.400	4	.532	10	87589-1	
FINISH	E	D	C	B	A	NO OF POSN.	PART NO.

THIS DRAWING IS A CONTROLLED DOCUMENT.		DWN	12 SEP 75	 TE Connectivity			
DIMENSIONS: INCHES		CHK	12 SEP 75				
TOLERANCES UNLESS OTHERWISE SPECIFIED:		APVD	15 SEP 75	NAME			
 0 PLC ± - 1 PLC ± - 2 PLC ± - 3 PLC ± .005 4 PLC ± - ANGLES ± -		PRODUCT SPEC		HEADER ASSEMBLY MOD II, .100 C/L .025 SQUARE POST, WITH DETENT			
MATERIAL: HSG: GLASS FILLED NYLON, COLOR: BLACK, CONTACT: PHOS BRONZE		APPLICATION SPEC		SIZE	CAGE CODE	DRAWING NO	RESTRICTED TO
SEE TABLE		WEIGHT		A2	00779	C=87589	-
CUSTOMER DRAWING				SCALE	1:1	SHEET	2 of 2
				REV R4			

X-ON Electronics

Largest Supplier of Electrical and Electronic Components

Click to view similar products for [Headers & Wire Housings](#) category:

Click to view products by [TE Connectivity](#) manufacturer:

Other Similar products are found below :

[892-18-020-10-001101](#) [58102-G61-06LF](#) [582553-1](#) [0009485154](#) [009176003701906](#) [0050291907](#) [LY20-4P-DT1-P1E-BR](#) [02.125.8002.8](#)
[609-3404](#) [61062-3](#) [61082-181009](#) [622-3653LF](#) [63453-116](#) [636-1030](#) [636-1427](#) [636-3427](#) [636-4007](#) [641938-9](#) [641991-4](#) [644827-2](#) [65817-](#)
[010LF](#) [65817-015LF](#) [65863-015LF](#) [66207-023LF](#) [67095-007LF](#) [67601157](#) [68645-018](#) [68648-049](#) [70.362.1628.0](#) [70-4210](#) [70-4226B](#) [70-](#)
[4853B](#) [707-5020](#) [707-5028](#) [71.350.2428.0](#) [71918-208LF](#) [71961-016LF](#) [733-134](#) [733-162](#) [754199-000](#) [760-3052](#) [79531-3000](#) [FCN-](#)
[360C032-B](#) [FCN-367T-T012/H](#) [FCN-723D010/2](#) [80.063.4001.1](#) [800-90-010-10-002000](#) [801-43-002-10-013000](#) [801-43-006-10-002000](#)
[801-93-011-10-001000](#)