

91093-1 ✓ ACTIVE

AMP | MQS

TE Internal #: 91093-1

MQS, Insertion & Extraction Tools, Contact Extraction, Contact-to-Housing

[View on TE.com >](#)



Application Tooling > Insertion & Extraction Tools

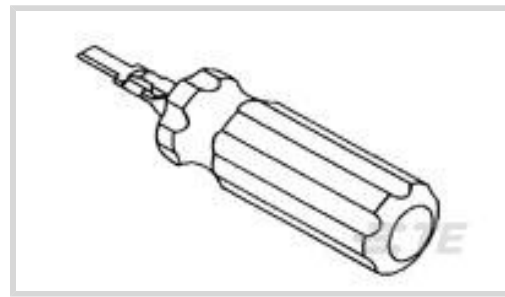

Insertion & Extraction Tool Type: **Contact Extraction**

Insertion & Extraction Tool Application: **Contact-to-Housing**

Features

Product Type Features

Insertion & Extraction Tool Type	Contact Extraction
Insertion & Extraction Tool Application	Contact-to-Housing

Product Compliance

[For compliance documentation, visit the product page on TE.com>](#)

EU RoHS Directive 2011/65/EU	Compliant
EU ELV Directive 2000/53/EC	Out of Scope
China RoHS 2 Directive MIIT Order No 32, 2016	No Restricted Materials Above Threshold
EU REACH Regulation (EC) No. 1907/2006	Current ECHA Candidate List: JAN 2021 (211) Candidate List Declared Against: JAN 2021 (211) Does not contain REACH SVHC
Halogen Content	Low Halogen - Br, Cl, F, I < 900 ppm per homogenous material. Also BFR/CFR/PVC Free
Solder Process Capability	Not reviewed for solder process capability

Product Compliance Disclaimer

This information is provided based on reasonable inquiry of our suppliers and represents our current actual knowledge based on the information they provided. This information is subject to change. The part numbers that TE has identified as EU RoHS compliant have a maximum concentration of 0.1% by weight in homogenous materials for lead, hexavalent chromium, mercury, PBB, PBDE, DBP, BBP, DEHP, DIBP, and 0.01% for cadmium, or qualify for an exemption to these limits as defined in the Annexes of Directive 2011/65/EU (RoHS2). Finished electrical and electronic equipment products will be CE marked as required by Directive 2011/65/EU. Components may not be CE marked. Additionally, the part numbers that TE has identified as EU ELV compliant have a maximum concentration of 0.1% by weight in homogenous materials for lead, hexavalent chromium, and mercury, and 0.01% for cadmium, or qualify for an exemption to these limits as defined in the Annexes of Directive 2000/53/EC (ELV). Regarding the REACH Regulation, the information TE provides on SVHC in articles for this part number is based on the latest European Chemicals Agency (ECHA) 'Guidance on

requirements for substances in articles' posted at this URL: <https://echa.europa.eu/guidance-documents/guidance-on-reach>

Compatible Parts



TE Part # CAT-M8793-T273
MQS, RECEPTACLE AND TAB



TE Part # 1452128-2
MQS PIN CONTACT FFC



TE Part # 1452128-3
MQS ST-KONT M.FFC

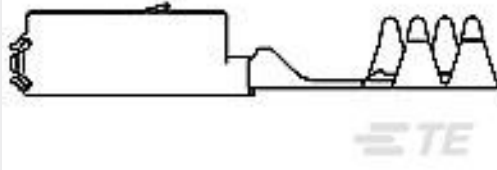

TE Part # 929388-1
MQS SOCKET CONTACT



TE Part # 1452129-1
MQS PIN CONTACT FFC

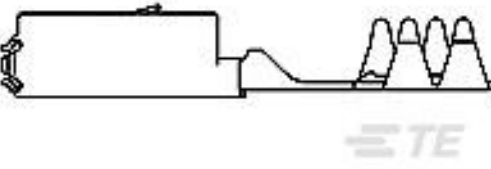

TE Part # 968988-1
MQS BU M.FFC-CRIMP

Also in the Series | MQS



Automotive Connector Caps & Covers (133)

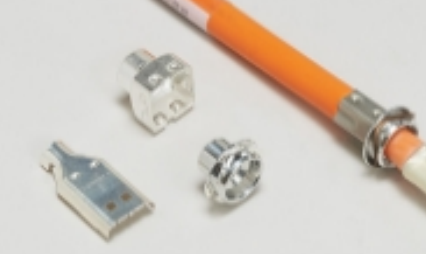

Automotive Connector EMC Shielding (2)

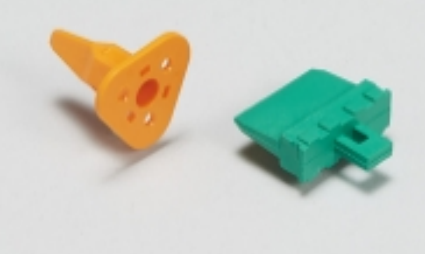

Automotive Connector Locks & Position Assurance(29)



Automotive Headers(207)



Automotive Housings(498)



Automotive Seals & Cavity Plugs(26)



Automotive Terminals(98)



Data Connectivity Headers(1)



Insertion & Extraction Tools(42)



Other Automotive Connector Accessories(13)

Customers Also Bought



TE Part #284858-4
12 POS MALE HOUSING ASS'Y



TE Part #928876-1
JUN-POW-TIM KONT



TE Part #2282150-1
2POS,NANOMQS,REC HSG,CODA



TE Part #3-1768017-0
EET-0517P-4



TE Part #1-1633738-5
CRIMPER, WIRE F .058



TE Part #2150234-1
OCEAN_2.0_APPLICATIONER-E-110F180F



TE Part #2151266-1
OCEAN-2.0-APPLICATIONER-S-070F080BX



TE Part #2836860-2
OCEAN_2.0_APPLICATIONER-S-110F180F



TE Part #3-1803001-6
ANVIL, COMBINATION, END FEED



TE Part #364306-000
RMW-75/22-1000/ADH-0

Documents

Datasheets & Catalog Pages

[Crimp Term Whitepaper-Use the Right Tool 1-1773953-1](#)

English

[CRIMPING WHERE FORM MEETS FUNCTION](#)

English

[Insertion-Extraction-Tool-2345721-1](#)

English



Instruction Sheets

[Instruction Sheet \(U.S.\)](#)

English

[Extraction Tool for Flexible Flat Cable \(FFC\)](#)

English

X-ON Electronics

Largest Supplier of Electrical and Electronic Components

Click to view similar products for [Extraction, Removal & Insertion Tools](#) category:

Click to view products by [TE Connectivity](#) manufacturer:

Other Similar products are found below :

[M8196914-08](#) [768211-2](#) [809-131](#) [844751-2](#) [8-59558-2](#) [91018-1](#) [12014013](#) [12093647](#) [1-21048-0](#) [R282867020](#) [12093078](#) [1-21048-6](#)
[12121897](#) [DCF.91.405.5LT](#) [1322](#) [15314260](#) [15350698](#) [15350707](#) [15430130](#) [1579018-4](#) [1643916-1](#) [1-679532-0](#) [1976593-3](#) [OUTEXT-0321](#)
[2-1579008-3](#) [2-1579008-4](#) [229694-7](#) [231106-1](#) [241469](#) [91040-3](#) [91040-7](#) [965004-000](#) [965069-000](#) [1738219-1](#) [ET-JL05-16](#) [FG 0300 146](#)
[3000](#) [FIT-6](#) [210S048](#) [2-1579007-9](#) [231879-1](#) [312138-3](#) [RJ11FODE](#) [356-162](#) [M8196914-10](#) [4-1579018-0](#) [430395-001](#) [483249-1](#) [5-](#)
[1579007-2](#) [5-1579007-9](#) [BPR10](#)