

LOC	DIST	REVISIONS					
		P	LTM	DESCRIPTION	DATE	DWN	APVD
		A9		ECR-16-012681	05SEP2016	WW	RR
		A10		ECR-17-001797	16FEB2017	LZ	RR
		A11		ECR-17-009226	03JUL2017	LZ	RR
		B		ECR-21-100879	30MAR2021	KD	FL

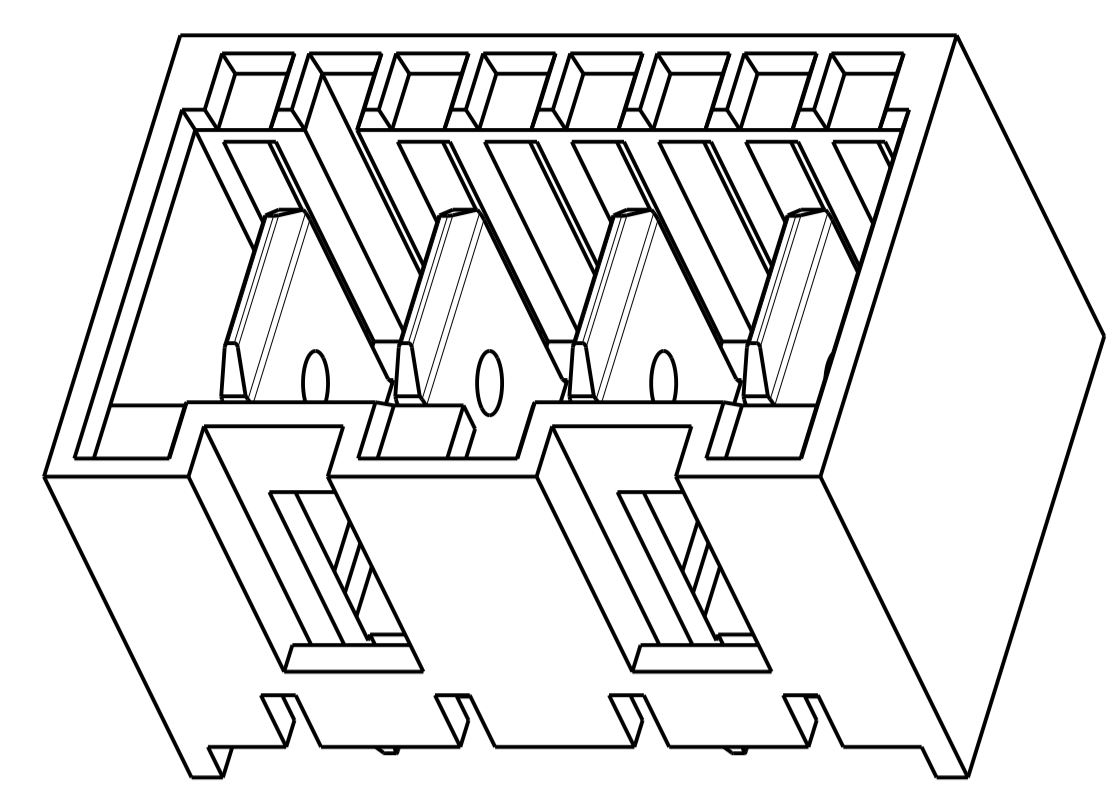

- NOTE**
- HOUSING HAS RAST 5 COMPLIANT KEYING, LATCHING, AND POLARIZATION TAB IS 6.30 X 0.8 ACCORDING TO DIN 46244
  - SEE SHEET 2 FOR AVAILABLE CONFIGURATIONS
  - MATERIAL: HOUSING, NYLON, UL94 V0, 750°C GWT NO FLAME CONTACT, COPPER ALLOY, 0.8MM THICK
  - FINISH: CONTACTS, MATT TIN PLATING OVERALL, NICKEL UNDER-PLATING BRIGHT TIN PLATING OVERALL, NICKEL UNDER-PLATING SILVER PLATING OVERALL, NICKEL UNDER-PLATING
  - PCB TABS INSERTED IN A STAGGERED PATTERN BEGINNING WITH POSITION 1 (Cct1)
  - THE PART NUMBERS SHOWING IN SHEET 2 & 3 & 4 & 5 ARE FOR NATURAL COLOR. THE PART NUMBER FOR OTHER COLOR ARE BASED ON THE NATURAL ONE: FOR THE SAME CONFIGURATION, THE PREFIX AND POSTFIX OF THE P/N ARE THE SAME, ONLY THE BASE NUMBER IS DIFFERENT ACCORDING TO DIFFERENT COLOR, DETAIL PLEASE SEE SHEET 6
  - PACKAGING: LOOSE PIECE OR TUBE. THE PART NUMBERS IN THIS DRAWING ARE WITH LOOSE PIECE PACKAGING. PLEASE CONTACT TE SALES REPRESENTATIVES FOR TUBE PACKAGING REQUIREMENT.
- ⚠ PRELIMINARY PART NOT RELEASED FOR PRODUCTION
  - ⚠ FOR P/N: 8-2232043-7:  
1) THE CONTACTS ARE WITH BRIGHT TIN PLATING ACCORDING TO STANDARD: ASTM B 545.

- ⚠ PART NUMBERS WITH TUBE PACKAGING
- ⚠ PART WITHOUT POLARIZATION PEG STRUCTURE (FOR PN: 2316476-3)

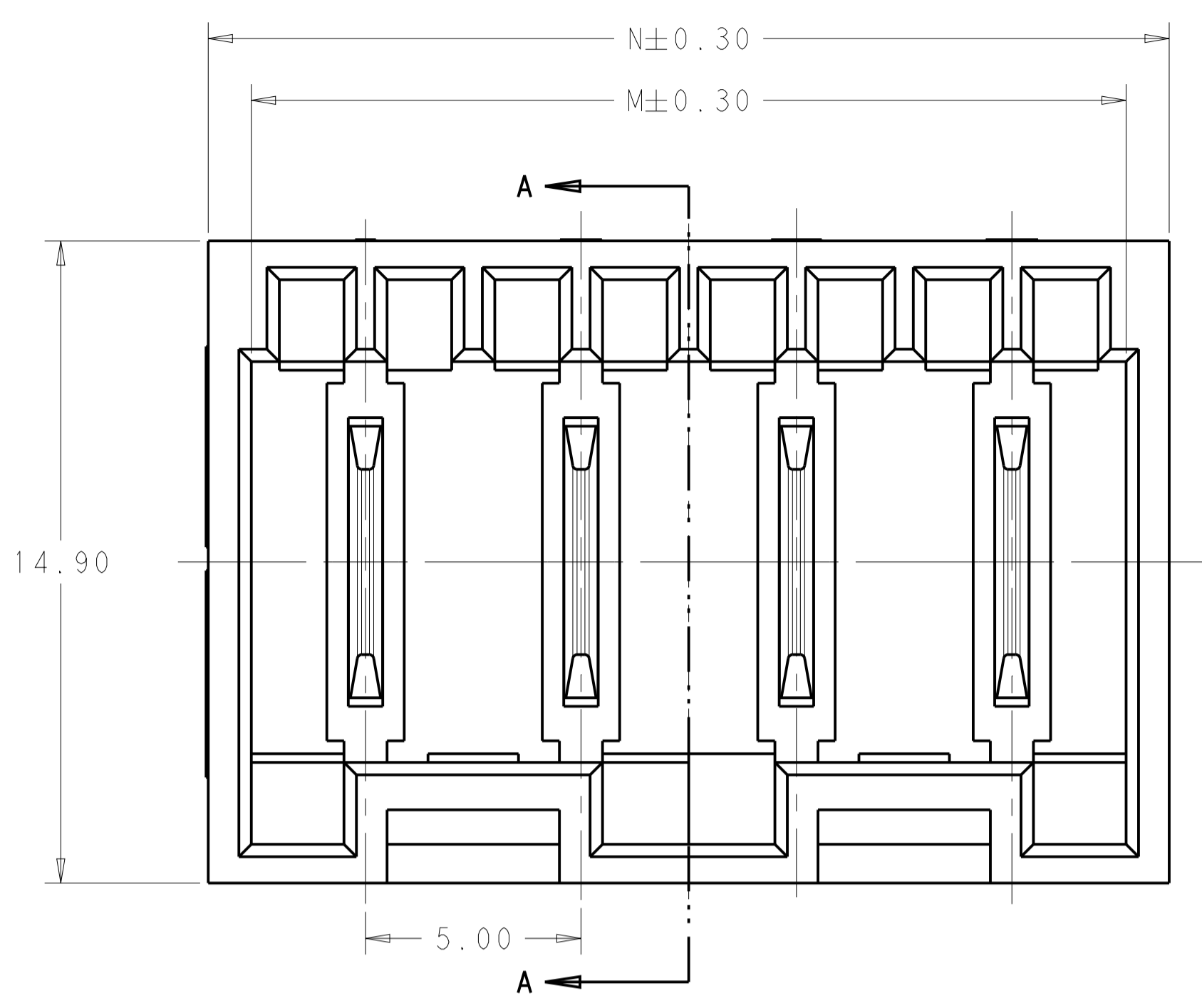
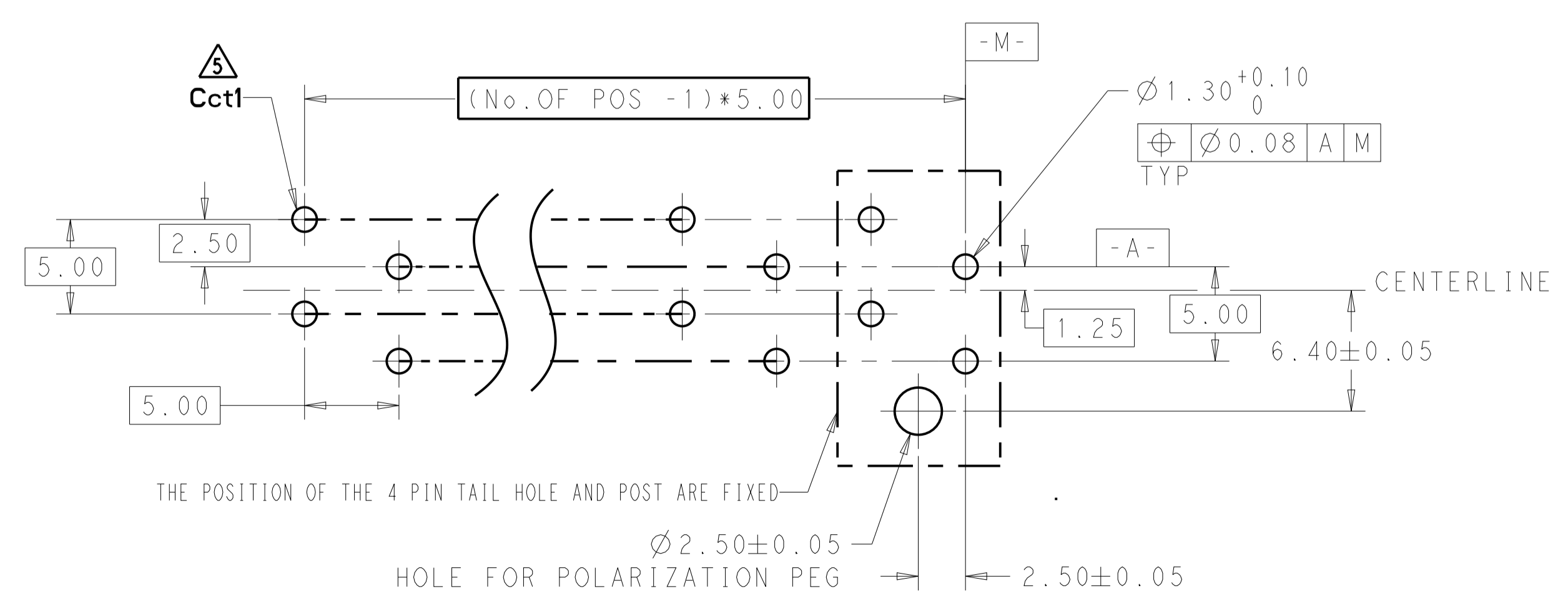
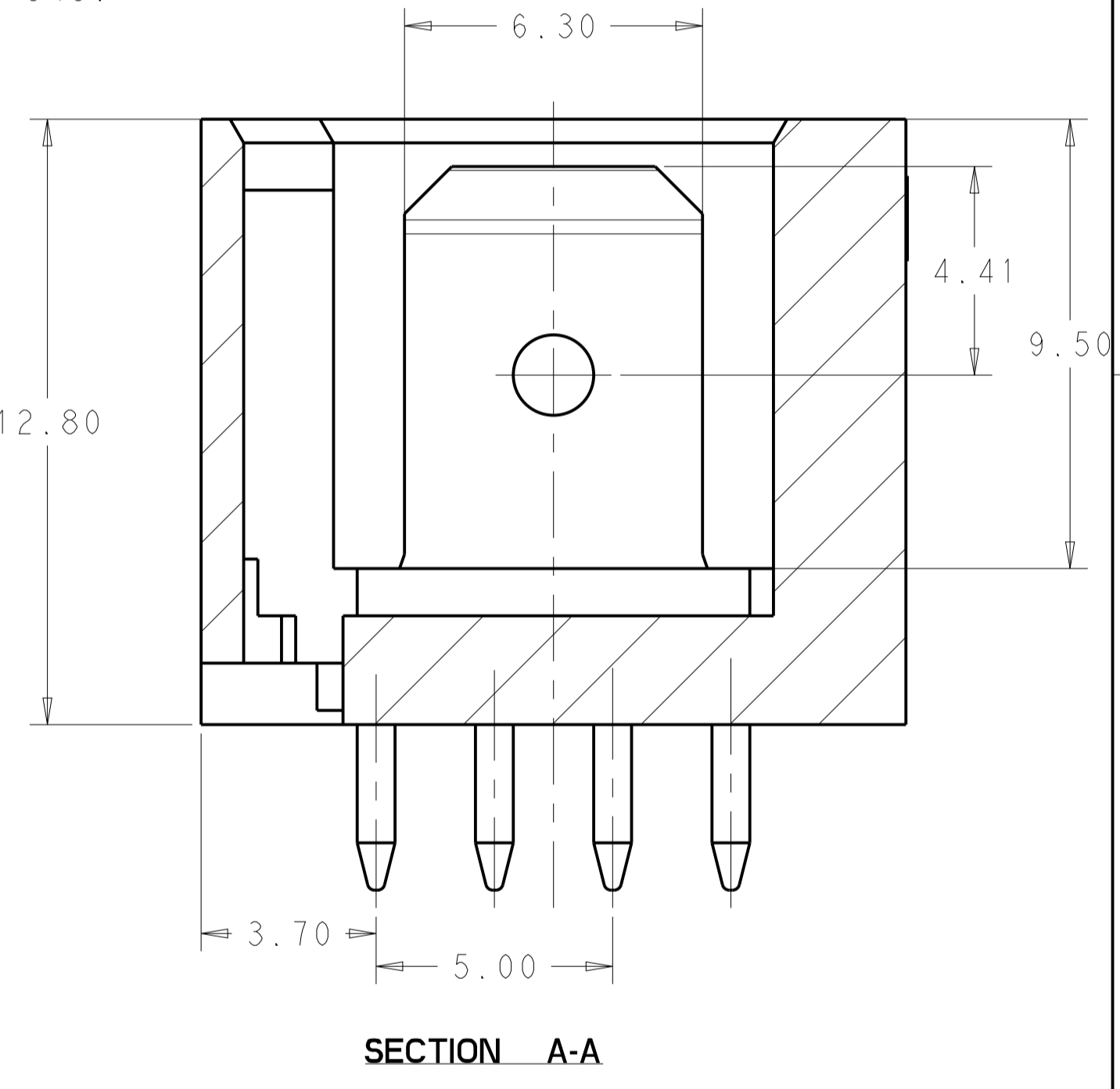
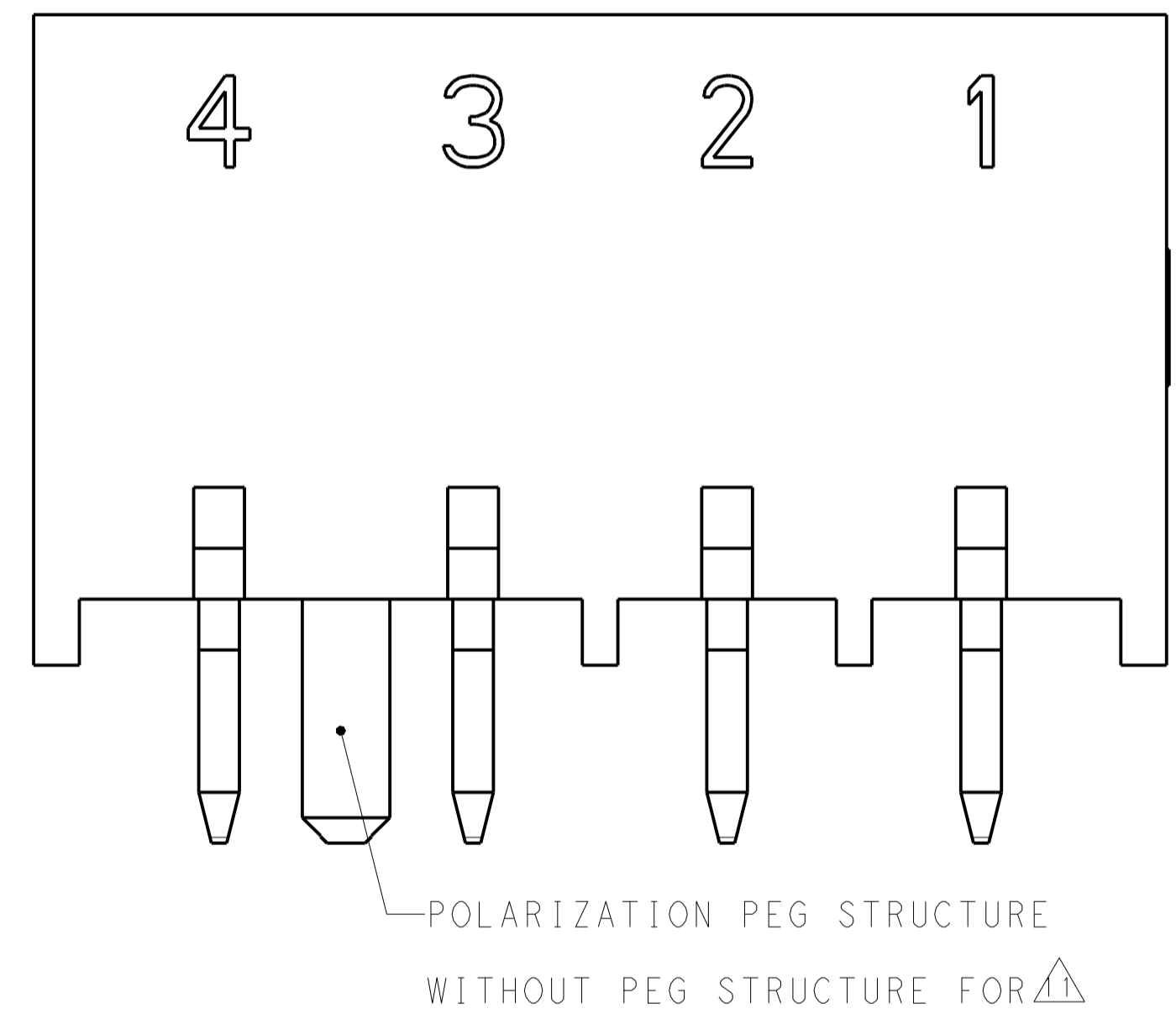
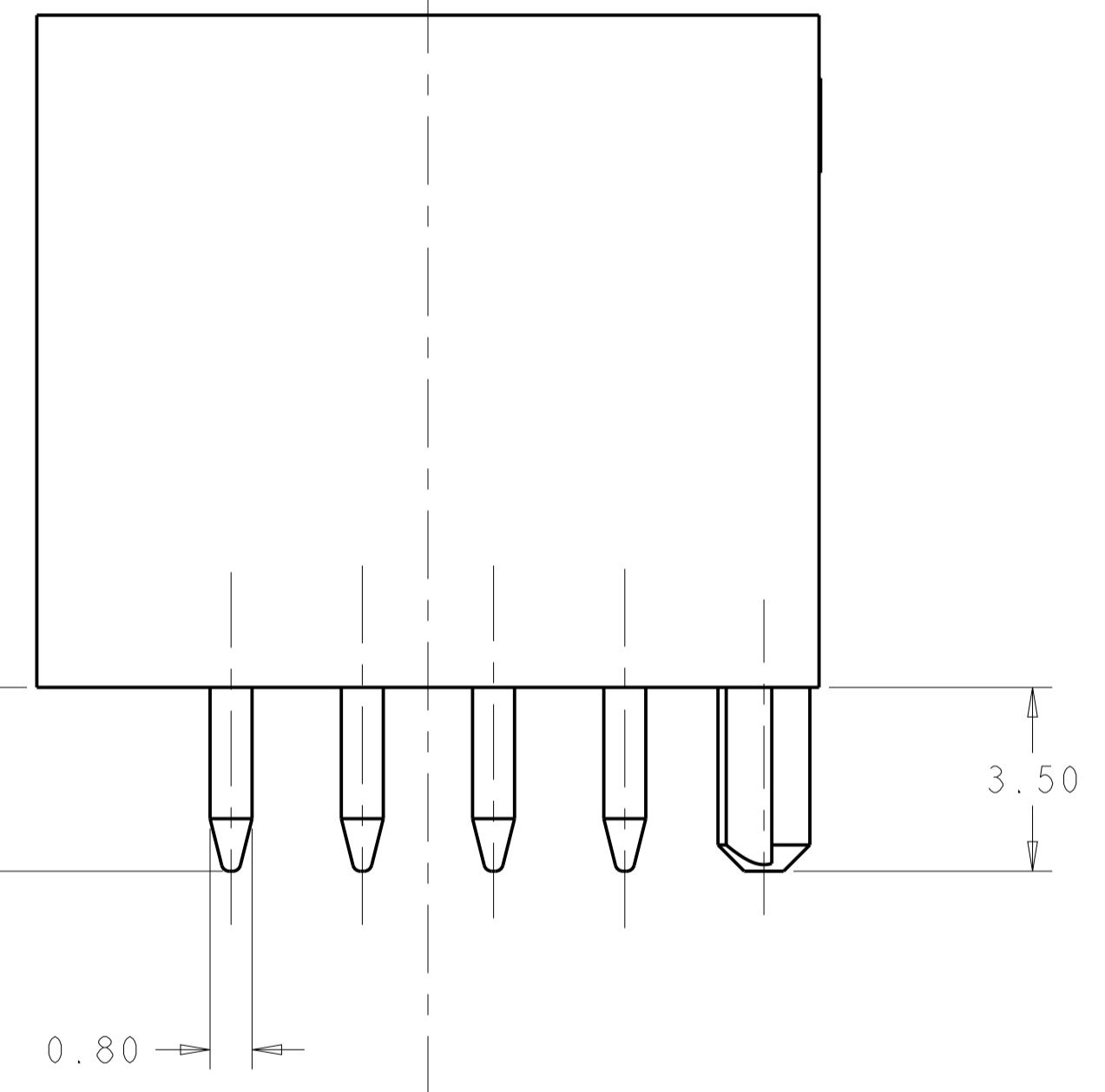
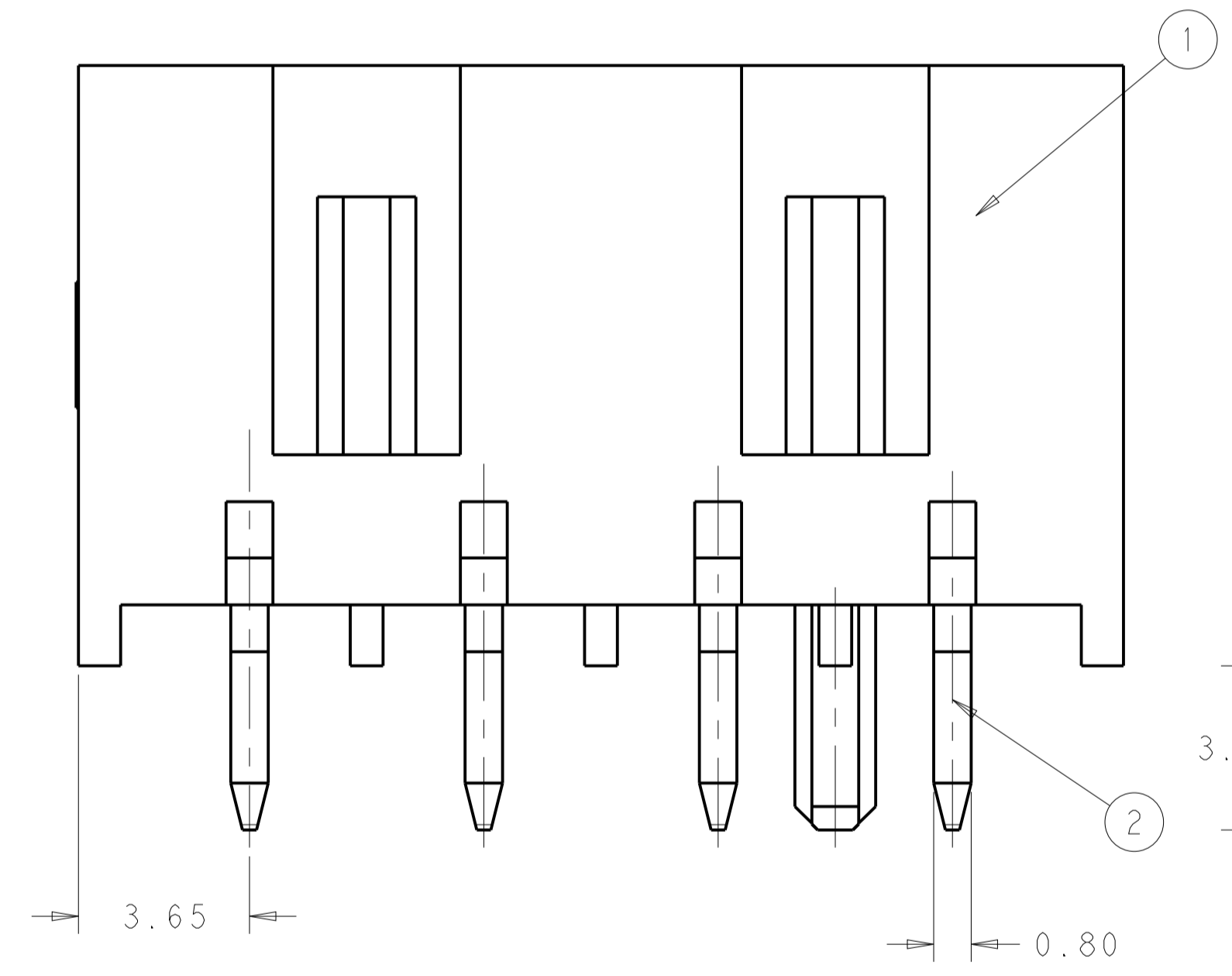

**RECOMMEND PCB LAYOUT - SOLDER SIDE**  
 EVEN NUMBER OF PINS  
 PCB 15±0.2 THICK

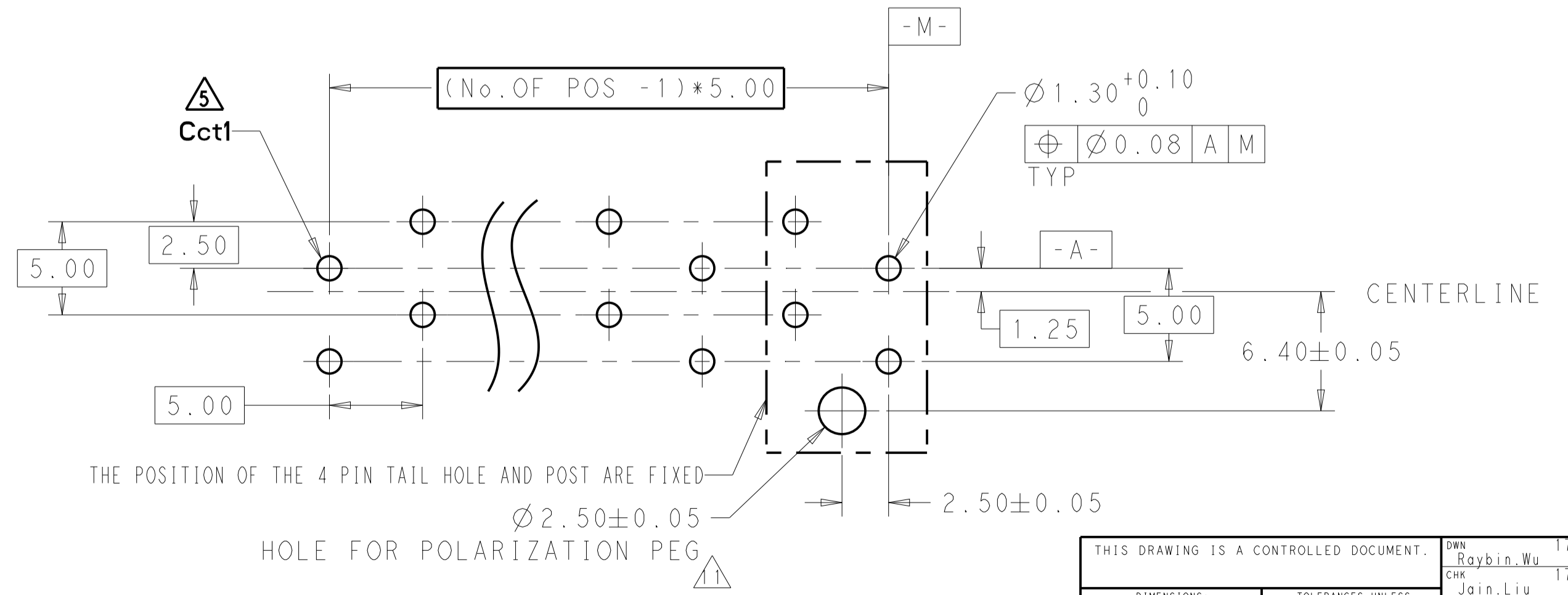

**RECOMMEND PCB LAYOUT - SOLDER SIDE**  
 ODD NUMBER OF PINS  
 PCB 15±0.2 THICK

42.30	40.30	8
37.30	35.30	7
32.30	30.30	6
27.30	25.30	5
22.30	20.30	4
17.30	15.30	3
12.30	10.30	2
N	M	NO. OF POS.

THIS DRAWING IS A CONTROLLED DOCUMENT.

OWN: Raybin.Wu 17Mar2014  
 CHK: Jain.Liu 17Mar2014  
 APVD: Robone.Riccardi 17Mar2014

TE Connectivity

NAME: RAST 5 TAB HEADER ASSY, OPPOSITE DIN STYLE, TH, VERTICAL

PRODUCT SPEC: 108-106080  
 APPLICATION SPEC: -

SIZE: A1  
 CAGE CODE: 2232043  
 DRAWING NO: 8-2232043-7

RESTRICTED TO: -

Customer Drawing

SCALE: 5:1 SHEET 1 OF 6 REV B

LOC	DIST	REV	DATE	BY	APPV
ES	00				

QTY	②	QTY	①	NO. OF POS.	TE PART NO.
8	TAB CONTACT MATT TIN PLATING (8-2232043-7 IS WITH BRIGHT TIN)	1	RAST 5 TAB HEADER HOUSING, 8P, NATURE (SEE THE DETAIL LAYOUT ON SHEET 5)	8	5-2232043-8
4-2232043-8					
3-2232043-8					
2-2232043-8					
1-2232043-8					
2232043-8					
9-2232043-7					
8-2232043-7					
7-2232043-7					
6-2232043-7					
5-2232043-7					
4-2232043-7					
3-2232043-7					
2-2232043-7					
1-2232043-7					
2232043-7					
7	TAB CONTACT MATT TIN PLATING (8-2232043-7 IS WITH BRIGHT TIN)	1	RAST 5 TAB HEADER HOUSING, 7P, NATURE (SEE THE DETAIL LAYOUT ON SHEET 5)	7	2232045-6
9-2232043-6					
8-2232043-6					
7-2232043-6					
6-2232043-6					
5-2232043-6					
4-2232043-6					
3-2232043-6					
2-2232043-6					
1-2232043-6					
2232043-6					
2232512-5					
9-2232043-5					
8-2232043-5					
7-2232043-5					
6-2232043-5					
5-2232043-5					
4-2232043-5					
3-2232043-5					
2-2232043-5					
1-2232043-5					
2232043-5					
6	TAB CONTACT MATT TIN PLATING (8-2232043-7 IS WITH BRIGHT TIN)	1	RAST 5 TAB HEADER HOUSING, 6P, NATURE (SEE THE DETAIL LAYOUT ON SHEET 5)	6	5-2232043-5
4-2232043-5					
3-2232043-5					
2-2232043-5					
1-2232043-5					
2232043-5					
9-2232043-4					
8-2232043-4					
7-2232043-4					
6-2232043-4					
5-2232043-4					
4-2232043-4					
3-2232043-4					
2-2232043-4					
1-2232043-4					
2232043-4					
5	TAB CONTACT MATT TIN PLATING (8-2232043-7 IS WITH BRIGHT TIN)	1	RAST 5 TAB HEADER HOUSING, 5P, NATURE (SEE THE DETAIL LAYOUT ON SHEET 4)	5	5-2232043-4
4-2232043-4					
3-2232043-4					
2-2232043-4					
1-2232043-4					
2232043-4					
9-2232043-3					
8-2232043-3					
7-2232043-3					
6-2232043-3					
5-2232043-3					
4-2232043-3					
3-2232043-3					
2-2232043-3					
1-2232043-3					
2303420-3					
2232043-3					

QTY	②	QTY	①	NO. OF POS.	TE PART NO.
4	TAB CONTACT MATT TIN PLATING	1	RAST 5 TAB HEADER HOUSING, 4P, NATURE (SEE THE DETAIL LAYOUT ON SHEET 4)	4	5-2232045-4
4-2232045-4					
3-2232045-4					
2-2232045-4					
2232045-4					
9-2232043-4					
8-2232043-4					
7-2232043-4					
6-2232043-4					
5-2232043-4					
4-2232043-4					
3-2232043-4					
2-2232043-4					
1-2232043-4					
2303420-4					
2232043-4					
3	TAB CONTACT MATT TIN PLATING	1	RAST 5 TAB HEADER HOUSING, 3P, NATURE (SEE THE DETAIL LAYOUT ON SHEET 4)	3	5-2232045-3
4-2232045-3					
3-2232045-3					
2-2232045-3					
1-2232045-3					
2232045-3					
9-2232043-3					
8-2232043-3					
7-2232043-3					
6-2232043-3					
5-2232043-3					
4-2232043-3					
3-2232043-3					
2-2232043-3					
1-2232043-3					
2303420-3					
2232043-3					
2	TAB CONTACT MATT TIN PLATING	1	RAST 5 TAB HEADER HOUSING, 2P, NATURE (SEE THE DETAIL LAYOUT ON SHEET 4)	2	4-2232045-2
3-2232045-2					
2-2232045-2					
1-2232045-2					
2232045-2					
9-2232043-2					
8-2232043-2					
7-2232043-2					
6-2232043-2					
5-2232043-2					
4-2232043-2					
3-2232043-2					
2-2232043-2					
1-2232043-2					
2232043-2					

THIS DRAWING IS A CONTROLLED DOCUMENT.

DIMENSIONS: MEN 	TOLERANCES UNLESS OTHERWISE SPECIFIED: 0 PLC ± 1 PLC ±0.25 2 PLC ± 3 PLC ± 4 PLC ± ANGLES ±2° FINISH	CHECKED: HUIPING WU 30-Jan-13 DRAWN: HAPYE WU 30-Jan-13 APVD: YIM 30-Jan-13 PRODUCT SPEC APPLICATION SPEC WEIGHT CUSTOMER DRAWING	NAME: RAST 5 TAB HEADER ASSY, OPPOSITE DIN STYLE, TH, VERTICAL SIZE: A1 CAGE CODE: 00779 DRAWING NO: 2232043 SCALE: N/A SHEET: 2 OF 6 REV: B
------------------------	---	---	--

4805 (3/11)

LOC	DIST	REV	DATE	BY	APPV
ES	00				

REVISIONS			
NO.	DATE	DESCRIPTION	BY
-	-	SEE SHEET 1	-

3	TAB CONTACT W/SILVER PLATING	1	RAST 5 TAB HEADER HOUSING, 3P, NATURE (SEE THE DETAIL LAYOUT ON SHEET 4)	3	2316476-3
QTY	②	QTY	①	NO. OF POS.	TE PART NO.

8	TAB CONTACT w/ SILVER PLATING	1	RAST 5 TAB HEADER HOUSING, 8P, NATURE (SEE THE DETAIL LAYOUT ON SHEET 5)	8	5-2232044-8
					4-2232044-8
					3-2232044-8
					2-2232044-8
7	TAB CONTACT w/ SILVER PLATING	1	RAST 5 TAB HEADER HOUSING, 7P, NATURE (SEE THE DETAIL LAYOUT ON SHEET 5)	7	1-2232044-8
					2232044-8
					9-2232044-7
					8-2232044-7
					7-2232044-7
					6-2232044-7
					5-2232044-7
					4-2232044-7
6	TAB CONTACT w/ SILVER PLATING	1	RAST 5 TAB HEADER HOUSING, 6P, NATURE (SEE THE DETAIL LAYOUT ON SHEET 5)	6	3-2232044-7
					2-2232044-7
					1-2232044-7
					2232044-7
					9-2232044-6
					8-2232044-6
					7-2232044-6
					6-2232044-6
					5-2232044-6
					4-2232044-6
					3-2232044-6
					2-2232044-6
5	TAB CONTACT w/ SILVER PLATING	1	RAST 5 TAB HEADER HOUSING, 5P, NATURE (SEE THE DETAIL LAYOUT ON SHEET 4)	5	1-2232044-6
					2232044-6
					9-2232044-5
					8-2232044-5
					7-2232044-5
					6-2232044-5
					5-2232044-5
					4-2232044-5
					3-2232044-5
					2-2232044-5
					1-2232044-5
					2232044-5
QTY	②	QTY	①	NO. OF POS.	TE PART NO.

4	TAB CONTACT w/ SILVER PLATING	1	RAST 5 TAB HEADER HOUSING, 4P, NATURE (SEE THE DETAIL LAYOUT ON SHEET 4)	4	5-2232046-4
					4-2232046-4
					3-2232046-4
					2-2232046-4
					1-2232046-4
					2232046-4
					9-2232044-4
					8-2232044-4
					7-2232044-4
					6-2232044-4
					5-2232044-4
					4-2232044-4
3	TAB CONTACT w/ SILVER PLATING	1	RAST 5 TAB HEADER HOUSING, 3P, NATURE (SEE THE DETAIL LAYOUT ON SHEET 4)	3	3-2232044-4
					2-2232044-4
					1-2232044-4
					2232044-4
					4-2232046-3
					3-2232046-3
					2-2232046-3
					1-2232046-3
					2232046-3
					9-2232044-3
					8-2232044-3
					7-2232044-3
2	TAB CONTACT w/ SILVER PLATING	1	RAST 5 TAB HEADER HOUSING, 2P, NATURE (SEE THE DETAIL LAYOUT ON SHEET 4)	2	6-2232044-3
					5-2232044-3
					4-2232044-3
					3-2232044-3
					2-2232044-3
					1-2232044-3
					2232044-3
					4-2232046-2
					3-2232046-2
					2-2232046-2
					1-2232046-2
					2232046-2
9-2232044-2					
8-2232044-2					
7-2232044-2					
6-2232044-2					
5-2232044-2					
4-2232044-2					
3-2304587-2					
3-2232044-2					
2-2232044-2					
1-2232044-2					
2232044-2					
QTY	②	QTY	①	NO. OF POS.	TE PART NO.

THIS DRAWING IS A CONTROLLED DOCUMENT.

DIMENSIONS: MEN	TOLERANCES UNLESS OTHERWISE SPECIFIED:	0 PLC ±	1 PLC ±	2 PLC ±0.25	3 PLC ±	4 PLC ±	ANGLES ±	FINISH

OWN: EQUIPING, WU	CHK: HAPYE WU	30-Jan-13
APVD: YIM	30-Jan-13	
PRODUCT SPEC		
APPLICATION SPEC		
WEIGHT		
CUSTOMER DRAWING		

**ITE** TE Connectivity

NAME: RAST 5 TAB HEADER ASSY, OPPOSITE DIN STYLE, TH, VERTICAL

SIZE: A1 CAGE CODE: 00779 DRAWING NO: 2232043 RESTRICTED TO: -

SCALE: N/A SHEET 3 OF 6 REV B

LOC	DIST	REV	DATE	BY	APPV
ES	00				

  

REVISIONS				
REV	DATE	DESCRIPTION	BY	APPV
-	-	SEE SHEET 1	-	-

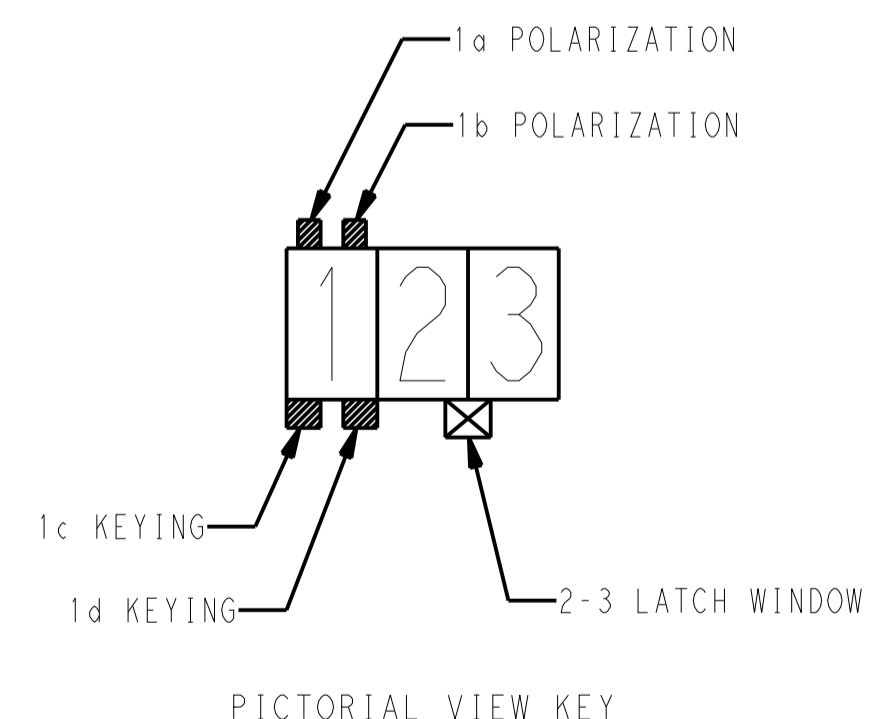

THIS DRAWING IS A CONTROLLED DOCUMENT.		OWN RUIPING WU 30-Jan-13		
DIMENSIONS:		CHK HAPYE WU 30-Jan-13		
TOLERANCES UNLESS OTHERWISE SPECIFIED:		APVD YIM 30-Jan-13	NAME RAST 5 TAB HEADER ASSY, OPPOSITE DIN STYLE, TH, VERTICAL	
MIN		PRODUCT SPEC	SIZE A1	
		APPLICATION SPEC	CAGE CODE 00779	
MATERIAL		FINISH	DRAWING NO 2232043	
		WEIGHT	RESTRICTED TO REV B	
		CUSTOMER DRAWING	SCALE N/A	
			SHEET 4 OF 6	

LOC	DIST	REV	DATE	BY	APPV	DESCRIPTION
ES	00					SEE SHEET 1

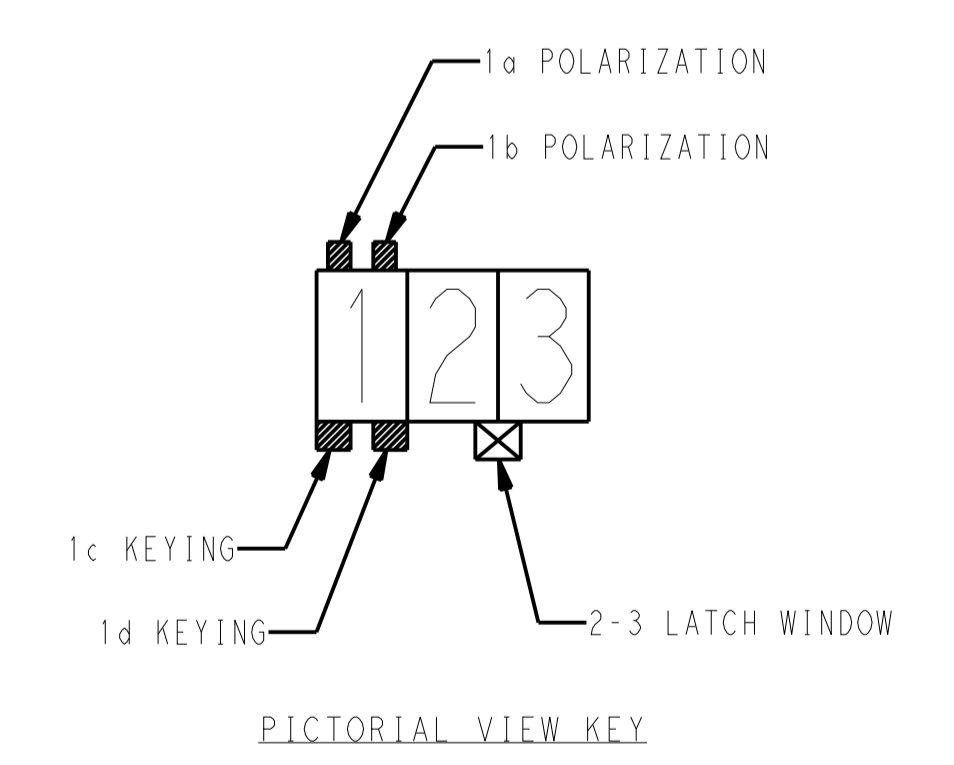
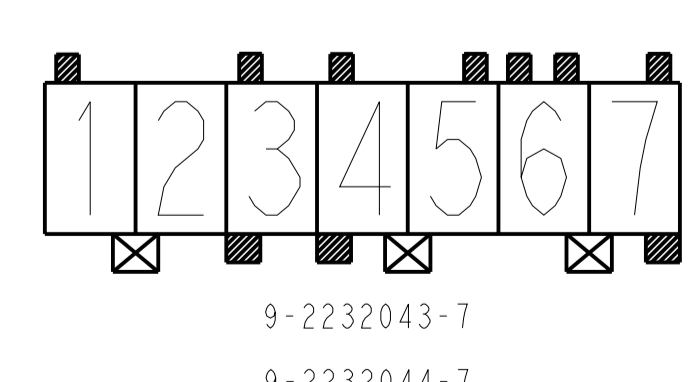
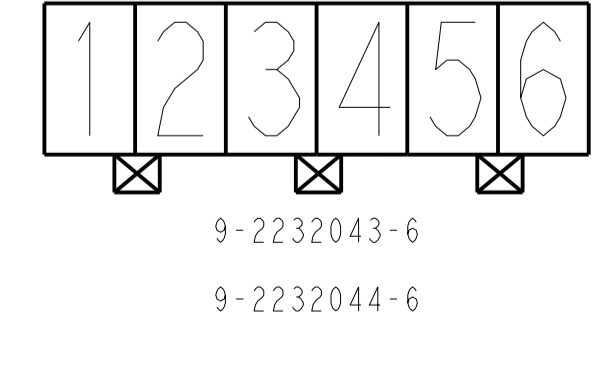
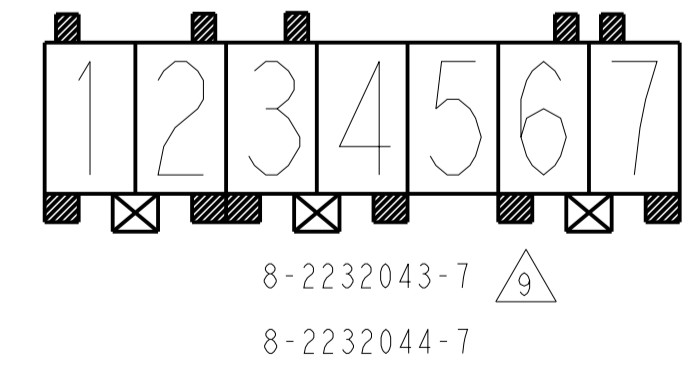
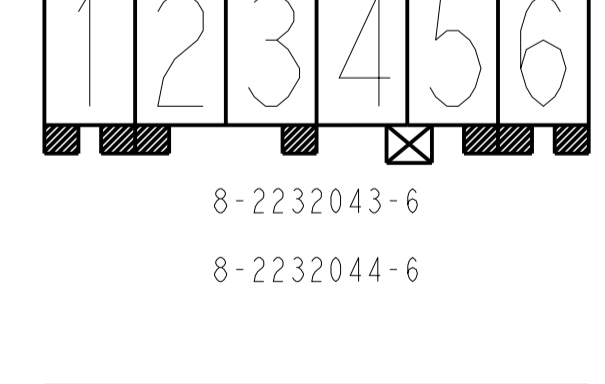
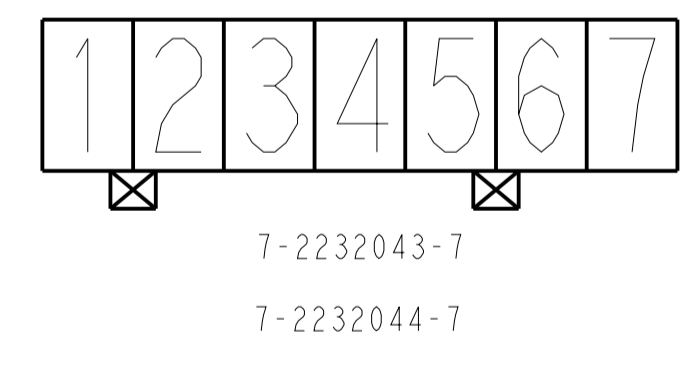
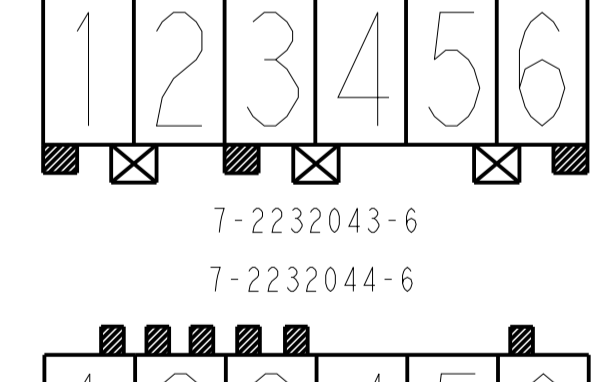
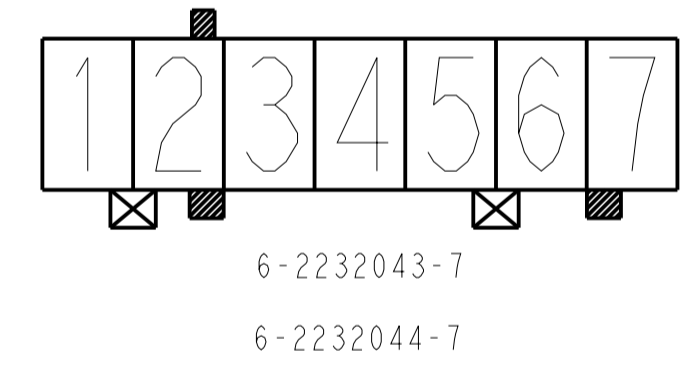
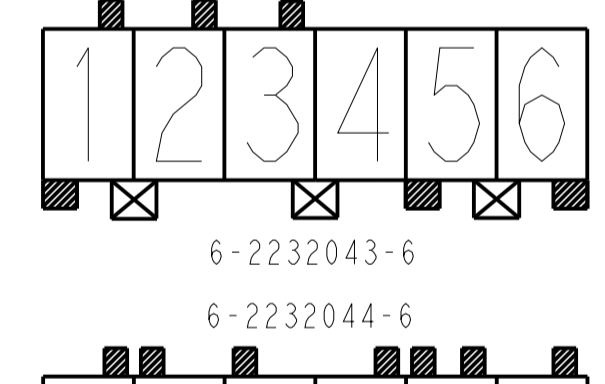
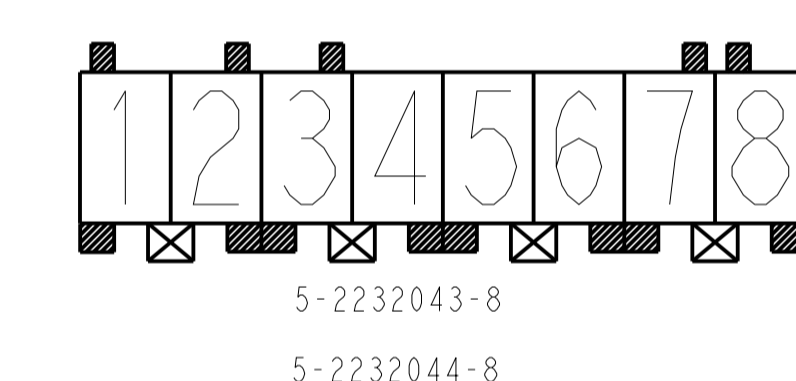
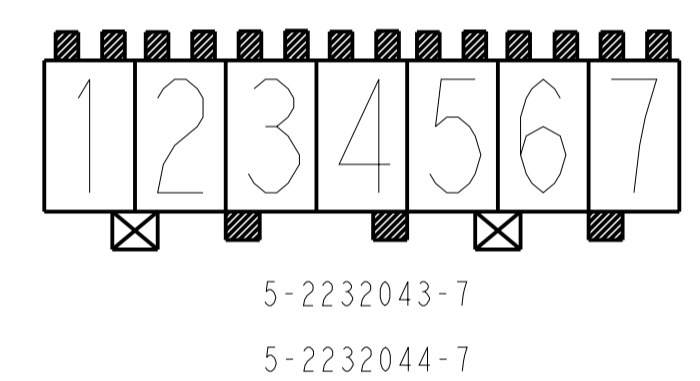
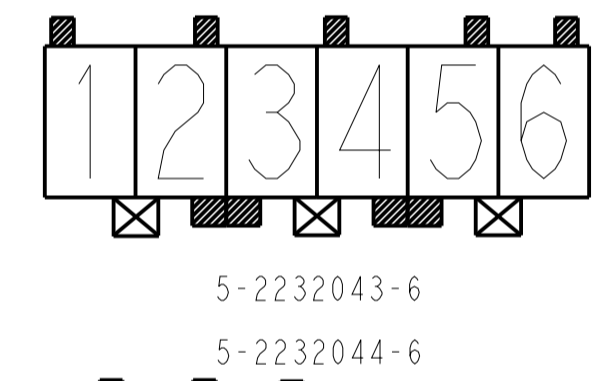
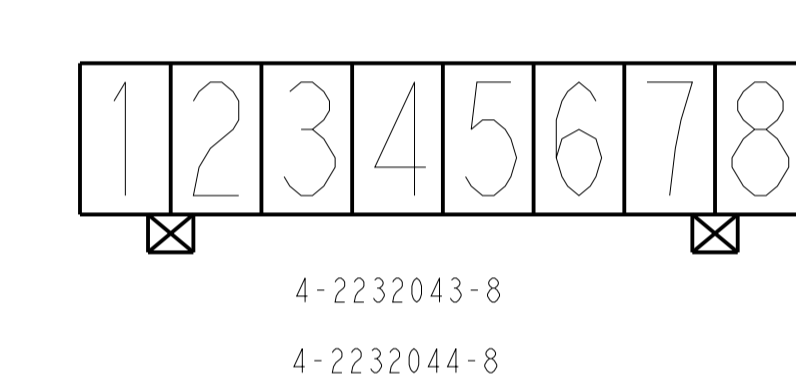
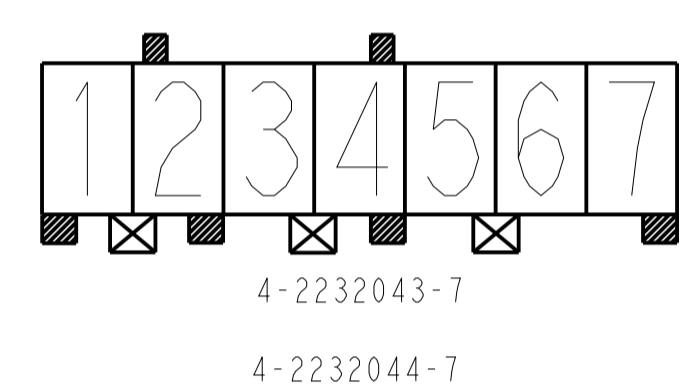
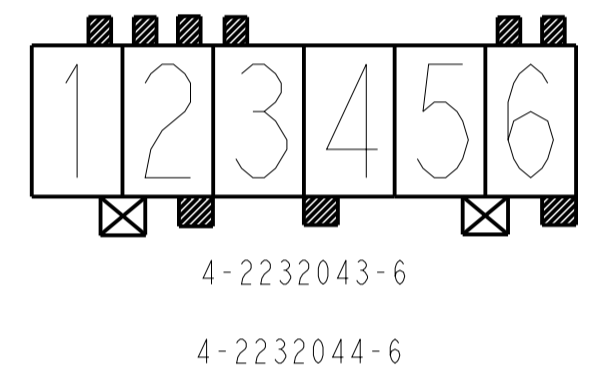
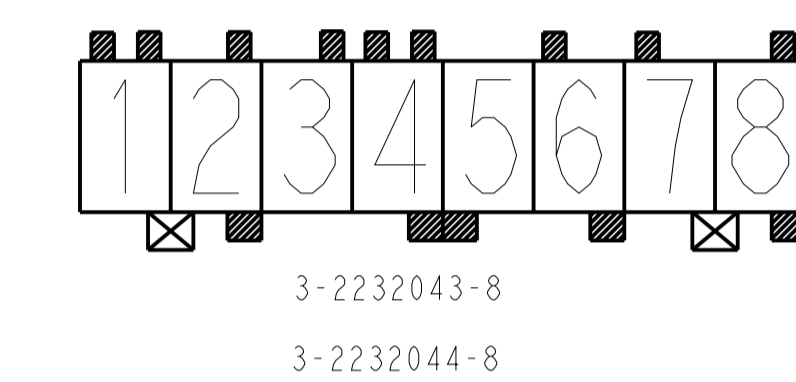
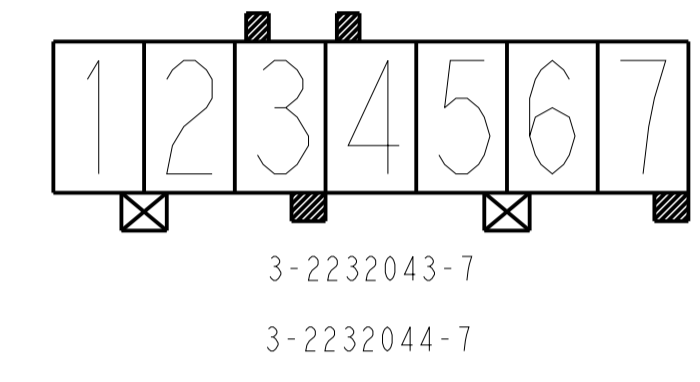
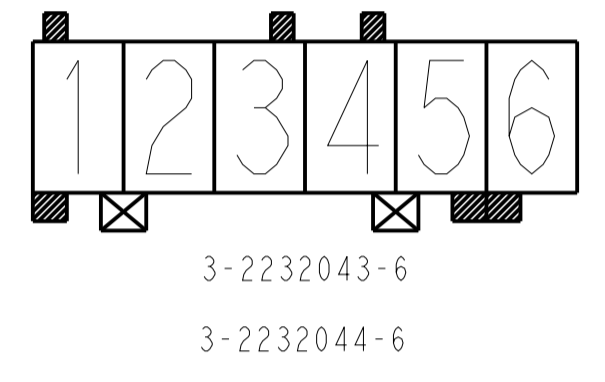
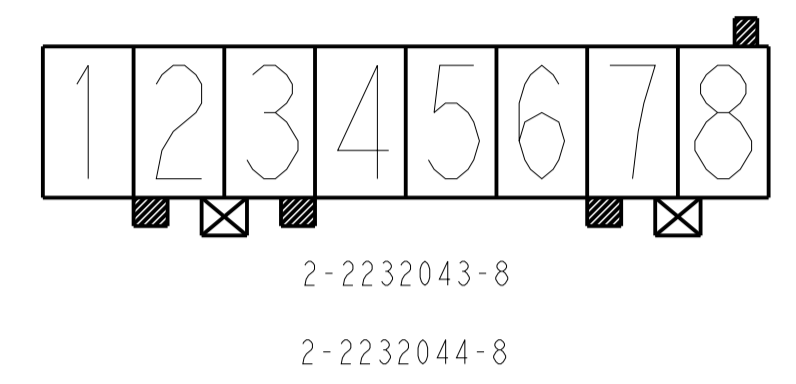
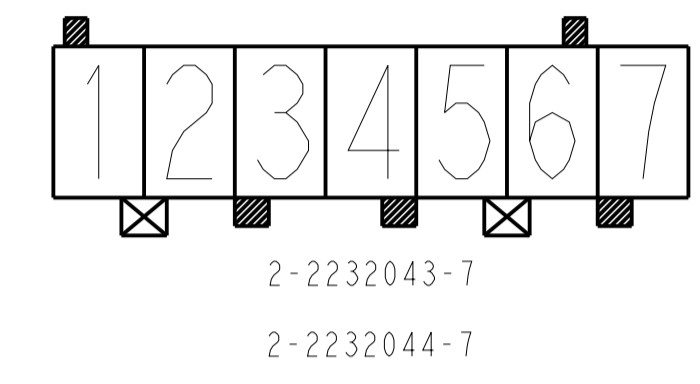
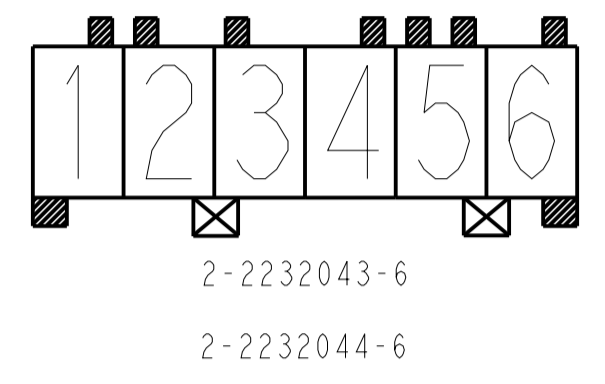
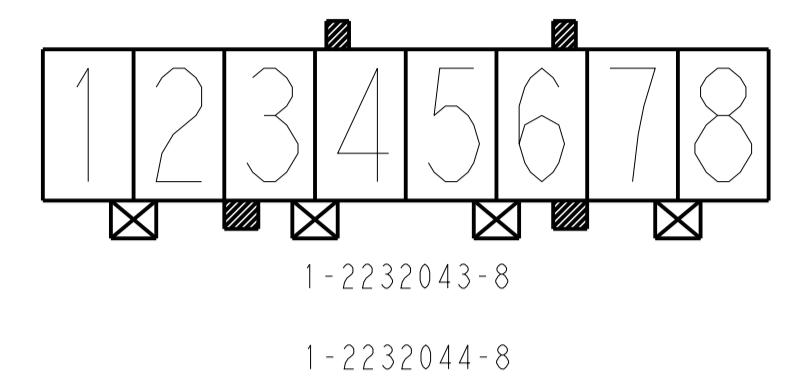
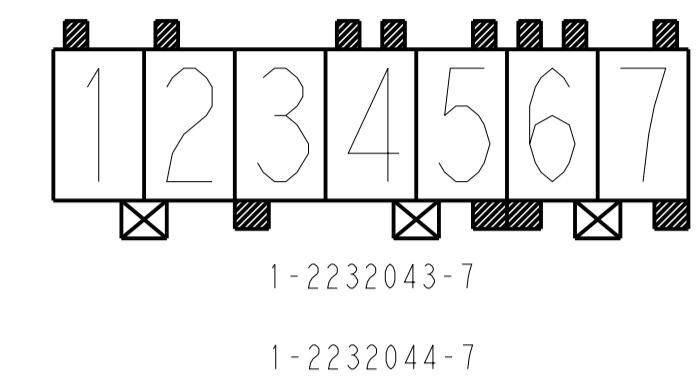
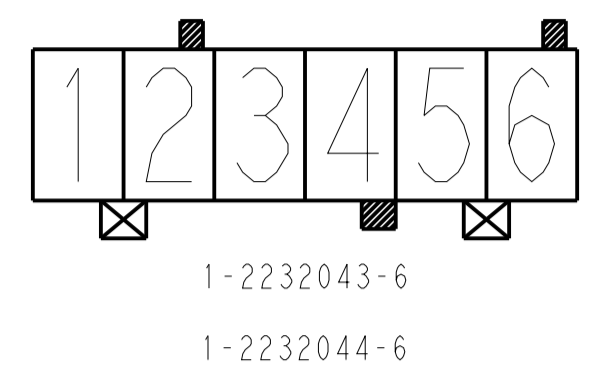
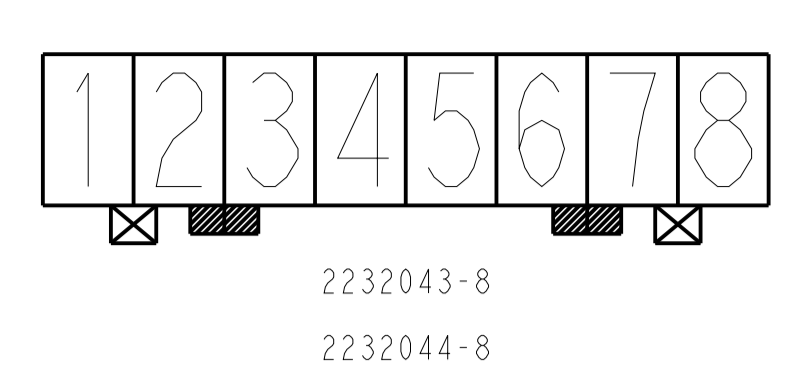
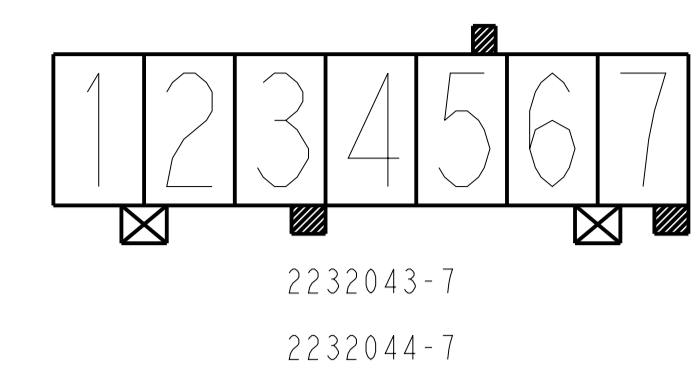
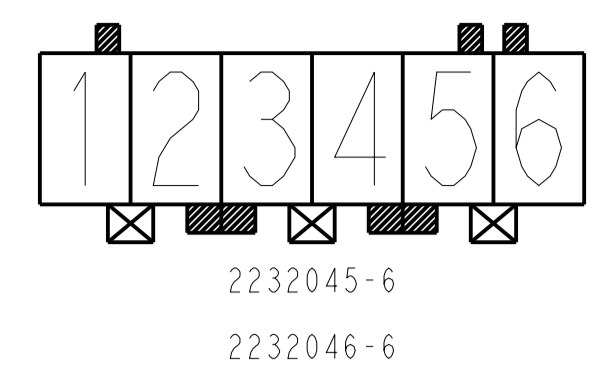
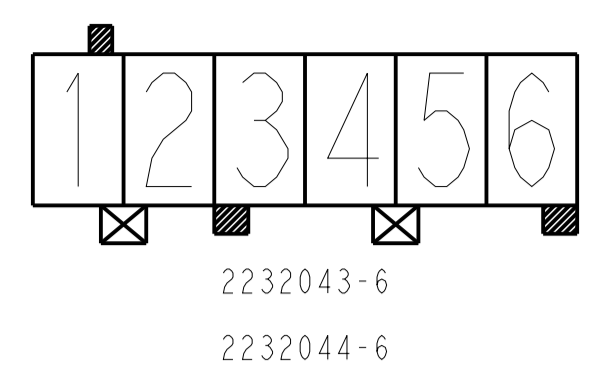

THIS DRAWING IS A CONTROLLED DOCUMENT.		OWN RUIPING WU 30-Jan-13	TE Connectivity	
DIMENSIONS:		CHK HAPYE WU 30-Jan-13	NAME RAST 5 TAB HEADER ASSY, OPPOSITE DIN STYLE, TH, VERTICAL	
mm	TOLERANCES UNLESS OTHERWISE SPECIFIED:	APPV YIM 30-Jan-13	PRODUCT SPEC	
	0 PLC ±		APPLICATION SPEC	
	1 PLC ±0.25		SIZE CAGE CODE DRAWING NO	
	2 PLC ±		A1 00779 C-2232043	
	3 PLC ±		RESTRICTED TO	
	4 PLC ±		SCALE N/A SHEET 5 OF 6 REV B	
	ANGLES ±0°		CUSTOMER DRAWING	
MATERIAL	FINISH	WTGHT		

LOC		DIST		REVISIONS			
				REV	DATE	BY	APPV

FOR ANY KEYING CONFIGURATION, THERE ARE EIGHT COLORS AVAILABLE. BESIDES THE NATURAL COLOR, THERE ARE OTHER SEVEN COLORS, INCLUDE: YELLOW, BLUE, GREY, PURPLE, RED, GREEN, BLACK. THE WHITE VERSION IS PRELIMINARY. THE P/N OF THE COLOR CONNECTOR ARE BASED ON THE NATURAL CONNECTOR. THE PREFIX AND POSTFIX ARE THE SAME FOR THE SAME KEYING CONFIGURATION, BUT THE BASE NUMBERS ARE DIFFERENT ACCORDING TO DIFFERENT COLOR. THE FOLLOWING SHOWS WHAT'S THE P/N FOR COLOR CONNECTOR

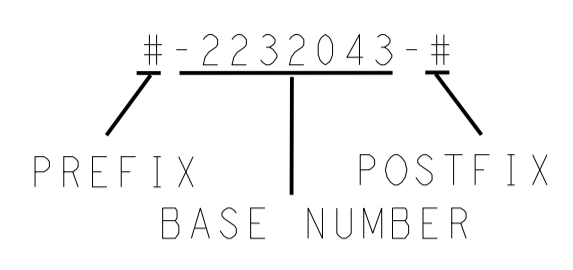

COLOR	PART NUMBER OF THE CONNECTOR				COMMENTS
	WITH MATT TIN PLATING CONTACT (SPECIAL P/N: 8-2232043-7 ARE WITH BRIGHT TIN)		WITH AG PLATING CONTACT		
NATURAL	#-2232043-# 9	#-2232045-#	#-2232044-#	#-2232046-#	THE DETAIL P/N FOR DIFFERENT KEYING SEE SHEET 2-5
RED	#-2232055-#	#-2232057-#	#-2232056-#	#-2232058-#	THE PREFIX AND POSTFIX ARE THE SAME WITH THE P/N OF THE NATURAL CONNECTOR FOR THE SAME KEYING CONFIGURATION, JUST THE BASE NUMBERS ARE DIFFERENT BASED ON DIFFERENT COLOR. # CAN BE THE NUMBER FROM 0 TO 9.
BLUE	#-2232047-#	#-2232049-#	#-2232048-#	#-2232050-#	
YELLOW	#-2232063-#	#-2232065-#	#-2232064-#	#-2232066-#	
BALCK	#-2232059-#	#-2232061-#	#-2232060-#	#-2232062-#	
GREY	#-2232067-#	#-2232069-#	#-2232068-#	#-2232070-#	
GREEN	#-2232051-#	#-2232053-#	#-2232052-#	#-2232054-#	
PURPLE	#-2232071-#	#-2232073-#	#-2232072-#	#-2232074-#	
WHITE	#-2232298-#	#-2232300-#	#-2232299-#	#-2232301-#	

COLOR	PART NUMBER OF THE CONNECTOR		COMMENTS
	WITH BRIGHT PLATING CONTACT		
NATURAL	#-2232924-#	#-2232925-#	THE KEYING, POLARIZATION AND LATCH WINDOW CONFIGURATION ARE SAME AS THE MATT TIN CONNECTOR WITH THE SAME PREFIX AND POSTFIX FOR EACH COLOR. FOR EXAMPLE: 2232924-4 AND 2232043-4 HAVE SAME KEYING, POLARIZATION AND LATCH WINDOW CONFIGURATION. 2232925-4 AND 2232045-4 HAVE SAME KEYING, POLARIZATION AND LATCH WINDOW CONFIGURATION. THE DETAIL KEYING, POLARIZATION AND LATCH WINDOW CONFIGURATION FOR EACH P/N, PLEASE SEE SHEET 2-5
RED	#-2232926-#	#-2232927-#	
BLUE	#-2232928-#	#-2232929-#	
YELLOW	#-2232930-#	#-2232931-#	
BALCK	#-2232932-#	#-2232933-#	
GREY	#-2232934-#	#-2232935-#	
GREEN	#-2232936-#	#-2232937-#	
PURPLE	#-2232938-#	#-2232939-#	
WHITE	#-2232940-#	#-2232941-#	

FOR EXAMPLE, IF A CONNECTOR WITH THE CONFIGURATION AS BELOW, AND WITH TIN PLATING CONTACT, IN THE SHEET 4, WE CAN FIND THE RELATED CONNECTOR P/N WITH NATURAL COLOR IS 1-2232043-4, THEN WE CAN LOOK IN THE ABOVE TABLE TO FIND THE CONNECTOR P/N WITH RED COLOR IS 1-2232055-4

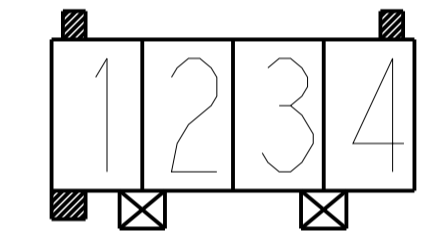

1-2232043-4

FOR ANOTHER EXAMPLE, IF A CONNECTOR WITH THE CONFIGURATION AS BELOW, AND WITH TIN PLATING CONTACT, IN THE SHEET 4, WE CAN FIND THE RELATED CONNECTOR P/N WITH NATURAL COLOR IS 1-2232045-4, THEN WE CAN LOOK IN THE ABOVE TABLE TO FIND THE CONNECTOR P/N WITH RED COLOR IS 1-2232057-4

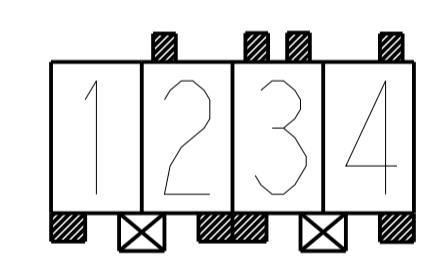

1-2232045-4

THIS DRAWING IS A CONTROLLED DOCUMENT.		OWN: RUIPING.WU 08-Apr-21 CHK: HAPYE.WU 08-Apr-21 APPV: YUAM 08-Apr-21	TE Connectivity NAME: RAST 5 TAB HEADER ASSY, OPPOSITE DIN STYLE, TH, VERTICAL	
DIMENSIONS:	TOLERANCES UNLESS OTHERWISE SPECIFIED:	PRODUCT SPEC: 108-106080 APPLICATION SPEC:		
mm	0 PLC ± 1 PLC ± 2 PLC ±0.25 3 PLC ± 4 PLC ±	WEIGHT: -	RESTRICTED TO: -	
MATERIAL: -	FINISH: -	Customer Drawing	SCALE: 5:1 SHEET: 6 OF 6 REV: B	

## X-ON Electronics

Largest Supplier of Electrical and Electronic Components

*Click to view similar products for [Headers & Wire Housings](#) category:*

*Click to view products by [TE Connectivity](#) manufacturer:*

Other Similar products are found below :

[892-18-020-10-001101](#) [58102-G61-06LF](#) [582553-1](#) [0009485154](#) [009176003701906](#) [0050291907](#) [LY20-4P-DT1-P1E-BR](#) [02.125.8002.8](#)  
[609-3404](#) [61062-3](#) [61082-181009](#) [622-3653LF](#) [63453-116](#) [636-1030](#) [636-1427](#) [636-3427](#) [636-4007](#) [641938-9](#) [641991-4](#) [644827-2](#) [65817-](#)  
[010LF](#) [65817-015LF](#) [65863-015LF](#) [66207-023LF](#) [67095-007LF](#) [67601157](#) [68645-018](#) [68648-049](#) [70.362.1628.0](#) [70-4210](#) [70-4226B](#) [70-](#)  
[4853B](#) [707-5020](#) [707-5028](#) [71.350.2428.0](#) [71918-208LF](#) [71961-016LF](#) [733-134](#) [733-162](#) [754199-000](#) [760-3052](#) [787-8014-00](#) [79531-3000](#)  
[FCN-360C032-B](#) [FCN-367T-T012/H](#) [FCN-723D010/2](#) [80.063.4001.1](#) [800-90-001-10-001000](#) [800-90-010-10-002000](#) [801-43-002-10-013000](#)