

P	LTR	DESCRIPTION	DATE	DWN	APVD
	A	INITIAL RELEASE	20JUN2020	J.S	I.Y
	A1	ECR-20-010349	26JUL2020	J.G	I.Y
	A2	ECN-21-113425	17AUG2021	J.G	Z.Z

2CCT PLUG CONNECTOR

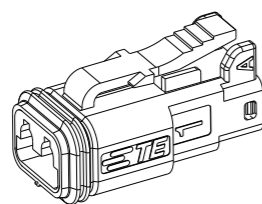

2CCT PLUG CONNECTOR WITH HEATSHRINK HOUSING ULTRASONICALLY WELDED IN PLACE

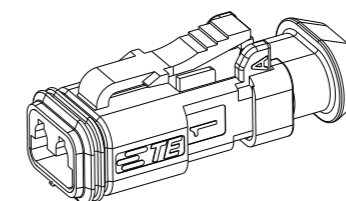

DATE CODE: X XX XX
 X- DAY: 1 - 7
 XX- WEEK: 01 - 52
 XX- YEAR: 00 - 99

#- MACHINE NO. 1

EXAMPLE: 11315 = DAY 1, WEEK 13, YEAR 15
 i.e. 23RD OF MARCH 2015

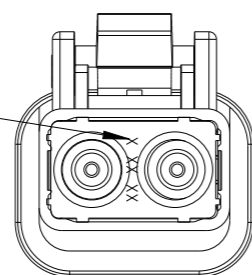

DETAIL A
 SCALE 2:1

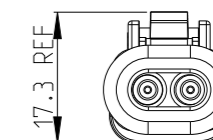
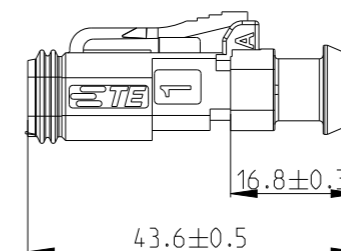
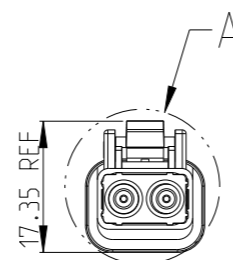
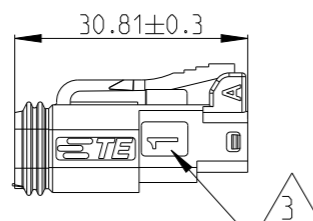
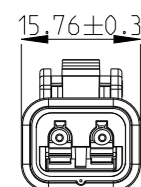
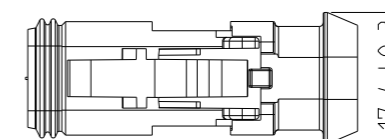

1. THIS PLUG MATES WITH RECEP ASSEMBLY PN X-2600022-X, WEDGE LOCK PN W2SX.

2. MATERIAL
 PLUG HOUSING: NYLON GF30, PLUG SEAL: SILICONE RUBBER, RED
 BACK SEAL: SILICONE RUBBER
 BACK COVER: NYLON GF30, BLACK
 HEATSHRINK HOUSING: NYLON GF30, BLACK

3 CIRCUIT IDENTIFICATION

4. JACKET RANGE LARGE = 2.23mm - 3.68mm (SEAL COLOUR: GREEN)
 JACKET RANGE SMALL = 1.20mm - 3.05mm (SEAL COLOUR: BURNT ORANGE)

5. SEE SHEET 2 FOR FINAL PART NUMBER DESIGNATION

THIS DRAWING IS A CONTROLLED DOCUMENT.		DWN J.Shang 20JUN2020	TE Connectivity NAME 2CCT DT-XT PLUG CONNECTOR			
DIMENSIONS: mm		CHK E.Jiang 20JUN2020				
TOLERANCES UNLESS OTHERWISE SPECIFIED:		APVD I.Yin 20JUN2020				
0 PLC ± 1 PLC ± 2 PLC ± 3 PLC ± 4 PLC ± ANGLES ±		PRODUCT SPEC 108-160026				
MATERIAL		APPLICATION SPEC 114-160017	SIZE A3	CAGE CODE 00779	DRAWING NO C-2600023	RESTRICTED TO
		WEIGHT -	SCALE 1:1		SHEET 1 OF 2	REV A2
		CUSTOMER DRAWING				

P	LTR	DESCRIPTION	DATE	DWN	APVD
		SEE SHEET 1			

3- -6	934451609	-	5.81
3- -5	934451608	-	5.81
3- -4	934451607	-	5.81
3- -3	934451606	-	5.81
3- -2	934451605	-	5.81
3- -1	934451604	-	5.81
3- -0	934451603	-	5.81
2- -9	934451602	-	5.81
2- -8	934451601	-	5.81
2- -7	934451509	-	5.81
2- -6	934451508	-	5.81
2- -5	934451507	-	5.81
2- -4	934451506	-	5.81
2- -3	934451505	-	5.81
2- -2	934451504	-	5.81
2- -1	934451503	-	5.81
2- -0	934451502	-	5.81
1- -9	934451501	-	5.81
1- -8	934451209	-	4.27
1- -7	934451208	-	4.27
1- -6	934451207	-	4.27
1- -5	934451206	-	4.27
1- -4	934451205	-	4.27
1- -3	934451204	-	4.27
1- -2	934451203	-	4.27
1- -1	934451202	-	4.27
1- -0	934451201	-	4.27
-9	934451109	-	4.27
-8	934451108	-	4.27
-7	934451107	-	4.27
-6	934451106	-	4.27
-5	934451105	-	4.27
-4	934451104	-	4.27
-3	934451103	-	4.27
-2	934451102	-	4.27
-1	934451101	-	4.27

QTY. REQUEST PER ASSY

-	-	-	-	-	-	-	-	-	1	-	-	-	-	-	-	-
-	-	-	-	-	-	-	-	1	-	-	-	-	-	-	-	-
-	-	-	-	-	-	-	1	-	-	-	-	-	-	-	-	-
-	-	-	-	-	-	1	-	-	-	-	-	-	-	-	-	-
-	-	-	1	-	-	-	-	-	-	-	-	-	-	-	-	-
-	1	-	-	-	-	-	-	-	-	-	-	-	-	-	-	-
-	-	-	-	-	-	-	-	-	1	1	-	-	-	-	-	-
-	-	-	-	-	-	-	-	-	1	-	1	-	-	-	-	-
-	-	-	-	-	-	1	-	-	-	-	1	-	-	-	-	-
-	-	-	-	1	-	-	-	-	-	-	1	-	-	-	-	-
-	-	1	-	-	-	-	-	-	-	-	1	-	-	-	-	-
-	1	-	-	-	-	-	-	-	-	-	1	-	-	-	-	-
-	-	-	-	-	-	-	-	-	-	1	-	-	-	-	-	-
-	-	-	-	-	-	-	1	-	-	-	-	-	-	-	-	-
-	-	-	-	1	-	-	-	-	-	-	-	-	-	-	-	-
-	-	1	-	-	-	-	-	-	-	-	-	-	-	-	-	-
1	-	-	-	-	-	-	-	-	-	-	-	-	-	-	-	-
-	-	-	-	-	-	-	-	-	1	1	-	-	-	-	-	-
-	-	-	-	-	-	-	-	-	1	-	-	-	-	-	-	-
-	-	-	-	-	-	-	-	1	-	-	-	-	-	-	-	-
-	-	-	-	-	-	1	-	-	-	-	-	-	-	-	-	-
-	-	-	-	-	-	-	-	-	-	-	-	-	-	-	-	-
-	-	-	-	-	-	-	-	-	1	-	-	-	-	-	-	-
-	-	-	-	-	-	-	-	-	-	-	-	-	-	-	-	-
-	-	-	-	-	-	-	1	-	-	-	-	-	-	-	-	-
-	-	-	-	-	-	1	-	-	-	-	-	-	-	-	-	-
-	-	-	-	-	-	1	-	-	-	-	-	-	-	-	-	-
1	-	-	-	-	-	-	-	-	-	-	-	-	-	-	-	-
-	-	-	-	-	-	-	-	-	-	1	1	-	-	-	-	-
-	-	-	-	-	-	-	-	-	1	-	-	-	-	-	-	-
-	-	-	-	-	-	1	-	-	-	-	-	-	-	-	-	-
-	-	-	-	-	-	-	-	-	-	-	-	-	-	-	-	-
1	-	-	-	-	-	-	-	-	-	-	-	-	-	-	-	-

TE PN	ALIAS PN	REVISION OF EACH ASSY NO.	WEIGHT OF EACH ASSY(g)	COLOUR	BLACK	GERY	GREEN	BLUE	YELLOW	WHITE	BROWN	ORANGE	RED	BURNT ORANGE	GREEN	BLACK	BLACK	
				MATERIAL	NYLON GF30	NYLON GF30	NYLON GF30	NYLON GF30	NYLON GF30	NYLON GF30	NYLON GF30	NYLON GF30	NYLON GF30	SILICONE RUBBER	SILICONE RUBBER	NYLON GF30	NYLON GF30	
				DESCRIPTION	PLUG HOUSING										BACK SEAL SMALL	BACK SEAL LARGE	BACK COVER	HEATSHRINK HOUSING
				ITEM NO	1										2		3	4

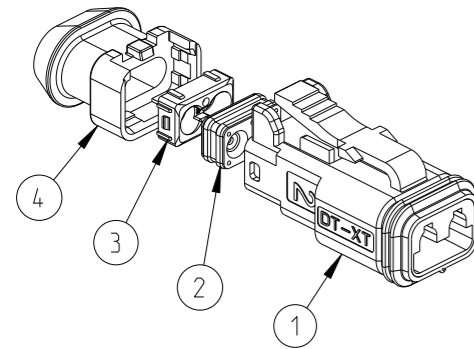

THIS DRAWING IS A CONTROLLED DOCUMENT.

DWN J. Shang 20JUN2020
 CHK E. Jiang 20JUN2020
 APVD L. Yin 20JUN2020

PRODUCT SPEC: 108-160026
 APPLICATION SPEC: 114-160017
 WEIGHT: -

CUSTOMER DRAWING

SCALE: 1:1 SHEET 2 OF 2 REV A2

TE Connectivity

NAME: 2CCT DT-XT PLUG CONNECTOR

SIZE: A3 CAGE CODE: 00779 DRAWING NO: ©=2600023 RESTRICTED TO

X-ON Electronics

Largest Supplier of Electrical and Electronic Components

Click to view similar products for [Automotive Connectors](#) category:

Click to view products by [TE Connectivity](#) manufacturer:

Other Similar products are found below :

[003-018-000](#) [60993906-B](#) [M902-2131](#) [M902-2161](#) [M902-2344](#) [72.330.1035.1](#) [73.353.4028.0](#) [F166900](#) [F358300-B](#) [F407400](#) [776880-1](#)
[827153-1](#) [8N1515-32-24P](#) [9-1326729-8](#) [925474-1](#) [928905-1](#) [964562-4](#) [968782-1](#) [98891-1012](#) [12004475-L](#) [12020308](#) [12041318-B](#)
[12052466](#) [12064869](#) [12015909](#) [1-21030-1](#) [12041254](#) [12041318](#) [12047946-B](#) [12110546-B](#) [12131792](#) [12084688](#) [12092346](#) [HD34-18-14PT](#)
[HD46-24-23SN-059](#) [HDB36-24-16PN-059](#) [HDP26-24-9SE-L015](#) [12185280](#) [12185550](#) [12336-12](#) [12191172-B](#) [12S](#) [13545280](#) [13577943](#)
[13681974](#) [13737722-B](#) [13830674](#) [13832576](#) [13849772](#) [13542772](#)