

THIS DRAWING IS UNPUBLISHED.

RELEASED FOR PUBLICATION

© COPYRIGHT

ALL RIGHTS RESERVED.

LOC  
DY

DIST  
-

REVISIONS

P	LTR	DESCRIPTION	DATE	DWN	APVD
E1		REVISED PER ECO-11-005139	26APR11	RK	HMR

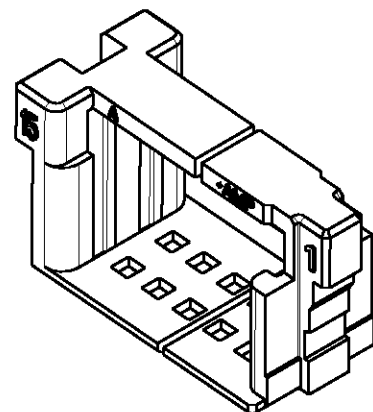
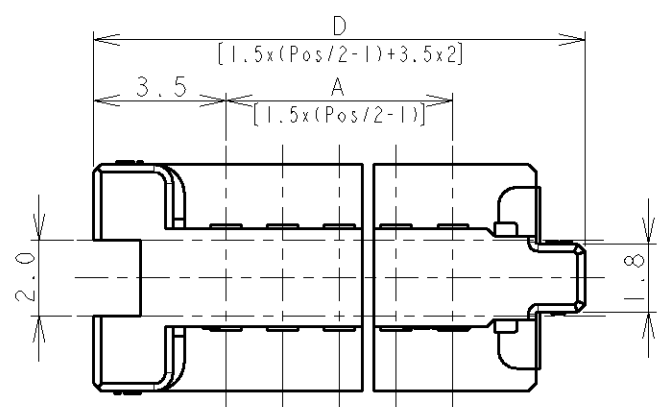

NOTES:  
 1. MATERIAL: 66NYLON UL94V-0, COLOR: WHITE, BLUE  
 2. APPLICABLE CONNECTOR PART NUMBER:  
 X-353293-X (REC ASS'Y)  
 3. PROFILE DEVIATION AT LOCATION SHOWN ALLOWED UP TO 1.5 MAX

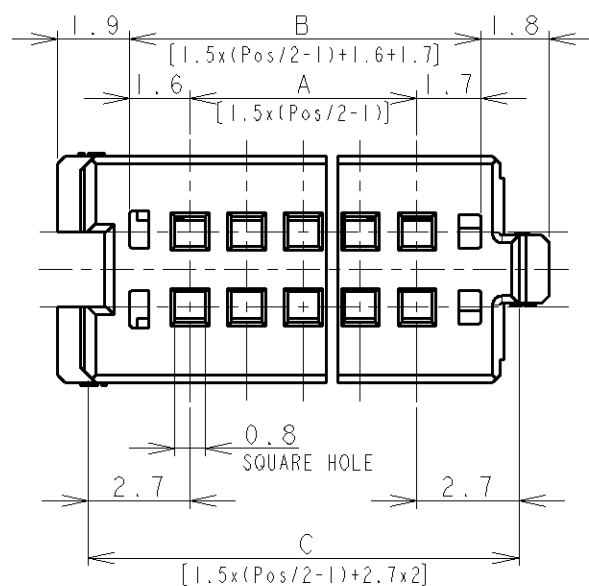
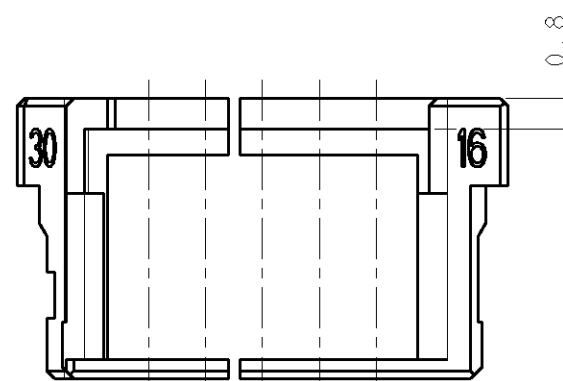
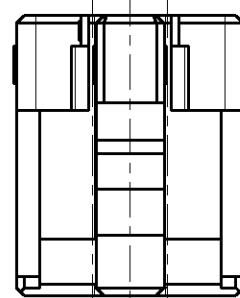
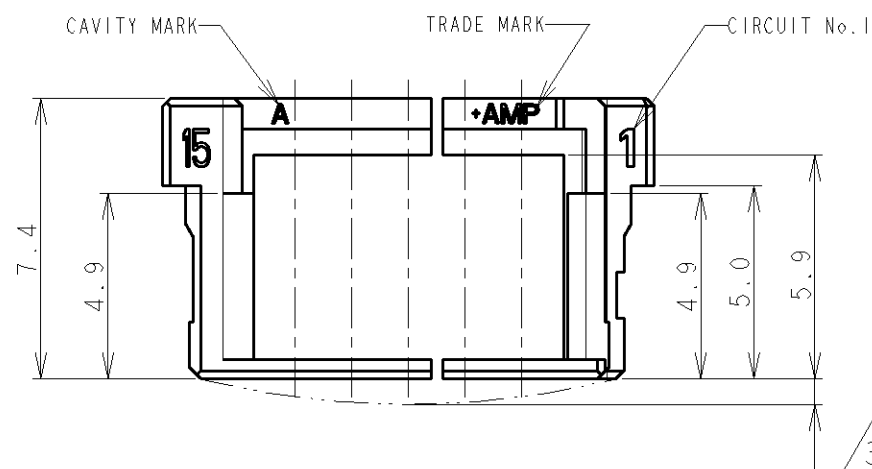
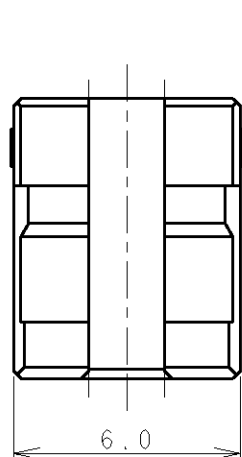

0.30	35.5	33.9	31.8	28.5	40	9-353294-0	4-353294-0
0.29	34.0	32.4	30.3	27.0	38	8-353294-8	3-353294-8
0.28	32.5	30.9	28.8	25.5	36	8-353294-6	3-353294-6
0.27	31.0	29.4	27.3	24.0	34	8-353294-4	3-353294-4
0.26	29.5	27.9	25.8	22.5	32	8-353294-2	3-353294-2
0.25	28.0	26.4	24.3	21.0	30	8-353294-0	3-353294-0
0.24	26.5	24.9	22.8	19.5	28	7-353294-8	2-353294-8
0.23	25.0	23.4	21.3	18.0	26	7-353294-6	2-353294-6
0.22	23.5	21.9	19.8	16.5	24	7-353294-4	2-353294-4
0.21	22.0	20.4	18.3	15.0	22	7-353294-2	2-353294-2
0.20	20.5	18.9	16.8	13.5	20		

WEIGHT (g)	DIMENSIONS				Pos	PART NUMBER	
	D	C	B	A		BLUE	WHITE

DIMENSIONS: mm		TOLERANCES UNLESS OTHERWISE SPECIFIED: 0 PLC ± 1 PLC ± 2 PLC ± 3 PLC ± 4 PLC ± ANGLES ±		DWN T. FURUYA 12JUL96 CHK J. TANIGAWA 12JUL96 APVD SF FONG PRODUCT SPEC 108-5525 APPLICATION SPEC 114-5223 WEIGHT SEE TABLE	TE Connectivity	
MATERIAL SEE NOTE 1		FINISH		NAME AMP Mini Common Terminated (CT) Connector 1.5mm PITCH DOUBLE ROW HOLDER HOUSING		SIZE A3
CUSTOMER DRAWING				CAGE CODE 00779	DRAWING NO. C-353294	SCALE 5:1 SHEET 1 OF 1 REV E1

## X-ON Electronics

Largest Supplier of Electrical and Electronic Components

*Click to view similar products for [Headers & Wire Housings](#) category:*

*Click to view products by [TE Connectivity](#) manufacturer:*

Other Similar products are found below :

[892-18-020-10-001101](#) [58102-G61-06LF](#) [582553-1](#) [0009485154](#) [009176003701906](#) [0050291907](#) [LY20-4P-DT1-P1E-BR](#) [02.125.8002.8](#)  
[609-3404](#) [61062-3](#) [61082-181009](#) [622-3653LF](#) [63453-116](#) [636-1030](#) [636-1427](#) [636-3427](#) [636-4007](#) [641938-9](#) [641991-4](#) [644827-2](#) [65817-010LF](#) [65817-015LF](#) [65863-015LF](#) [66207-023LF](#) [67095-007LF](#) [67601157](#) [68645-018](#) [68648-049](#) [70.362.1628.0](#) [70-4210](#) [70-4226B](#) [70-4853B](#) [707-5020](#) [707-5028](#) [71.350.2428.0](#) [71918-208LF](#) [71961-016LF](#) [733-134](#) [733-162](#) [754199-000](#) [760-3052](#) [787-8014-00](#) [79531-3000](#)  
[FCN-360C032-B](#) [FCN-367T-T012/H](#) [FCN-723D010/2](#) [80.063.4001.1](#) [800-90-001-10-001000](#) [800-90-010-10-002000](#) [801-43-002-10-013000](#)