

REVISIONS					
P	LTR	DESCRIPTION	DATE	DWN	APVD
	D5	ECN-21-114380:ADD MATED CONDITION	31AUG2021	A.L	H.L

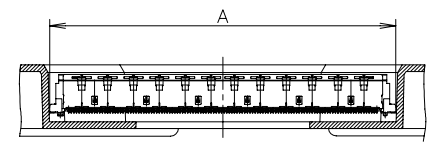

SECT. D-D
(SCALE 2:1)
(CONNECTOR NOT SECTION)

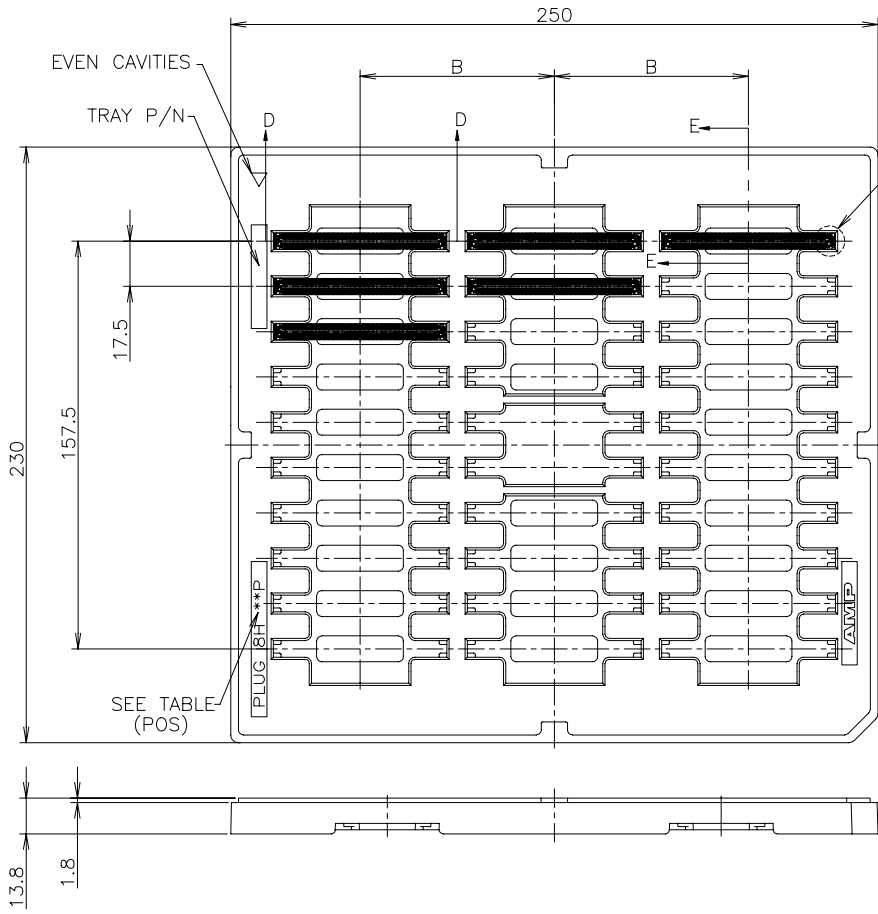
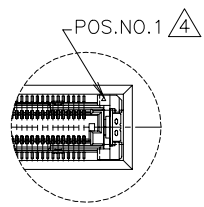

DETAIL C
(SCALE 2:1)

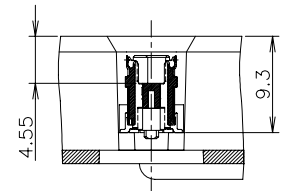

SECT. E-E
(SCALE 2:1)

WITHOUT PICK UP CAP

THIS DRAWING IS A CONTROLLED DOCUMENT.		DWN S. CHIEN 26SEP05	<table border="1"> <tr> <td>YES Δ</td> <td>3</td> <td>30</td> <td>75</td> <td>61.8</td> <td>220</td> <td>8-6318491-6</td> </tr> <tr> <td>NO</td> <td>3</td> <td>30</td> <td>75</td> <td>61.8</td> <td>220</td> <td>3-6318491-6</td> </tr> <tr> <td>SEALANT</td> <td>ROW</td> <td>QTY</td> <td>B</td> <td>A</td> <td>POS.</td> <td>PART NO.</td> </tr> </table>				YES Δ	3	30	75	61.8	220	8-6318491-6	NO	3	30	75	61.8	220	3-6318491-6	SEALANT	ROW	QTY	B	A	POS.	PART NO.			
YES Δ	3	30	75	61.8	220	8-6318491-6																								
NO	3	30	75	61.8	220	3-6318491-6																								
SEALANT	ROW	QTY	B	A	POS.	PART NO.																								
<table border="1"> <tr> <td>DIMENSIONS:</td> <td>TOLERANCES UNLESS OTHERWISE SPECIFIED:</td> </tr> <tr> <td>MM</td> <td></td> </tr> <tr> <td></td> <td>0 PLC ± 0.3</td> </tr> <tr> <td></td> <td>1 PLC ± 0.3</td> </tr> <tr> <td></td> <td>2 PLC ± 0.3</td> </tr> <tr> <td></td> <td>3 PLC ± 0.3</td> </tr> <tr> <td></td> <td>4 PLC ± 0.3</td> </tr> <tr> <td></td> <td>ANGLES ± 3'</td> </tr> </table>		DIMENSIONS:	TOLERANCES UNLESS OTHERWISE SPECIFIED:	MM			0 PLC ± 0.3		1 PLC ± 0.3		2 PLC ± 0.3		3 PLC ± 0.3		4 PLC ± 0.3		ANGLES ± 3'	CHK T. FUTATSUGI 26SEP05	<table border="1"> <tr> <td colspan="2">TE Connectivity Ltd.</td> </tr> <tr> <td colspan="2">HARD TRAY ASSY</td> </tr> <tr> <td colspan="2">FH 0.5BTB CONNECTOR 220POS</td> </tr> <tr> <td colspan="2">PLUG 8H WITH GROUND PLATE</td> </tr> </table>				TE Connectivity Ltd.		HARD TRAY ASSY		FH 0.5BTB CONNECTOR 220POS		PLUG 8H WITH GROUND PLATE	
DIMENSIONS:	TOLERANCES UNLESS OTHERWISE SPECIFIED:																													
MM																														
	0 PLC ± 0.3																													
	1 PLC ± 0.3																													
	2 PLC ± 0.3																													
	3 PLC ± 0.3																													
	4 PLC ± 0.3																													
	ANGLES ± 3'																													
TE Connectivity Ltd.																														
HARD TRAY ASSY																														
FH 0.5BTB CONNECTOR 220POS																														
PLUG 8H WITH GROUND PLATE																														
MATERIAL		APVD W. KODAMA 26SEP05	NAME 108-5560		RESTRICTED TO																									
FINISH		PRODUCT SPEC	APPLICATION SPEC		SCALE 1:2																									
		WEIGHT	CUSTOMER DRAWING		SHEET 1 OF 5																									
			SIZE A3 CAGE CODE 00779 DRAWING NO. C=6318491		REV D5																									

REVISIONS					
P	LTR	DESCRIPTION	DATE	DWN	APVD
-	-	SEE SHEET 1	-	-	-

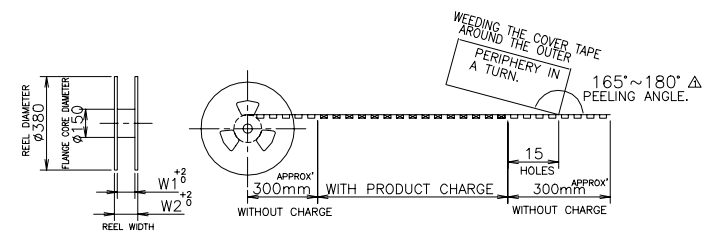
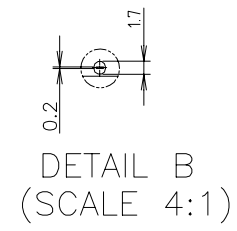
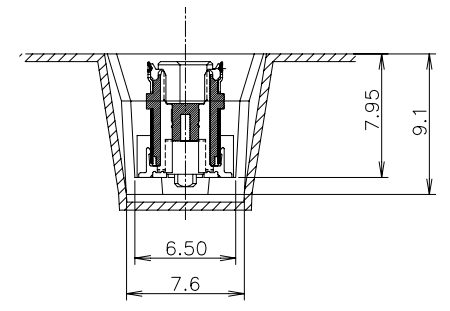
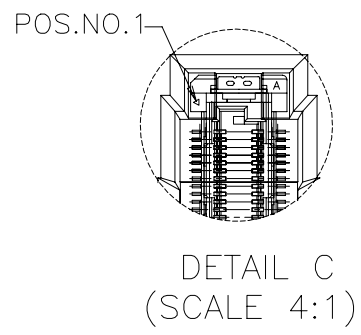
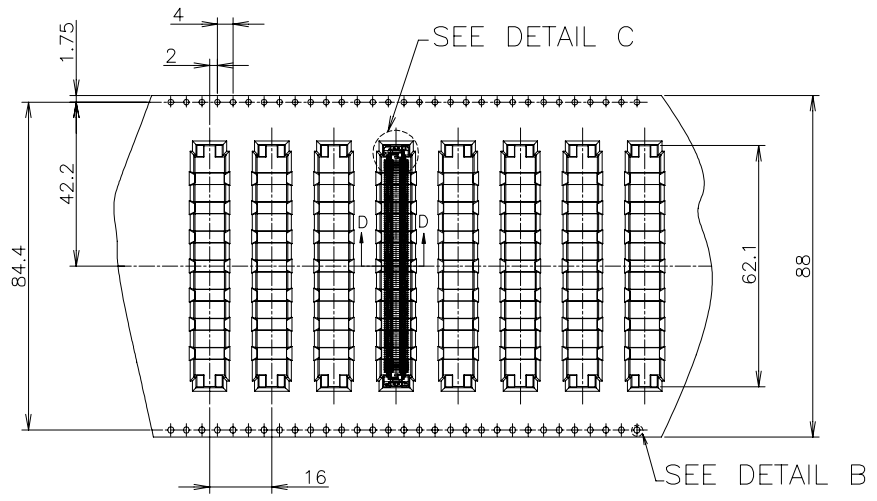

WITHOUT PICK UP CAP

NO	Y	400	93.5	88.5	220	2078455-1	3-5353619-6	4-6318491-6
SEALANT	TOOLING AVAIL	QTY/REEL	W2	W1	POS.	EMBOSS P/N	CONN P/N	PART NO.
THIS DRAWING IS A CONTROLLED DOCUMENT.						DWN S.CHIEN 26SEP05 CHK T.FUTATSUGI 26SEP05 APVD W.KODAMA 26SEP05 PRODUCT SPEC APPLICATION SPEC 108-5560		
DIMENSIONS: MM		TOLERANCES UNLESS OTHERWISE SPECIFIED:		NAME HARD TRAY ASSY FH 0.5BTB CONNECTOR 220POS PLUG 8H WITH GROUND PLATE				
		0 PLC ± 0.3 1 PLC ± 0.3 2 PLC ± 0.3 3 PLC ± 0.3 4 PLC ± 0.3 ANGLES ± 3°		MATERIAL FINISH		WEIGHT SCALE 1:2		RESTRICTED TO
CUSTOMER DRAWING						SIZE A3 CAGE CODE 00779 DRAWING NO. C=6318491	SHEET 2 OF 5 REV D5	

REVISIONS					
P	LTR	DESCRIPTION	DATE	DWN	APVD
-	-	SEE SHEET 1	-	-	-

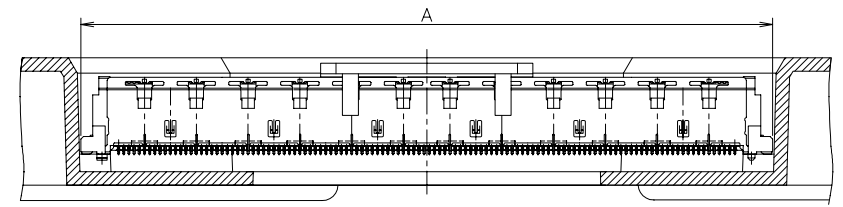
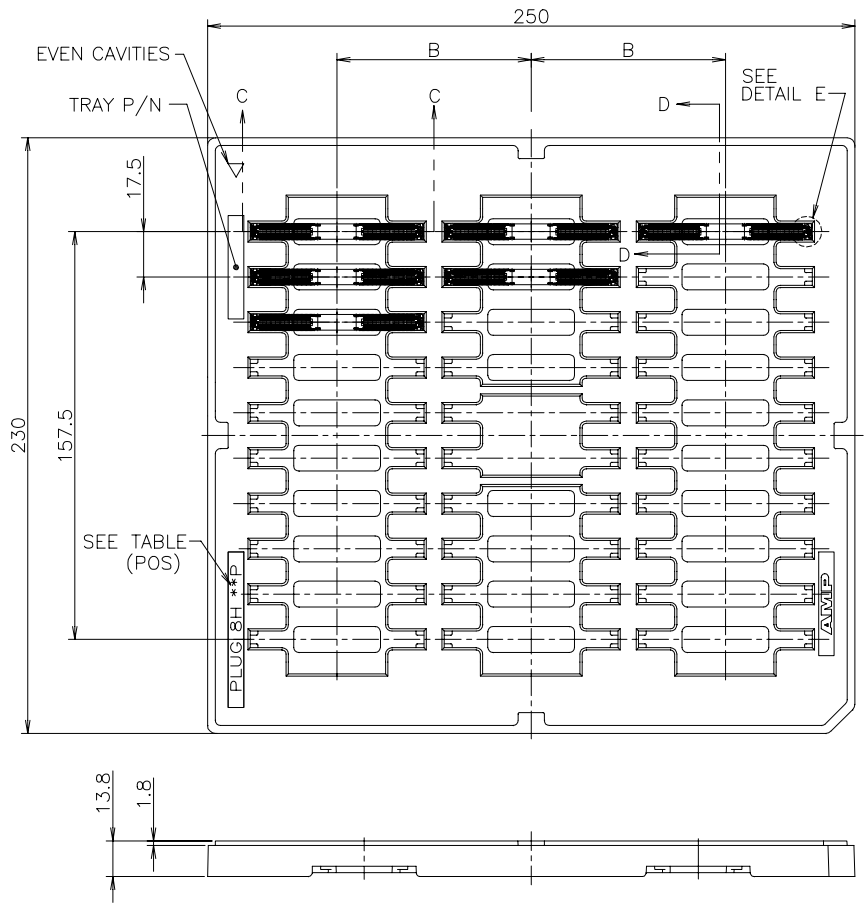

SECT. C-C
(SCALE 2:1)

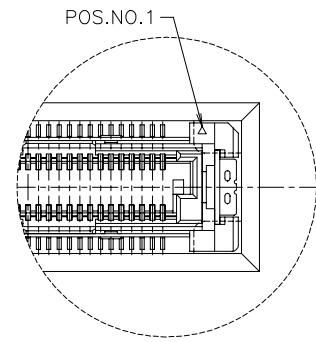

DETAIL E
(SCALE 4:1)

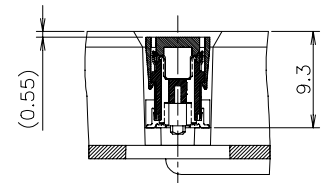

SECT. D-D
(SCALE 2:1)

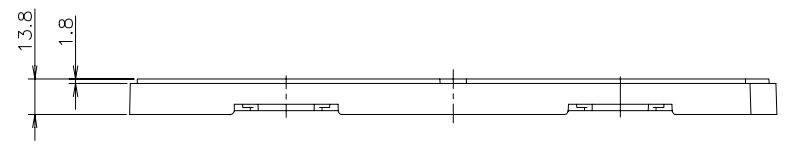

WITH PICK UP CAP

NATURAL	NO	3	30	75	61.8	220	6-6318491-6
BLACK	NO	3	30	75	61.8	220	9-6318491-6
CAP COLOR	SEALANT	ROW	QTY	B	A	POS.	PART NO.

THIS DRAWING IS A CONTROLLED DOCUMENT.		DWN S. CHIEN	TE Connectivity Ltd.				
		CHK T. FUTATSUGI					
		APVD W. KODAMA	NAME				
		PRODUCT SPEC 108-5560	HARD TRAY ASSY FH 0.5BTB CONNECTOR 220POS PLUG 8H WITH GROUND PLATE				
		APPLICATION SPEC	RESTRICTED TO				
		WEIGHT	SIZE A3	CAGE CODE 00779	DRAWING NO C=6318491		
		CUSTOMER DRAWING	SCALE 1:2		SHEET 3 OF 5	REV D5	

P	LTR	DESCRIPTION	DATE	DWN	APVD
-	-	SEE SHEET 1	-	-	-

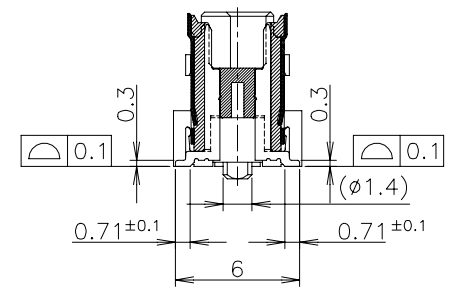
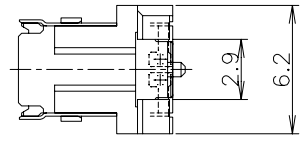
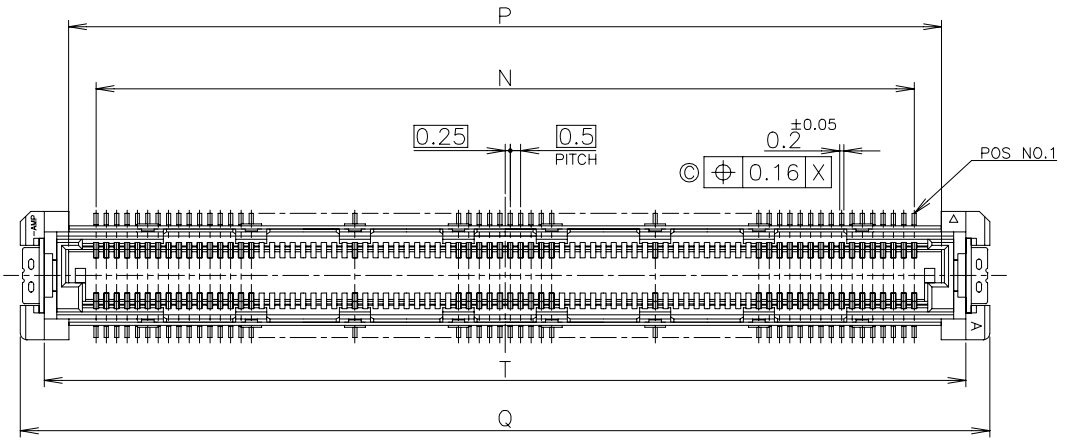

SECT. Z-Z
(SIGNAL POSITION)

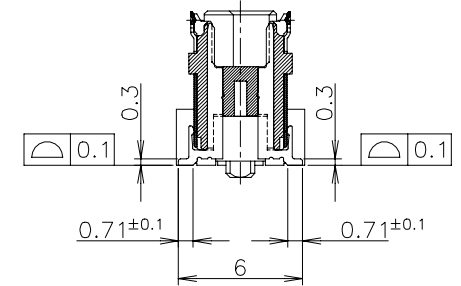
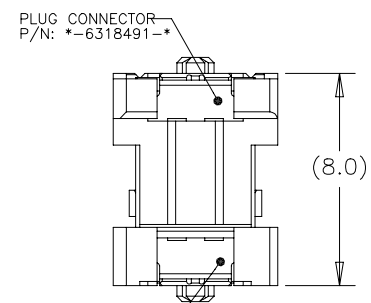
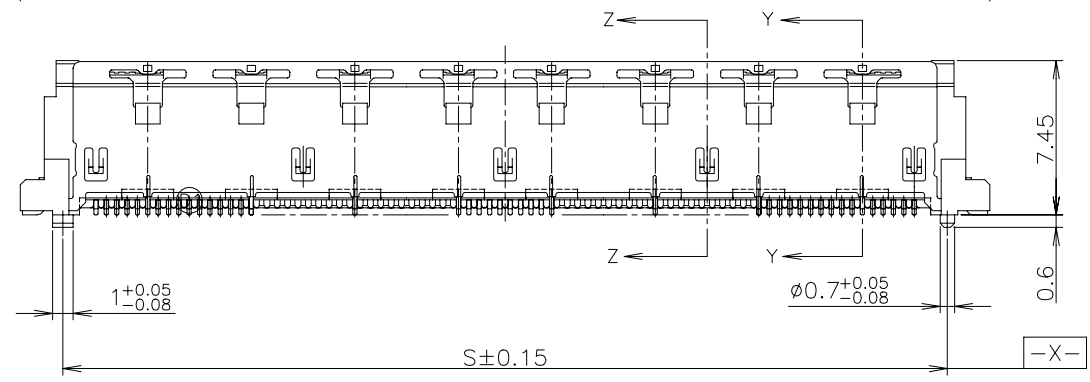

SECT. Y-Y
(GROUND POSITION)

NOTE:

- ① MATERIAL ; HOUSING : HIGH TEMP THERMO PLASTIC UL94V-0
CONTACT : COPPER ALLOY
SOLDER PEG : COPPER ALLOY
- ② FINISH ; SIGNAL CONTACT : UNDER PL Ni 0.0013mm MIN ALL OVER.
CONTACT AREA 0.0002mm MIN Au PL.
SOLDERING AREA 0.001mm MIN TIN PL.
GROUND CONTACT : UNDER PL Ni 0.0013mm MIN ALL OVER.
CONTACT AREA 0.0002mm MIN Au PL.
SOLDERING AREA 0.001mm MIN TIN PL.
SOLDER PEG : 0.001mm MIN TIN PL. OVER
0.0013mm MIN Ni PL ALL OVER.
- ③ THIS POSITION IS GROUND CIRCUIT.
- ④ THIS PRODUCT WAS COATED BY FLUX-PENETRATION-INHIAITING AGENT.

59.5	57.7	61.8	57.1	54.5	220	BLACK	X-6318491-6
T	S	Q	P	N	POS.	HSG COLOR	PART NO.

THIS DRAWING IS A CONTROLLED DOCUMENT.

DIMENSIONS: MM	TOLERANCES UNLESS OTHERWISE SPECIFIED:	DWN
	0 PLC ± 0.3	CHK
	1 PLC ± 0.3	APVD
	2 PLC ± 0.3	PRODUCT SPEC
	3 PLC ± 0.3	APPLICATION SPEC
	4 PLC ± 0.3	WEIGHT
	ANGLES ± 3'	CUSTOMER DRAWING
MATERIAL	FINISH	
①	②	

TE TE Connectivity Ltd.

NAME: HARD TRAY ASSY
FH 0.5BTB CONNECTOR 220POS
PLUG 8H WITH GROUND PLATE

SIZE: A3 CAGE CODE: 00779 DRAWING NO: C=6318491 RESTRICTED TO

SCALE: 4:1 SHEET: 4 OF 5 REV: D5

REVISIONS

P	LTR	DESCRIPTION	DATE	DWN	APVD
-	-	SEE SHEET 1	-	-	-

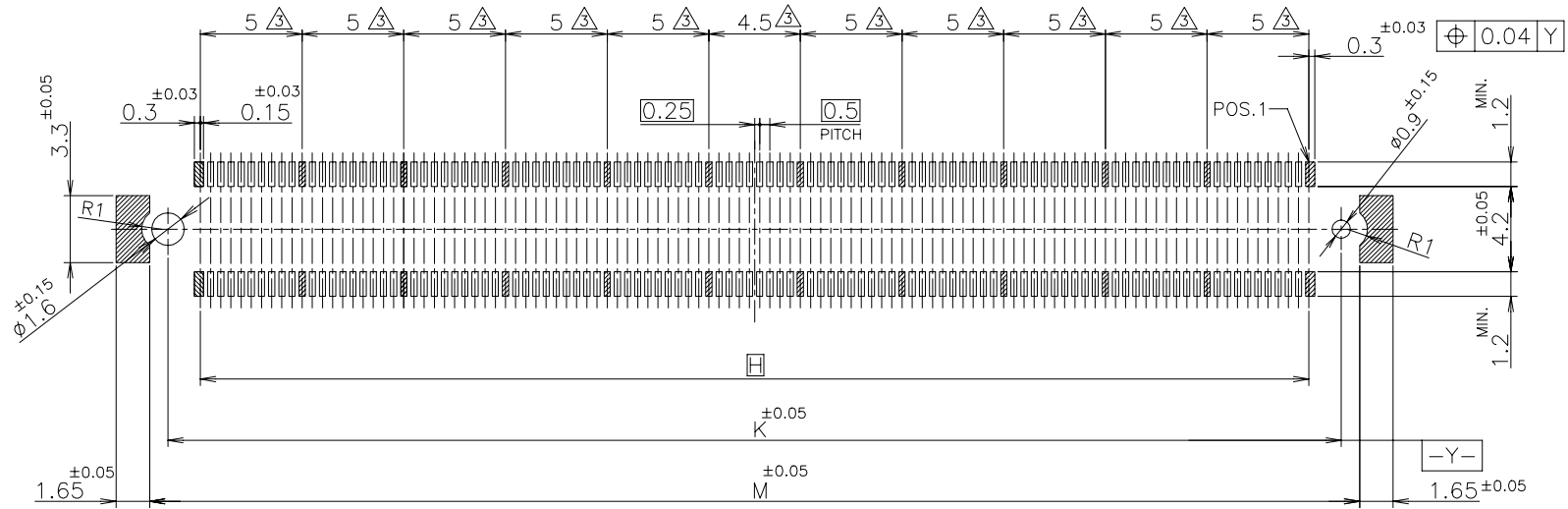

REFERENCE P.C. BOARD LAYOUT

59.5	57.7	54.5	220	X-6318491-6
M	K	H	POS	PART NO.

THIS DRAWING IS A CONTROLLED DOCUMENT.		DWN	TE Connectivity Ltd.		
DIMENSIONS: MM		CHK			
TOLERANCES UNLESS OTHERWISE SPECIFIED:		APVD	HARD TRAY ASSY		
0 PLC ± 0.3		PRODUCT SPEC	FH 0.5BTB CONNECTOR 220POS		
1 PLC ± 0.3		APPLICATION SPEC	PLUG 8H WITH GROUND PLATE		
2 PLC ± 0.3		WEIGHT	SIZE	CAGE CODE	DRAWING NO
3 PLC ± 0.3		CUSTOMER DRAWING	A3	00779	C=6318491
4 PLC ± 0.3			SCALE	SHEET	REV
ANGLES ± 3°			4:1	5 OF 5	D5
MATERIAL	FINISH				
1	2				

X-ON Electronics

Largest Supplier of Electrical and Electronic Components

Click to view similar products for [Board to Board & Mezzanine Connectors](#) category:

Click to view products by [TE Connectivity](#) manufacturer:

Other Similar products are found below :

[589158040000018](#) [MDF7C-18P-2.54DSA\(55\)](#) [FCN-268F036-G/BD](#) [FCN-268M012-G/0D](#) [FCN-268M024-G/1D](#) [FCN-723J004/1](#) [MIS-048-01-F-D-DP-K](#) [832-10-034-10-001000](#) [FX4C-80S-1.27DSA](#) [93696-330](#) [224393](#) [FCN-235D050-G/C](#) [210-93-314-41-105000](#) [2-22603-0](#) [MDF7-40DP-2.54DSA\(55\)](#) [5031084030](#) [MIT-114-03-F-D-K](#) [55323-1519](#) [45970-4130](#) [YFT-20-05-H-03-SB-K](#) [503308-3040](#) [026-6203-PDB](#) [027-6203-PDB](#) [069159702701000](#) [101A10019X](#) [105061100000861+](#) [55650-0588-C](#) [75140-7012](#) [87471-650](#) [YTW-30-07-H-Q-410-140](#) [YTT-112-01-H-Q](#) [063209](#) [FCN-268F024-G0D](#) [10124054-515LF](#) [68685-603](#) [8-1616154-3](#) [MIS-019-01-F-D](#) [YTQ-12103HQ](#) [541371078](#) [IL-WX-10PB-HF-B-E1000E](#) [YFT-50-05-H-10-SB-K](#) [FCN-268M024-G/3D](#) [FCN-214J100-G/0](#) [FCN-230C068-E/S](#) [74220-001](#) [354184](#) [P50-028-DDS-TG](#) [53309-2471](#) [54546-2071](#) [1586617-1](#)