

LOC	DIST	REVISIONS					
E	B	P	LTR	DESCRIPTION	DATE	DWN	APVD
			BA	NEW RELEASE	11-NOV-08	SM	St.P

FOR FURTHER INFORMATION SEE DATA SHEET FOR  
 CRG SERIES-THICK FILM CHIP RESISTORS

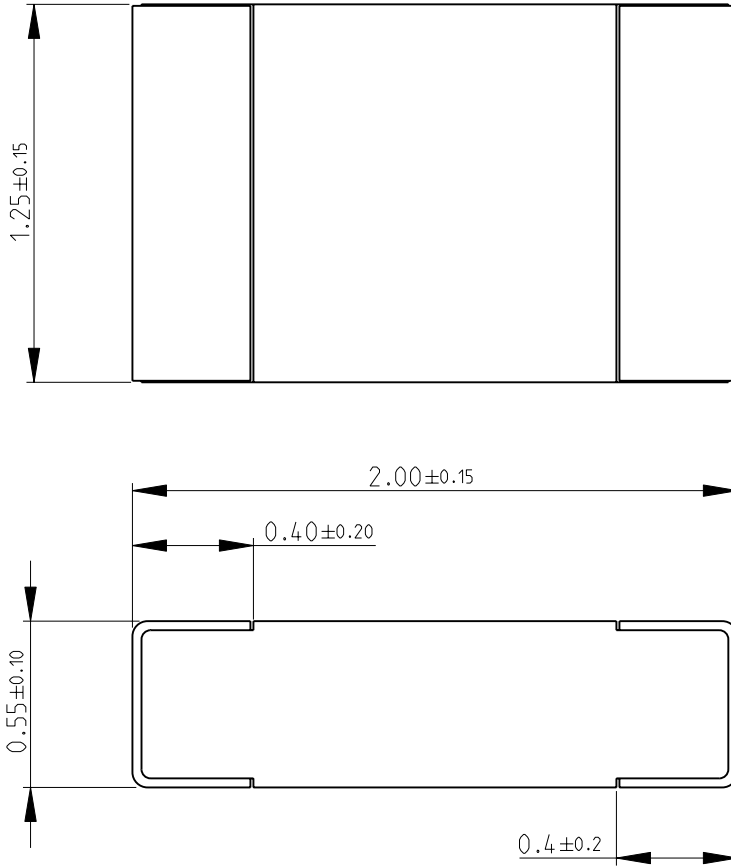

RoHS Compliant

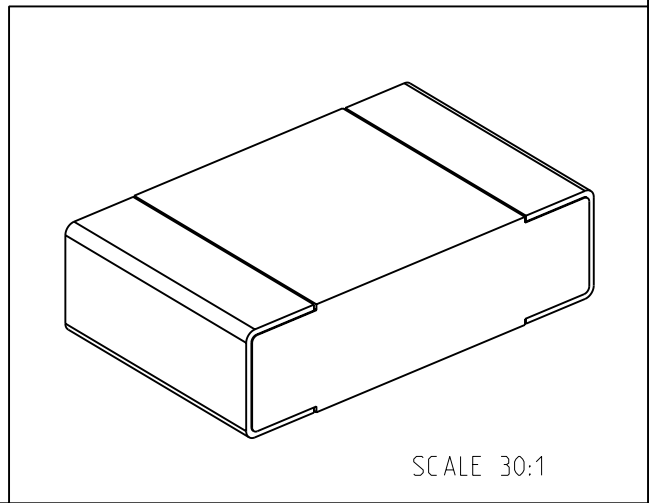

SCALE 30:1

2008

RELEASED FOR PUBLICATION

THIS DRAWING IS UNPUBLISHED.

© COPYRIGHT 2008 BY TYCO ELECTRONICS CORPORATION. ALL RIGHTS RESERVED.

DIMENSIONS: mm	DWN	11-NOV-08	MATERIAL	-	FINISH	-
	SUBHASH.M					
TOLERANCES UNLESS OTHERWISE SPECIFIED:	CHK	11-NOV-08	Tyco Electronics Corporation Dorcan, Swindon, SN3 5HH			
	PRAKASH.S					
0 PLC ±0.5	APVD	11-NOV-08	NAME THICK FILM CHIP RESISTORS SERIES CRG 0805			
1 PLC ±0.2	STEPHEN.P					
2 PLC ±0.1	PRODUCT SPEC	-	SIZE	CAGE CODE	DRAWING NO	RESTRICTED TO
3 PLC ±-	APPLICATION SPEC	-	A 4	00779	© = 1623127	-
4 PLC ±-			CUSTOMER DRAWING			
ANGLES ±5°	WEIGHT	-	SCALE	40:1	SHEET	1 OF 1
			REV BA			

## X-ON Electronics

Largest Supplier of Electrical and Electronic Components

*Click to view similar products for [Thick Film Resistors - SMD category](#):*

*Click to view products by [TE Connectivity manufacturer](#):*

Other Similar products are found below :

[CR-05FL7--19K6](#) [CR-05FL7--243R](#) [CR-05FL7--40K2](#) [CR-12FP4--324R](#) [CR-12JP4--680R](#) [CRCW06036K80FKEE](#) [M55342K06B309DRS3](#)  
[M55342K06B6E81RS3](#) [M55342K08B100DRWB](#) [M55342M05B200DRWB](#) [M55342M06B26E7RS3](#) [MC0603-511-JTW](#) [742C083750JTR](#)  
[MCR01MZPF1601](#) [MCR01MZPF1800](#) [MCR01MZPJ822](#) [MCR03EZHZ103](#) [MCR03EZPFX1272](#) [MCR10EZPF2003](#) [RC0603F1473CS](#)  
[RC0603F150CS](#) [RC1005F1152CS](#) [RC1005F1182CS](#) [RC1005F1372CS](#) [RC1005F183CS](#) [RC1005F1911CS](#) [RC1005F1912CS](#)  
[RC1005F203CS](#) [RC1005F2052CS](#) [RC1005F241CS](#) [RC1005F2431CS](#) [RC1005F3011CS](#) [RC1005F303CS](#) [RC1005F4321CS](#)  
[RC1005F4642CS](#) [RC1005F471CS](#) [RC1005F4751CS](#) [RC1005F5621CS](#) [RC1005F6041CS](#) [RC1005J106CS](#) [RC1005J121CS](#) [RC1005J122CS](#)  
[RC1005J154CS](#) [RC1005J180CS](#) [RC1005J181CS](#) [RC1005J183CS](#) [RC1005J202CS](#) [RC1005J204CS](#) [RC1005J272CS](#) [RC1005J391CS](#)