

## Type CRGCQ Series

### Key Features

Small size and light weight

Suitable for both wave and reflow soldering techniques

Supplied on tape

AEC-Q200 Compliant

7 different package sizes

Terminal finish matte Sn over Ni



TE Connectivity is pleased to introduce our AEC-Q200 compliant thick film Chip resistor, suitable for auto placement in volume and for most applications.

Available in seven different packages and supplied on tape and reel for automatic insertion processes. Standard values – E24 Series

### Characteristics – Electrical

| Type                    | CRGCQ0402      | CRGCQ0603 | CRGCQ0805 | CRGCQ1206 |
|-------------------------|----------------|-----------|-----------|-----------|
| Power Rating @ 70°C     | 0.0625W        | 0.1W      | 0.125W    | 0.25W     |
| Jumper Rated current    | 1A             | 1A        | 2A        | 2A        |
| Max. Jumper Current     | 2A             | 2A        | 5A        | 10A       |
| Max. Working Voltage    | 50V            | 75V       | 150V      | 200V      |
| Max. Overload Voltage   | 100V           | 150V      | 300V      | 400V      |
| Dielectric Withstand V. | 100V           | 300V      | 500V      | 500V      |
| Jumper resistance       | <50mΩ          |           |           |           |
| Temperature Range       | -55°C ~ +155°C |           |           |           |
| Ambient Temperature     | 70°C           |           |           |           |

| Type                    | CRGCQ1210      | CRGCQ2010 | CRGCQ2512 |
|-------------------------|----------------|-----------|-----------|
| Power Rating @ 70°C     | 0.5W           | 0.75W     | 1W        |
| Jumper Rated current    | 2A             | 2A        | 2A        |
| Max. Jumper Current     | 10A            | 10A       | 10A       |
| Max. Working Voltage    | 200V           | 200V      | 200V      |
| Max. Overload Voltage   | 500V           | 500V      | 500V      |
| Dielectric Withstand V. | 500V           | 500V      | 500V      |
| Jumper resistance       | <50mΩ          |           |           |
| Temperature Range       | -55°C ~ +155°C |           |           |
| Ambient Temperature     | 70°C           |           |           |

### Power derating curve

Power rating based on continuous load operation in ambient temperature of 70°C. For resistors operated in ambient temperatures above 70°C, power rating must be derated in accordance with this curve.

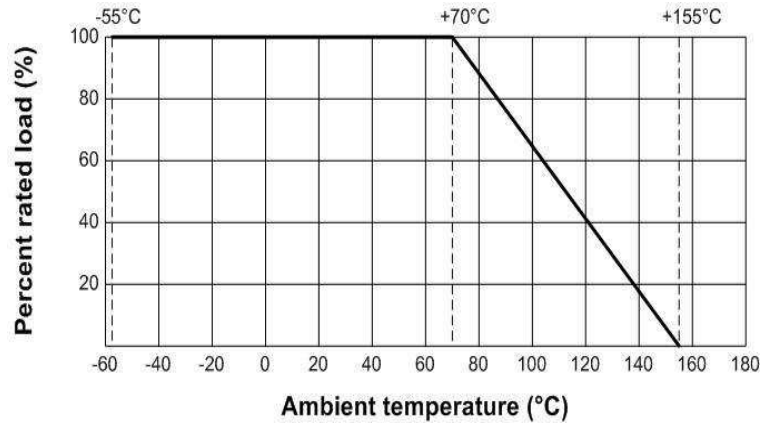

### Dimensions:

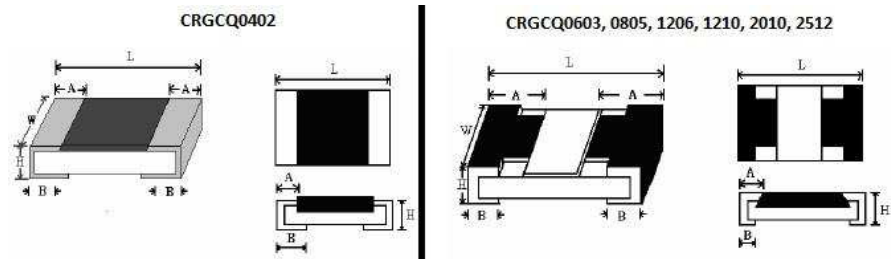

| Type      | Dimension (mm) |                    |           |           |           |
|-----------|----------------|--------------------|-----------|-----------|-----------|
|           | L              | W                  | H         | A         | B         |
| CRGCQ0402 | 1.00±0.10      | 0.50±0.05          | 0.35±0.05 | 0.20±0.10 | 0.25±0.10 |
| CRGCQ0603 | 1.60±0.10      | 0.80±0.10          | 0.45±0.10 | 0.30±0.20 | 0.30±0.20 |
| CRGCQ0805 | 2.00±0.15      | 1.25+0.15<br>-0.10 | 0.55±0.10 | 0.40±0.20 | 0.40±0.20 |
| CRGCQ1206 | 3.10±0.15      | 1.55+0.15<br>-0.10 | 0.55±0.10 | 0.45±0.20 | 0.45±0.20 |
| CRGCQ1210 | 3.10±0.10      | 2.60±0.20          | 0.55±0.10 | 0.50±0.25 | 0.50±0.20 |
| CRGCQ2010 | 5.00±0.10      | 2.50±0.20          | 0.55±0.10 | 0.60±0.25 | 0.50±0.20 |
| CRGCQ2512 | 6.35±0.10      | 3.20±0.20          | 0.55±0.10 | 0.60±0.25 | 0.50±0.20 |

**Construction:**

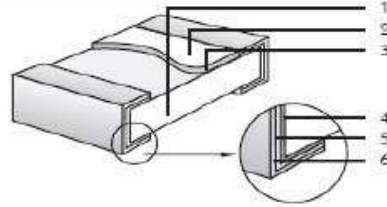

1. High purity alumina substrate
2. Protective coating
3. Resistive element
4. Termination (inner) Ni/Cr
5. Termination (between) Ni Barrier
6. Termination (outer) Sn

**Power Rating and Resistance Range:**

| Type      | Power Rating @ 70°C | Tolerance | Resistance Range | Standard Series           |
|-----------|---------------------|-----------|------------------|---------------------------|
| CRGCQ0402 | 0.0625W             | Jumper    | < 50mΩ           | E24<br>E96 by negotiation |
|           |                     | ±1%       | 10R – 1M         |                           |
|           |                     | ±5%       | 1R0 – 10M        |                           |
| CRGCQ0603 | 0.1W                | Jumper    | < 50mΩ           | E24<br>E96 by negotiation |
|           |                     | ±1%       | 10R – 1M         |                           |
|           |                     | ±5%       | 1R0 – 10M        |                           |
| CRGCQ0805 | 0.125W              | Jumper    | < 50mΩ           | E24<br>E96 by negotiation |
|           |                     | ±1%       | 10R – 1M         |                           |
|           |                     | ±5%       | 1R0 – 10M        |                           |
| CRGCQ1206 | 0.25W               | Jumper    | < 50mΩ           | E24<br>E96 by negotiation |
|           |                     | ±1%       | 10R – 1M         |                           |
|           |                     | ±5%       | 1R0 – 10M        |                           |
| CRGCQ1210 | 0.5W                | Jumper    | < 50mΩ           | E24<br>E96 by negotiation |
|           |                     | ±1%       | 10R – 1M         |                           |
|           |                     | ±5%       | 1R0 – 10M        |                           |
| CRGCQ2010 | 0.75W               | Jumper    | < 50mΩ           | E24<br>E96 by negotiation |
|           |                     | ±1%       | 10R – 1M         |                           |
|           |                     | ±5%       | 1R0 – 10M        |                           |
| CRGCQ2512 | 1W                  | Jumper    | < 50mΩ           | E24<br>E96 by negotiation |
|           |                     | ±1%       | 10R – 1M         |                           |
|           |                     | ±5%       | 1R0 – 10M        |                           |



- Marking for E96 series 0603 size with no marking code marked as per E24 values.

**Performance Specification**

| Characteristics              | Limits                                                                         | Test Methods                                                                                                                                                                                                                         |
|------------------------------|--------------------------------------------------------------------------------|--------------------------------------------------------------------------------------------------------------------------------------------------------------------------------------------------------------------------------------|
| Load life                    | ±1%: ±(1.0%+0.1Ω)Max.<br>±5%: ±(3.0%+0.1Ω)Max.                                 | 125°C, 35% power, at RCWV or Max. Working Voltage whichever less, 1,000 hours (1.5 hours “ON”, 0.5hours“OFF”), Measurement at 24±2 hours after test conclusion. (MIL-STD-202 Method 108)                                             |
| Temperature coefficient      | 1Ω ≤ R ≤ 10Ω: ±400PPM/°C<br>10Ω < R ≤ 100Ω: ±200PPM/°C<br>R > 100Ω: ±100PPM/°C | Measure between -55°C ~ +125°C                                                                                                                                                                                                       |
| Short-time overload          | ±1%: ±(1.0%+0.1Ω) Max<br>±5%: ±(2.0%+0.1Ω) Max                                 | 2.5x Rated voltage or Max. Overload Voltage whichever is lower for 5 seconds, then check the resistance.                                                                                                                             |
| Terminal Bending             | ±(1.0%+0.05Ω) Max                                                              | Bending Distance 3mm, Duration: 60s±5s, then check the resistance                                                                                                                                                                    |
| Solderability                | 95% coverage Min.                                                              | 245±3°C; 2~3s                                                                                                                                                                                                                        |
| Soldering heat               | ±(1.0%+0.05Ω) Max                                                              | 260±5°C; 10±1s                                                                                                                                                                                                                       |
| Moisture Resistance          | 1%: ± (0.5%+0.1Ω) Max.<br>5%: ± (3.0%+0.1Ω) Max.                               | 25°C~65°C, 90~100%RH, 2.5Hr; 65°C 90~100%RH, 3Hr; 65°C~25°C 80~100%RH, 2.5Hr, 10 cycles, Measurement at 24 hours after test conclusion (MIL-STD-202 Method 106)                                                                      |
| Biased Humidity              | 1%: ± (1.0%+0.1Ω) Max.<br>5%: ± (3.0%+0.1Ω) Max.                               | 10% rated power, 85°C/85%RH, 1000Hr. Measurement at 24 hours after test conclusion. (MIL-STD-202 Method 103)                                                                                                                         |
| Dielectric Withstand Voltage | No evidence of flashover, mechanical damage, arcing or insulation breakdown    | Resistor shall be clamped in the trough of 90° metallic V-block and shall be tested at AC potential respectively specified in the given list of each product type for 60~70s.                                                        |
| Temperature cycling          | 1%: ± (0.5%+0.1Ω) Max.<br>5%: ± (1.0%+0.1Ω) Max                                | -55±3°C 30min ~normal temperature 10min-15min~155±2°C 30min~normal temperature 10min-15min1000 cycles. Measurement at 24 hours after test conclusion. (JESD22 Method JA-104)                                                         |
| ESD                          | ±(1.0%+0.05Ω) Max                                                              | With the electrometer in direct contact with the discharge tip, verify the voltage setting at levels of ±500V, ±1KV, ±2KV, ±4KV, ±8KV, The electrometer reading shall be within ±10% for voltages from 500V to ≤800V. (AEC-Q200-002) |
| Sulfuration test             | 1%: ± (1.0%+0.1Ω) Max.<br>5%: ± (5.0%+0.1Ω) Max.                               | H2S 3~5PPM 50°C±2°C 91%~93% RH 1000H                                                                                                                                                                                                 |

### Packaging Specification

Paper taping

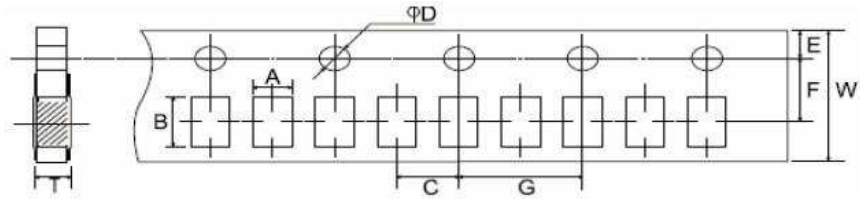

| Type | A ±  | B ±  | C ± | ØD +0.1<br>-0 | E ±  | F ± | G ± | W ±  | T ±  |
|------|------|------|-----|---------------|------|-----|-----|------|------|
| 0402 | 0.65 | 1.15 | 2.0 | 1.5           | 1.75 | 3.5 | 4.0 | 8.0  | 0.45 |
| 0603 | 1.10 | 1.90 | 2.0 | 1.5           | 1.75 | 3.5 | 4.0 | 8.0  | 0.67 |
| 0805 | 1.65 | 2.40 | 2.0 | 1.5           | 1.75 | 3.5 | 4.0 | 8.0  | 0.81 |
| 1206 | 2.00 | 3.60 | 2.0 | 1.5           | 1.75 | 3.5 | 4.0 | 8.0  | 0.81 |
| 1210 | 2.80 | 3.50 | 2.0 | 1.5           | 1.75 | 3.5 | 4.0 | 8.0  | 0.75 |
| 2010 | 2.80 | 5.40 | 2.0 | 1.5           | 1.75 | 5.5 | 4.0 | 12.0 | 0.75 |

Embossed Taping

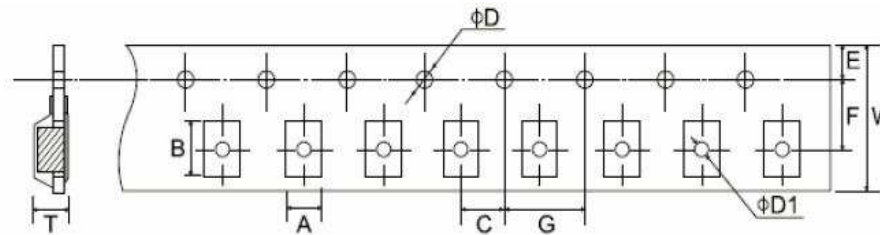

| Type | A ±  | B ±  | C ± | ØD +0.1<br>-0 | ØD1 +0.1<br>-0 | E ±  | F ± | G ± | W ±  | T ± |
|------|------|------|-----|---------------|----------------|------|-----|-----|------|-----|
| 2512 | 3.50 | 6.70 | 2.0 | 1.5           | 1.5            | 1.75 | 5.5 | 4.0 | 12.0 | 1.0 |

Peeling strength of cover tape:

Test condition: 0.1 to 0.7 N at a peel off speed of 300mm / min.

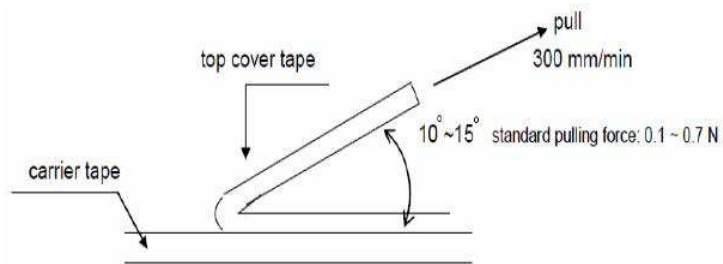

Reel Dimensions (mm):

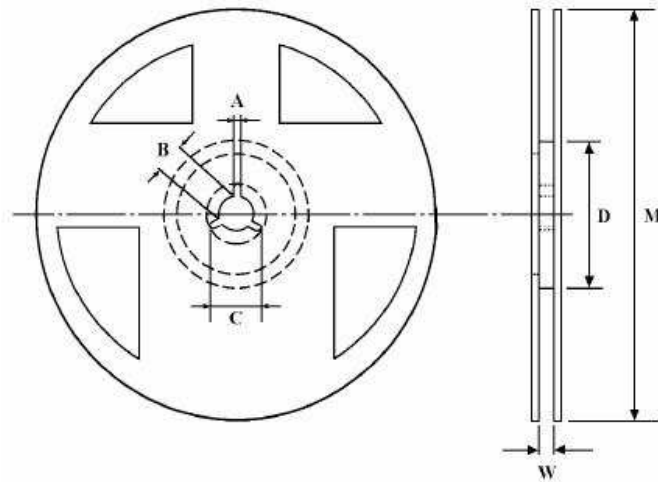

| Type | Tape     | Reel Qty | A ± 0.5 | B ± 0.5 | C ± 0.5 | D ± 1 | M ± 2 | W ± 1 |
|------|----------|----------|---------|---------|---------|-------|-------|-------|
| 0402 | Paper    | 10,000   | 2       | 13      | 21      | 60    | 178   | 10    |
| 0603 | Paper    | 5,000    | 2       | 13      | 21      | 60    | 178   | 10    |
| 0805 | Paper    | 5,000    | 2       | 13      | 21      | 60    | 178   | 10    |
| 1206 | Paper    | 5,000    | 2       | 13      | 21      | 60    | 178   | 10    |
| 1210 | Paper    | 5,000    | 2       | 13      | 21      | 60    | 178   | 10    |
| 2010 | Paper    | 4,000    | 2       | 13      | 21      | 60    | 178   | 13.8  |
| 2512 | Embossed | 4,000    | 2       | 13      | 21      | 60    | 178   | 13.8  |

**Label:**

- A. TE Product Number
- B. Product Description
- C. Quantity
- D. Lot Number
- E. RoHS Statement

Example:

|                                                                                      |                    |      |
|--------------------------------------------------------------------------------------|--------------------|------|
| TYCO Pn                                                                              | CRGCQ0603F100R     |      |
| DESC                                                                                 | CRGCQ 0603 100R 1% |      |
| QTY                                                                                  | 5000 Pcs.          | PPM: |
| LOT                                                                                  | SAMPLE             |      |
| REF                                                                                  | RoHS 2011/65/EU    |      |
|  |                    |      |

### **Environment Related Substance**

This product complies to EU RoHS directive, EU PAHs directive, EU PFOS directive and Halogen free.

### **Ozone layer depleting substances.**

Ozone depleting substances are not used in our manufacturing process of this product.

This product is not manufactured using Chloro fluorocarbons (CFCs), Hydrochlorofluorocarbons (HCFCs), Hydrobromofluorocarbons (HBFCs) or other ozone depleting substances in any phase of the manufacturing process.

### **Storage Condition**

The performance of these products, including the solderability, is guaranteed for a year from the date of arrival at your company, provided that they remain packed as they were when delivered and stored at a temperature of  $25^{\circ}\text{C} \pm 10^{\circ}\text{C}$  and a relative humidity of  $60\%RH \pm 10\%RH$ , chemical and dust free atmosphere

Even within the above guarantee periods, do not store these products in the following conditions otherwise, their electrical performance and/or solderability may be deteriorated, and the packaging materials (e.g. taping materials) may be deformed or deteriorated, resulting in mounting failures.

1. In salty air or in air with a high concentration of corrosive gas, such as  $\text{Cl}_2$ ,  $\text{H}_2\text{S}$ ,  $\text{NH}_3$ ,  $\text{SO}_2$ , or  $\text{NO}_2$
2. In direct sunlight

### **Solder Profile**

#### **Wave soldering condition: (2 cycles Max.)**

Pre-heat :  $100 \sim 120^{\circ}\text{C}$ ,  $30 \pm 5$  sec.

Peak temp.:  $260^{\circ}\text{C}$



**Reflow soldering condition: (2 cycles Max.)**

Pre-heat : 150 ~ 180 °C, 90 ~ 120 sec.

Suggestion solder temp.: 235 ~ 255 °C, 20 ~ 40 sec.

Peak temp.: 260 °C

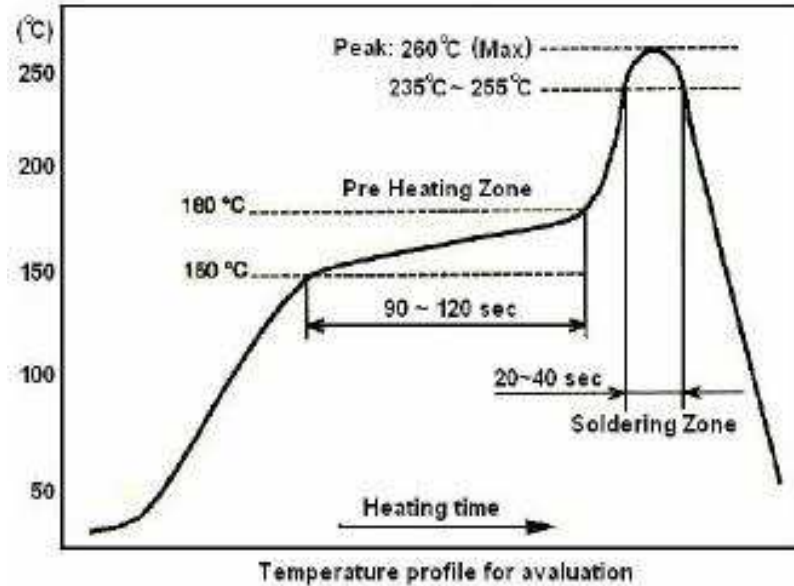

**Hand Soldering condition:** The Soldering iron tip should be less than 300°C and maximum contact time should be 5 seconds

**How To Order**

| CRGCQ                                               | 0603 | J                     | 10K                |
|-----------------------------------------------------|------|-----------------------|--------------------|
| Common Part                                         | Size | Tolerance             | Resistance Value   |
| CRGCQ – AEC-Q200 compliant Thick Film Chip Resistor | 0402 | F - ±1%<br>J - ±5%    | 1 ohm (1Ω) 1R0     |
|                                                     | 0603 |                       | 1K ohm (1000Ω) 1K0 |
|                                                     | 0805 |                       | 100K ohm (100000Ω) |
|                                                     | 1206 |                       | 100K               |
|                                                     | 1210 |                       |                    |
|                                                     | 2010 |                       |                    |
| 2512                                                |      | 1M ohm (1000000Ω) 1M0 |                    |

## X-ON Electronics

Largest Supplier of Electrical and Electronic Components

*Click to view similar products for [Thick Film Resistors - SMD category](#):*

*Click to view products by [TE Connectivity manufacturer](#):*

Other Similar products are found below :

[CR-05FL7--150R](#) [CR-05FL7--698K](#) [CR-12FP4--324R](#) [CR-12JP4--680R](#) [CRCW04021K20FKEE](#) [CRCW06032K10FKEC](#)  
[CRCW06036K80FKEE](#) [M55342K06B10D0RS6](#) [M55342K06B14E0RS6](#) [M55342K06B1E78RS3](#) [M55342K06B24E9RS6](#)  
[M55342K06B6E19RWL](#) [M55342K06B6E81RS3](#) [M55342M05B200DRWB](#) [M55342M06B4K70MS3](#) [742C083750JTR](#) [MCR01MZPF1202](#)  
[MCR01MZPF1800](#) [MCR01MZPF6201](#) [MCR01MZPF9102](#) [MCR01MZPJ121](#) [MCR01MZPJ125](#) [MCR01MZPJ751](#) [MCR03EZHJ103](#)  
[MCR03EZPF2004](#) [MCR03EZPJ270](#) [MCR03EZPJ821](#) [MCR10EZPF1102](#) [MCR10EZPF2700](#) [MCR18EZPJ330](#) [RC1005F1152CS](#)  
[RC1005F1182CS](#) [RC1005F1372CS](#) [RC1005F183CS](#) [RC1005F1911CS](#) [RC1005F1912CS](#) [RC1005F203CS](#) [RC1005F2052CS](#)  
[RC1005F241CS](#) [RC1005F2431CS](#) [RC1005F3011CS](#) [RC1005F303CS](#) [RC1005F4321CS](#) [RC1005F4642CS](#) [RC1005F471CS](#)  
[RC1005F4751CS](#) [RC1005F5621CS](#) [RC1005F6041CS](#) [RC1005J106CS](#) [RC1005J121CS](#)