

Type CRGH Series

Key Features

Thick Film Resistors with high power to size ratio, ideally suited to industrial and general purpose use

Value range from 1Ω to 10MΩ

Seven package sizes

Terminal finish matte Sn over Ni

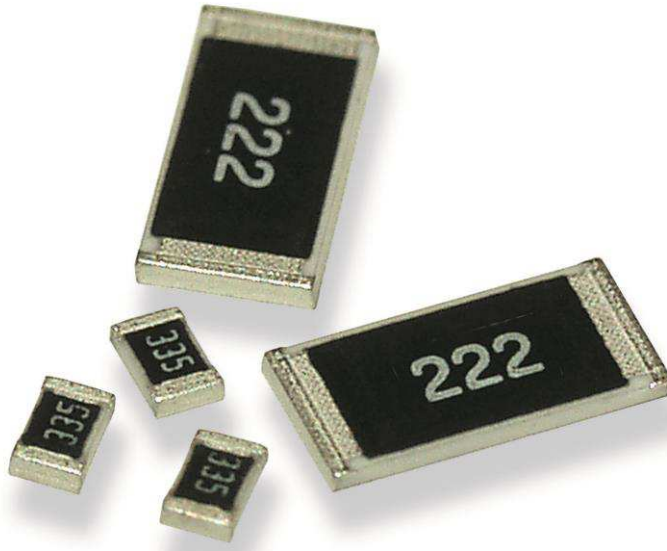

The resistive element is screen printed and fired, and a passivation layer added. Each resistor is trimmed to tolerance by laser. The pre-scribed tile is then broken into strips, the end plating fired on, and the strips broken into individual components. Final termination finish is electroplated matte Sn over a Ni barrier layer.

Characteristics – Electrical

| Size | 0402 | 0603 | 0805 | 1206 | 1210 | 2010 | 2512 |
|---------------------------|---------------|-----------|-----------|-----------|-----------|-----------|-----------|
| Power Rating (W) @70°C | 0.1 | 0.2 | 0.33 | 0.5 | 0.75 | 1 | 2 |
| Resistance Range | 1R0 ~ 10M | R10 ~ 10M | R10 ~ 10M | R10 ~ 10M | R10 ~ 10M | R10 ~ 10M | R10 ~ 10M |
| Tolerance | 1% 5% | | | | | | |
| Max. Working Voltage (V) | 50 | 50 | 150 | 200 | 200 | 200 | 250 |
| Max. Overload Voltage (V) | 100 | 100 | 300 | 400 | 500 | 500 | 500 |
| Dielectric strength | 100 | 300 | 500 | 500 | 500 | 500 | 500 |
| Temperature Range | -55°C ~ 155°C | | | | | | |

Power Rating:

Resistors shall have a power rating based on continuous load operation at an ambient temperature of 70 °C . For temperature in excess of 70 °C , The load shall be derated as shown below:



Voltage Rating

Resistors shall have a rated direct-current (DC) continuous working voltage or an approximate sine-wave root-mean-square (RMS) alternating-current (AC) continuous working voltage at commercial-line frequency and waveform corresponding to the power rating, as determined from the following formula:

$$RCWV = \sqrt{P \times R}$$

Where:

RCWV = Rated DC or RMS AC continuous working voltage at commercial-line frequency and waveform (volt)

P = Power Rating (watt)

R = Nominal Resistance (ohm)

In no case shall the rated DC or RMS AC continuous working voltage be greater than the applicable maximum value.

Construction:

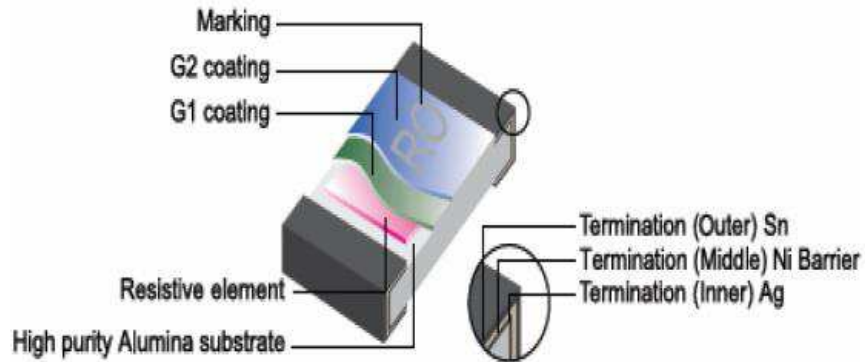

Dimensions:

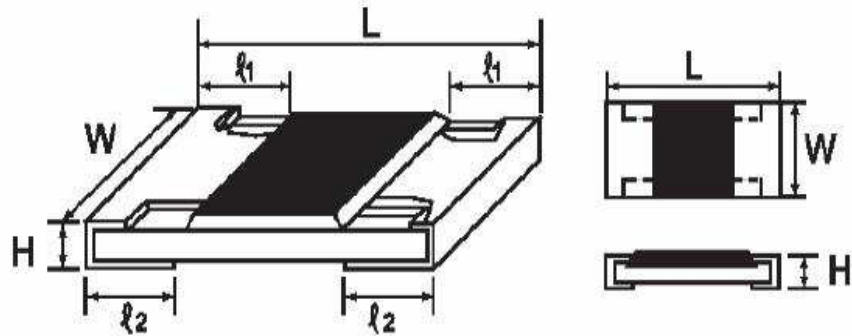

| Type | Dimensions (mm) | | | | |
|----------|-----------------|--|------------|------------|------------|
| | L | W | H | ℓ1 | ℓ2 |
| CRGH0402 | 1.00 ±0.10 | 0.50 ±0.05 | 0.35 ±0.05 | 0.20 ±0.10 | 0.25 ±0.10 |
| CRGH0603 | 1.60 ±0.10 | 0.80 ±0.10 | 0.45 ±0.10 | 0.30 ±0.20 | 0.30 ±0.20 |
| CRGH0805 | 2.00 ±0.15 | 1.25 ^{+0.15} _{-0.10} | 0.55 ±0.10 | 0.40 ±0.20 | 0.40 ±0.20 |
| CRGH1206 | 3.10 ±0.15 | 1.55 ^{+0.15} _{-0.10} | 0.55 ±0.10 | 0.45 ±0.20 | 0.45 ±0.20 |
| CRGH1210 | 3.10 ±0.10 | 2.60 ±0.20 | 0.55 ±0.10 | 0.50 ±0.20 | 0.50 ±0.20 |
| CRGH2010 | 5.00 ±0.10 | 2.50 ±0.20 | 0.55 ±0.10 | 0.60 ±0.25 | 0.50 ±0.20 |
| CRGH2512 | 6.35 ±0.10 | 3.20 ±0.20 | 0.55 ±0.10 | 0.60 ±0.25 | 0.50 ±0.20 |

Performance Specification

| Characteristic | Limits | Test Methods (JIS C 5201-1) | | | | | | | | | | | | | | | |
|------------------------------|---|---|------|-------------|------|---|---|---------|---|------------|------------|---|--|---------|---|------------|------------|
| Dielectric Withstand Voltage | No evidence of flashover mechanical damage, arcing or insulation break down | 4.7 Clamped in the trough of a 90°C metallic v-block and shall be tested at ac potential respectively specified in the type for 60-70 seconds | | | | | | | | | | | | | | | |
| Temperature Coefficient | $0.1\Omega \leq R \leq 0.976\Omega \pm 100$ (CRGH0603 = ± 200) $1\Omega \sim 10\Omega: \pm 200\text{PPM}/^\circ\text{C}$ $10.1\Omega \sim 10\text{M}\Omega: \pm 100\text{PPM}/^\circ\text{C}$ CRGH0402: $1\Omega \sim 10\Omega: \pm 400\text{PPM}/^\circ\text{C}$ $10.1\Omega \sim 100\Omega: \pm 200\text{PPM}/^\circ\text{C}$ $>100\Omega: \pm 100\text{PPM}/^\circ\text{C}$ | 4.8 Natural resistance change per temp. degree centigrade $R2 - R1$ $\text{-----} \times 10^6 \text{ (PPM}/^\circ\text{C)}$ $R1(t2-t1)$ R1: Resistance value at room temperature (T1) R2: Resistance value at room temp. plus 100 °C(T2) Test pattern: room temp. (T1), room temp. +100°C(T2) | | | | | | | | | | | | | | | |
| Short time overload | Resistance change rate is $\pm 5\%$ ($2.0\% + 0.1\Omega$) Max. $\pm 1\%$ ($1.0\% + 0.1\Omega$) Max. | 4.13 Permanent resistance change after the application of a potential of 2.5 times RCWV for 5 seconds | | | | | | | | | | | | | | | |
| Solderability | 95 % coverage Min. | Wave Solder: Test temperature of solder: $245^\circ\text{C} \pm 3^\circ\text{C}$ dipping time in solder : 2-3 seconds.  | | | | | | | | | | | | | | | |
| Soldering heat | Resistance change rate is: $\pm (1.0\% + 0.05\Omega)$ Max. | 4.18 Dip the resistor into a solder bath having a temperature of $260^\circ\text{C} \pm 3^\circ\text{C}$ and hold it for 10 ± 1 seconds. | | | | | | | | | | | | | | | |
| Temperature cycling | Resistance change rate is $\pm 5\%$ ($1.0\% + 0.05\Omega$) Max. $\pm 1\%$ ($0.5\% + 0.05\Omega$) Max. | 4.19 Resistance change after continuous 5 cycles for duty cycle specified below : <table border="1" style="margin-left: 20px;"> <thead> <tr> <th>Step</th> <th>Temperature</th> <th>Time</th> </tr> </thead> <tbody> <tr> <td>1</td> <td>$-55^\circ\text{C} \pm 3^\circ\text{C}$</td> <td>30 mins</td> </tr> <tr> <td>2</td> <td>Room temp.</td> <td>10~15 mins</td> </tr> <tr> <td>3</td> <td>$+155^\circ\text{C} \pm 2^\circ\text{C}$</td> <td>30 mins</td> </tr> <tr> <td>4</td> <td>Room temp.</td> <td>10~15 mins</td> </tr> </tbody> </table> | Step | Temperature | Time | 1 | $-55^\circ\text{C} \pm 3^\circ\text{C}$ | 30 mins | 2 | Room temp. | 10~15 mins | 3 | $+155^\circ\text{C} \pm 2^\circ\text{C}$ | 30 mins | 4 | Room temp. | 10~15 mins |
| Step | Temperature | Time | | | | | | | | | | | | | | | |
| 1 | $-55^\circ\text{C} \pm 3^\circ\text{C}$ | 30 mins | | | | | | | | | | | | | | | |
| 2 | Room temp. | 10~15 mins | | | | | | | | | | | | | | | |
| 3 | $+155^\circ\text{C} \pm 2^\circ\text{C}$ | 30 mins | | | | | | | | | | | | | | | |
| 4 | Room temp. | 10~15 mins | | | | | | | | | | | | | | | |
| Humidity | Resistance change rate is $\pm 5\%$ ($3.0\% + 0.1\Omega$) Max. $\pm 1\%$ ($0.5\% + 0.1\Omega$) Max. | 4.24 Temporary resistance change after 240 hours exposure in a humidity test chamber controlled at $40 \pm 2^\circ\text{C}$ and 90-95% relative humidity | | | | | | | | | | | | | | | |
| Load life in humidity | Resistance change rate is $\pm 5\%$ ($3.0\% + 0.1\Omega$) Max. $\pm 1\%$ ($1.0\% + 0.1\Omega$) Max. | 7.9 Resistance change after 1,000 hours (1.5 hours "on", 0.5 hour "off") at RCWV in a humidity chamber controlled at $40^\circ\text{C} \pm 2^\circ\text{C}$ and 90 to 95 % relative humidity | | | | | | | | | | | | | | | |



Performance Specification (continued)

| Characteristic | Limits | Test Methods (JIS C 5201-1) |
|------------------|--|---|
| Load Life | Resistance change rate is $\pm 5\%$ ($3.0\% + 0.1\Omega$) Max. $\pm 1\%$ ($1.0\% + 0.1\Omega$) Max. | 4.25.1 Permanent resistance change after 1,000 hours operating at RCWV, with duty cycle of (1.5 hours"on", 0.5 hour"off") at $70^{\circ}\text{C} \pm 2^{\circ}\text{C}$ ambient |
| Terminal bending | Resistance change rate is $\pm (1.0\% + 0.05\Omega)$ Max. | 4.33 Twist of Test Board: Y/X = 3/90 mm for 60 seconds |

Marking

E24 series 0603 – 2512 3 Digits – first two digits denote significant figures of resistance and third digit denotes number of zeros thereafter. EG

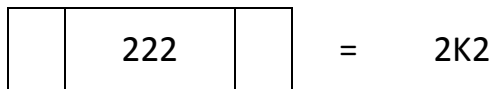

Marking for E96 Series 0805 – 2512 4 digits – First three digits denote significant figures of resistance and fourth digit denotes number of zeros thereafter. EG.

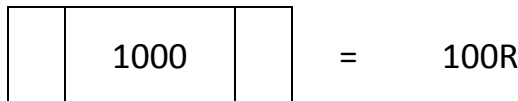

For ohmic values below 100R letter "R" denotes decimal point. EG

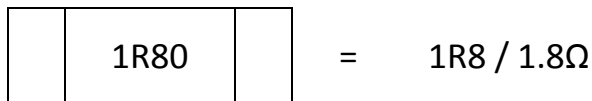

0402 size chips are not marked

0603 E96 3 digit marking.

Resistance Code from table on next page, and Multiplier code from table below

Multiplier Code

| Code | A | B | C | D | E | F | G | H | X | Y | Z |
|-------|--------|--------|--------|--------|--------|--------|--------|--------|-----------|-----------|-----------|
| Mult. | 10^0 | 10^1 | 10^2 | 10^3 | 10^4 | 10^5 | 10^6 | 10^7 | 10^{-1} | 10^{-2} | 10^{-3} |

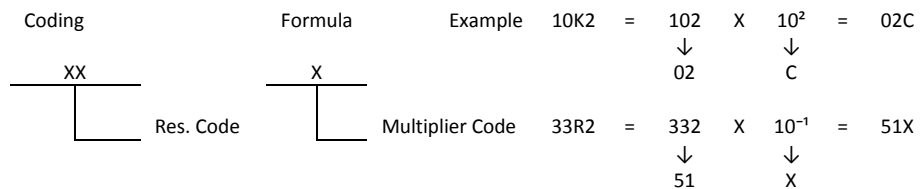

Resistance Code

| Value | Code | Value | Code | Value | Code | Value | Code | Value | Code |
|-------|------|-------|------|-------|------|-------|------|-------|------|
| 100 | 01 | 162 | 21 | 261 | 41 | 422 | 61 | 681 | 81 |
| 102 | 02 | 165 | 22 | 267 | 42 | 432 | 62 | 698 | 82 |
| 105 | 03 | 169 | 23 | 274 | 43 | 442 | 63 | 715 | 83 |
| 107 | 04 | 174 | 24 | 280 | 44 | 453 | 64 | 732 | 84 |
| 110 | 05 | 178 | 25 | 287 | 45 | 464 | 65 | 750 | 85 |
| 113 | 06 | 182 | 26 | 294 | 46 | 475 | 66 | 768 | 86 |
| 115 | 07 | 187 | 27 | 301 | 47 | 487 | 67 | 787 | 87 |
| 118 | 08 | 191 | 28 | 309 | 48 | 499 | 68 | 806 | 88 |
| 121 | 09 | 196 | 29 | 316 | 49 | 511 | 69 | 825 | 89 |
| 124 | 10 | 200 | 30 | 324 | 50 | 523 | 70 | 845 | 90 |
| 127 | 11 | 205 | 31 | 332 | 51 | 536 | 71 | 866 | 91 |
| 130 | 12 | 210 | 32 | 340 | 52 | 549 | 72 | 887 | 92 |
| 133 | 13 | 215 | 33 | 348 | 53 | 562 | 73 | 909 | 93 |
| 137 | 14 | 221 | 34 | 357 | 54 | 576 | 74 | 931 | 94 |
| 140 | 15 | 226 | 35 | 365 | 55 | 590 | 75 | 953 | 95 |
| 143 | 16 | 232 | 36 | 374 | 56 | 604 | 76 | 976 | 96 |
| 147 | 17 | 237 | 37 | 383 | 57 | 619 | 77 | | |
| 150 | 18 | 243 | 38 | 392 | 58 | 634 | 78 | | |
| 154 | 19 | 249 | 39 | 402 | 59 | 649 | 79 | | |
| 158 | 20 | 255 | 40 | 412 | 60 | 665 | 80 | | |

Label

Label shall be marked with the following item :

- A. Nominal Resistance and Resistance Tolerance
- B. Power Rating and Size
- C. Quantity and description
- D. Part No.
- E. Lot No.
- Ex.



Packing Specification:

Tape dimensions (mm)

A. Paper Taping



| Type | A±0.2 | B±0.2 | C±0.05 | ØD+0.1 -0 | E±0.1 | F±0.05 | G±0.1 | W±0.2 | T±0.1 |
|------|-------|-------|--------|--------------|-------|--------|-------|-------|-------|
| 0402 | 0.65 | 1.15 | 2.0 | 1.5 | 1.75 | 3.5 | 4.0 | 8.0 | 0.45 |



| Type | A±0.2 | B±0.2 | C±0.05 | ØD+0.1 -0 | E±0.1 | F±0.05 | G±0.1 | W±0.2 | T±0.1 |
|------|-------|-------|--------|--------------|-------|--------|-------|-------|-------|
| 0603 | 1.10 | 1.90 | 2.0 | 1.5 | 1.75 | 3.5 | 4.0 | 8.0 | 0.67 |
| 0805 | 1.65 | 2.40 | 2.0 | 1.5 | 1.75 | 3.5 | 4.0 | 8.0 | 0.81 |
| 1206 | 2.00 | 3.60 | 2.0 | 1.5 | 1.75 | 3.5 | 4.0 | 8.0 | 0.81 |
| 1210 | 2.80 | 3.50 | 2.0 | 1.5 | 1.75 | 3.5 | 4.0 | 8.0 | 0.75 |

B. Embossed Taping

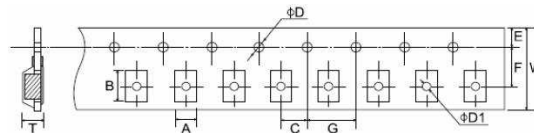

| Type | A ±0.2 | B ±0.2 | C ±0.05 | ØD+0.1 -0 | ØD1+0.1 -0 | E ±0.1 | F ±0.05 | G ±0.1 | W ±0.2 | T ±0.1 |
|------|-----------|-----------|------------|--------------|---------------|-----------|------------|-----------|-----------|-----------|
| 2010 | 2.90 | 5.60 | 2.0 | 1.5 | 1.5 | 1.75 | 5.5 | 4.0 | 12.0 | 1.0 |
| 2512 | 3.50 | 6.70 | 2.0 | 1.5 | 1.5 | 1.75 | 5.5 | 4.0 | 12.0 | 1.0 |

* Peeling Strength of Top Cover Tape

Test Condition: 0.1 to 0.7 N at a peel-off speed of 300 mm / min.



Reel Dimension (mm)



| Type | Taping | Reel Quantity | A ±0.5 | B ±0.5 | C ±0.5 | D ±1 | M ±1 | W ±1 |
|------|----------|---------------|--------|--------|--------|------|------|------|
| 0402 | Paper | 10,000 | 2 | 13 | 21 | 60 | 178 | 10 |
| 0603 | Paper | 5,000 | 2 | 13 | 21 | 60 | 178 | 10 |
| 0805 | Paper | 5,000 | 2 | 13 | 21 | 60 | 178 | 10 |
| 1206 | Paper | 5,000 | 2 | 13 | 21 | 60 | 178 | 10 |
| 1210 | Paper | 5,000 | 2 | 13 | 21 | 60 | 178 | 10 |
| 2010 | Embossed | 4,000 | 2 | 13 | 21 | 60 | 178 | 13.8 |
| 2512 | Embossed | 4,000 | 2 | 13 | 21 | 60 | 178 | 13.8 |

How To Order

| CRGH | 0603 | J | 10K |
|--|------|--------------------|-------------------------|
| Common Part | Size | Tolerance | Resistance Value |
| CRGH - High Power Thick Film Chip Resistor | 0402 | F - ±1% J - ±5% | 1 ohm (1Ω) 1R0 |
| | 0603 | | 1K ohm (1000Ω) 1K0 |
| | 0805 | | 100K ohm (100000Ω) 100K |
| | 1206 | | |
| | 1210 | | |
| | 2010 | | |
| | 2512 | | 1M ohm (1000000Ω) 1M0 |

X-ON Electronics

Largest Supplier of Electrical and Electronic Components

Click to view similar products for [Thick Film Resistors - SMD category:](#)

Click to view products by [TE Connectivity manufacturer:](#)

Other Similar products are found below :

[CR-05FL7--19K6](#) [CR-05FL7--243R](#) [CR-05FL7--40K2](#) [CR-12FP4--324R](#) [CR-12JP4--680R](#) [CRCW06036K80FKEE](#) [M55342K06B309DRS3](#)
[M55342K06B6E81RS3](#) [M55342K08B100DRWB](#) [M55342M05B200DRWB](#) [M55342M06B26E7RS3](#) [MC0603-511-JTW](#) [742C083750JTR](#)
[MCR01MZPF1601](#) [MCR01MZPF1800](#) [MCR01MZPJ822](#) [MCR03EZHZ103](#) [MCR03EZPFX1272](#) [MCR10EZPF2003](#) [RC0603F1473CS](#)
[RC0603F150CS](#) [RC1005F1152CS](#) [RC1005F1182CS](#) [RC1005F1372CS](#) [RC1005F183CS](#) [RC1005F1911CS](#) [RC1005F1912CS](#)
[RC1005F203CS](#) [RC1005F2052CS](#) [RC1005F241CS](#) [RC1005F2431CS](#) [RC1005F3011CS](#) [RC1005F303CS](#) [RC1005F4321CS](#)
[RC1005F4642CS](#) [RC1005F471CS](#) [RC1005F4751CS](#) [RC1005F5621CS](#) [RC1005F6041CS](#) [RC1005J106CS](#) [RC1005J121CS](#) [RC1005J122CS](#)
[RC1005J154CS](#) [RC1005J180CS](#) [RC1005J181CS](#) [RC1005J183CS](#) [RC1005J202CS](#) [RC1005J204CS](#) [RC1005J272CS](#) [RC1005J391CS](#)