

Type CRGH Series

Key Features

Thick Film Resistors with high power to size ratio, ideally suited to industrial and general purpose use

Value range from 1Ω to 10MΩ

Seven package sizes

Terminal finish matte Sn over Ni

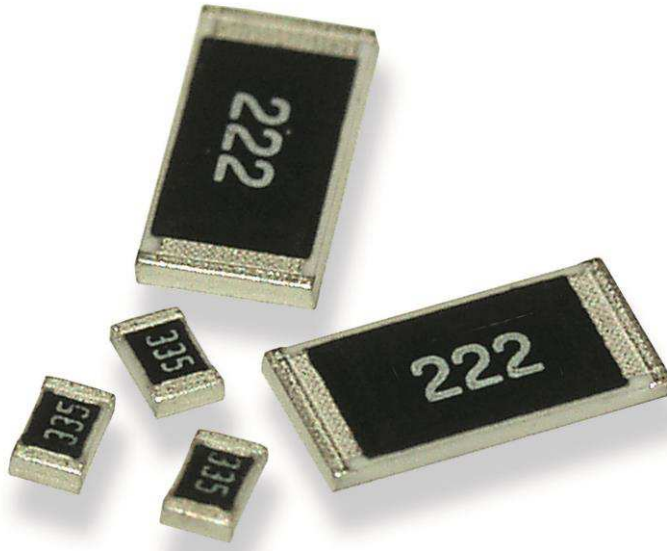

The resistive element is screen printed and fired, and a passivation layer added. Each resistor is trimmed to tolerance by laser. The pre-scribed tile is then broken into strips, the end plating fired on, and the strips broken into individual components. Final termination finish is electroplated matte Sn over a Ni barrier layer.

Characteristics – Electrical

Size	0402	0603	0805	1206	1210	2010	2512
Power Rating (W) @70°C	0.1	0.2	0.33	0.5	0.75	1	2
Resistance Range	1R0 ~ 10M	R10 ~ 10M	R10 ~ 10M	R10 ~ 10M	R10 ~ 10M	R10 ~ 10M	R10 ~ 10M
Tolerance	1% 5%						
Max. Working Voltage (V)	50	50	150	200	200	200	250
Max. Overload Voltage (V)	100	100	300	400	500	500	500
Dielectric strength	100	300	500	500	500	500	500
Temperature Range	-55°C ~ 155°C						

Power Rating:

Resistors shall have a power rating based on continuous load operation at an ambient temperature of 70 °C . For temperature in excess of 70 °C , The load shall be derated as shown below:

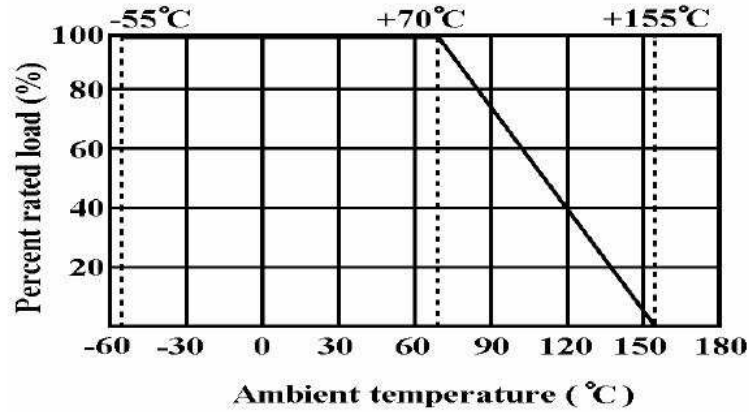

Voltage Rating

Resistors shall have a rated direct-current (DC) continuous working voltage or an approximate sine-wave root-mean-square (RMS) alternating-current (AC) continuous working voltage at commercial-line frequency and waveform corresponding to the power rating, as determined from the following formula:

$$RCWV = \sqrt{P \times R}$$

Where:

RCWV = Rated DC or RMS AC continuous working voltage at commercial-line frequency and waveform (volt)

P = Power Rating (watt)

R = Nominal Resistance (ohm)

In no case shall the rated DC or RMS AC continuous working voltage be greater than the applicable maximum value.

Construction:

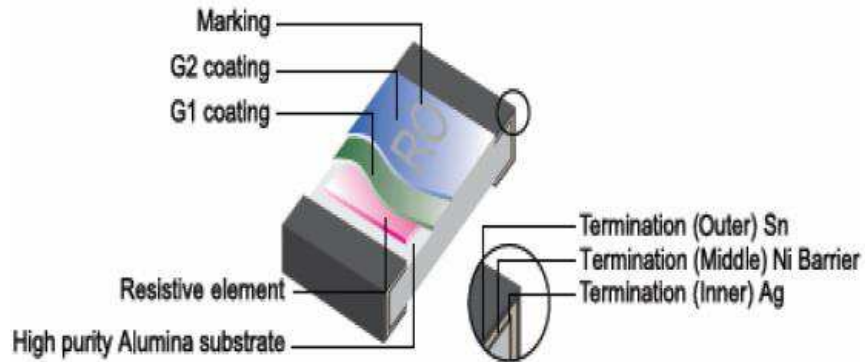

Dimensions:

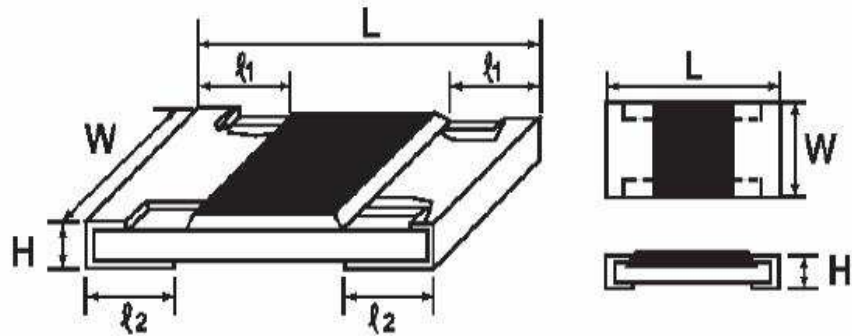

Type	Dimensions (mm)				
	L	W	H	ℓ1	ℓ2
CRGH0402	1.00 ±0.10	0.50 ±0.05	0.35 ±0.05	0.20 ±0.10	0.25 ±0.10
CRGH0603	1.60 ±0.10	0.80 ±0.10	0.45 ±0.10	0.30 ±0.20	0.30 ±0.20
CRGH0805	2.00 ±0.15	1.25 ^{+0.15} _{-0.10}	0.55 ±0.10	0.40 ±0.20	0.40 ±0.20
CRGH1206	3.10 ±0.15	1.55 ^{+0.15} _{-0.10}	0.55 ±0.10	0.45 ±0.20	0.45 ±0.20
CRGH1210	3.10 ±0.10	2.60 ±0.20	0.55 ±0.10	0.50 ±0.20	0.50 ±0.20
CRGH2010	5.00 ±0.10	2.50 ±0.20	0.55 ±0.10	0.60 ±0.25	0.50 ±0.20
CRGH2512	6.35 ±0.10	3.20 ±0.20	0.55 ±0.10	0.60 ±0.25	0.50 ±0.20

Performance Specification

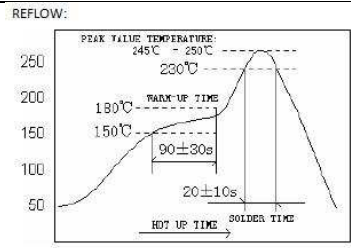
Characteristic	Limits	Test Methods (JIS C 5201-1)															
Dielectric Withstand Voltage	No evidence of flashover mechanical damage, arcing or insulation break down	4.7 Clamped in the trough of a 90°C metallic v-block and shall be tested at ac potential respectively specified in the type for 60-70 seconds															
Temperature Coefficient	$0.1\Omega \leq R \leq 0.976\Omega \pm 100$ (CRGH0603 = ± 200) $1\Omega \sim 10\Omega: \pm 200\text{PPM}/^\circ\text{C}$ $10.1\Omega \sim 10\text{M}\Omega: \pm 100\text{PPM}/^\circ\text{C}$ CRGH0402: $1\Omega \sim 10\Omega: \pm 400\text{PPM}/^\circ\text{C}$ $10.1\Omega \sim 100\Omega: \pm 200\text{PPM}/^\circ\text{C}$ $>100\Omega: \pm 100\text{PPM}/^\circ\text{C}$	4.8 Natural resistance change per temp. degree centigrade $R2 - R1$ $\text{-----} \times 10^6 \text{ (PPM}/^\circ\text{C)}$ $R1(t2-t1)$ R1: Resistance value at room temperature (T1) R2: Resistance value at room temp. plus 100 °C(T2) Test pattern: room temp. (T1), room temp. +100°C(T2)															
Short time overload	Resistance change rate is $\pm 5\%$ ($2.0\% + 0.1\Omega$) Max. $\pm 1\%$ ($1.0\% + 0.1\Omega$) Max.	4.13 Permanent resistance change after the application of a potential of 2.5 times RCWV for 5 seconds															
Solderability	95 % coverage Min.	Wave Solder: Test temperature of solder: $245^\circ\text{C} \pm 3^\circ\text{C}$ dipping time in solder : 2-3 seconds. 															
Soldering heat	Resistance change rate is: $\pm (1.0\% + 0.05\Omega)$ Max.	4.18 Dip the resistor into a solder bath having a temperature of $260^\circ\text{C} \pm 3^\circ\text{C}$ and hold it for 10 ± 1 seconds.															
Temperature cycling	Resistance change rate is $\pm 5\%$ ($1.0\% + 0.05\Omega$) Max. $\pm 1\%$ ($0.5\% + 0.05\Omega$) Max.	4.19 Resistance change after continuous 5 cycles for duty cycle specified below :															
		<table border="1"> <thead> <tr> <th>Step</th> <th>Temperature</th> <th>Time</th> </tr> </thead> <tbody> <tr> <td>1</td> <td>$-55^\circ\text{C} \pm 3^\circ\text{C}$</td> <td>30 mins</td> </tr> <tr> <td>2</td> <td>Room temp.</td> <td>10~15 mins</td> </tr> <tr> <td>3</td> <td>$+155^\circ\text{C} \pm 2^\circ\text{C}$</td> <td>30 mins</td> </tr> <tr> <td>4</td> <td>Room temp.</td> <td>10~15 mins</td> </tr> </tbody> </table>	Step	Temperature	Time	1	$-55^\circ\text{C} \pm 3^\circ\text{C}$	30 mins	2	Room temp.	10~15 mins	3	$+155^\circ\text{C} \pm 2^\circ\text{C}$	30 mins	4	Room temp.	10~15 mins
		Step	Temperature	Time													
		1	$-55^\circ\text{C} \pm 3^\circ\text{C}$	30 mins													
		2	Room temp.	10~15 mins													
3	$+155^\circ\text{C} \pm 2^\circ\text{C}$	30 mins															
4	Room temp.	10~15 mins															
Humidity	Resistance change rate is $\pm 5\%$ ($3.0\% + 0.1\Omega$) Max. $\pm 1\%$ ($0.5\% + 0.1\Omega$) Max.	4.24 Temporary resistance change after 240 hours exposure in a humidity test chamber controlled at $40 \pm 2^\circ\text{C}$ and 90-95% relative humidity															
Load life in humidity	Resistance change rate is $\pm 5\%$ ($3.0\% + 0.1\Omega$) Max. $\pm 1\%$ ($1.0\% + 0.1\Omega$) Max.	7.9 Resistance change after 1,000 hours (1.5 hours "on", 0.5 hour "off") at RCWV in a humidity chamber controlled at $40^\circ\text{C} \pm 2^\circ\text{C}$ and 90 to 95 % relative humidity															



Performance Specification (continued)

Characteristic	Limits	Test Methods (JIS C 5201-1)
Load Life	Resistance change rate is ± 5% (3.0% + 0.1Ω) Max. ± 1% (1.0% + 0.1Ω) Max.	4.25.1 Permanent resistance change after 1,000 hours operating at RCWV, with duty cycle of (1.5 hours"on", 0.5 hour"off") at 70°C ± 2°C ambient
Terminal bending	Resistance change rate is ± (1.0% + 0.05Ω) Max.	4.33 Twist of Test Board: Y/X = 3/90 mm for 60 seconds

Marking

E24 series 0603 – 2512 3 Digits – first two digits denote significant figures of resistance and third digit denotes number of zeros thereafter. EG

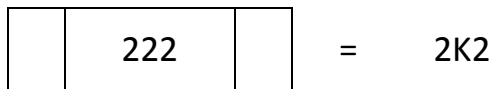

Marking for E96 Series 0805 – 2512 4 digits – First three digits denote significant figures of resistance and fourth digit denotes number of zeros thereafter. EG.

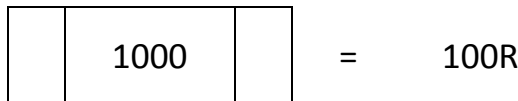

For ohmic values below 100R letter "R" denotes decimal point. EG

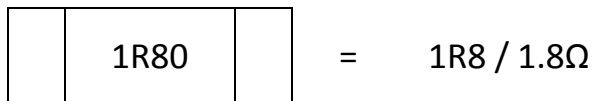

0402 size chips are not marked

0603 E96 3 digit marking.

Resistance Code from table on next page, and Multiplier code from table below

Multiplier Code

Code	A	B	C	D	E	F	G	H	X	Y	Z
Mult.	10 ⁰	10 ¹	10 ²	10 ³	10 ⁴	10 ⁵	10 ⁶	10 ⁷	10 ⁻¹	10 ⁻²	10 ⁻³

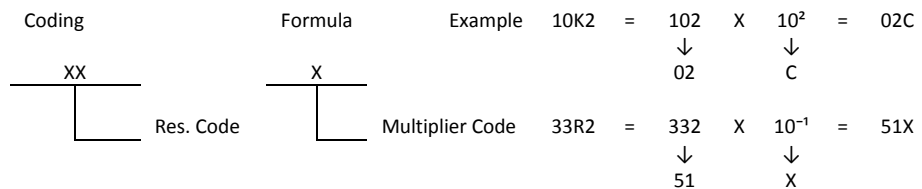

Resistance Code

Value	Code	Value	Code	Value	Code	Value	Code	Value	Code
100	01	162	21	261	41	422	61	681	81
102	02	165	22	267	42	432	62	698	82
105	03	169	23	274	43	442	63	715	83
107	04	174	24	280	44	453	64	732	84
110	05	178	25	287	45	464	65	750	85
113	06	182	26	294	46	475	66	768	86
115	07	187	27	301	47	487	67	787	87
118	08	191	28	309	48	499	68	806	88
121	09	196	29	316	49	511	69	825	89
124	10	200	30	324	50	523	70	845	90
127	11	205	31	332	51	536	71	866	91
130	12	210	32	340	52	549	72	887	92
133	13	215	33	348	53	562	73	909	93
137	14	221	34	357	54	576	74	931	94
140	15	226	35	365	55	590	75	953	95
143	16	232	36	374	56	604	76	976	96
147	17	237	37	383	57	619	77		
150	18	243	38	392	58	634	78		
154	19	249	39	402	59	649	79		
158	20	255	40	412	60	665	80		

Label

Label shall be marked with the following item :

- A. Nominal Resistance and Resistance Tolerance
- B. Power Rating and Size
- C. Quantity and description
- D. Part No.
- E. Lot No.
- Ex.



Packing Specification:

Tape dimensions (mm)

A. Paper Taping

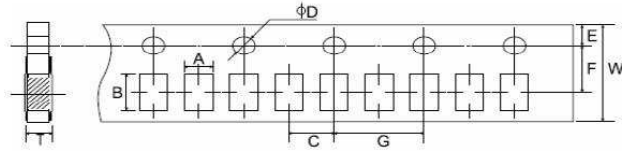

Type	A±0.2	B±0.2	C±0.05	ØD+0.1 -0	E±0.1	F±0.05	G±0.1	W±0.2	T±0.1
0402	0.65	1.15	2.0	1.5	1.75	3.5	4.0	8.0	0.45

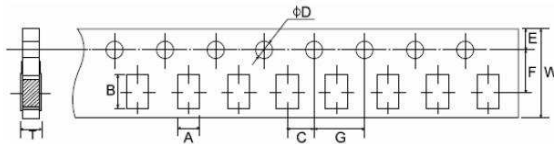

Type	A±0.2	B±0.2	C±0.05	ØD+0.1 -0	E±0.1	F±0.05	G±0.1	W±0.2	T±0.1
0603	1.10	1.90	2.0	1.5	1.75	3.5	4.0	8.0	0.67
0805	1.65	2.40	2.0	1.5	1.75	3.5	4.0	8.0	0.81
1206	2.00	3.60	2.0	1.5	1.75	3.5	4.0	8.0	0.81
1210	2.80	3.50	2.0	1.5	1.75	3.5	4.0	8.0	0.75

B. Embossed Taping

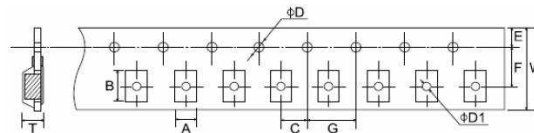

Type	A ±0.2	B ±0.2	C ±0.05	ØD+0.1 -0	ØD1+0.1 -0	E ±0.1	F ±0.05	G ±0.1	W ±0.2	T ±0.1
2010	2.90	5.60	2.0	1.5	1.5	1.75	5.5	4.0	12.0	1.0
2512	3.50	6.70	2.0	1.5	1.5	1.75	5.5	4.0	12.0	1.0

* Peeling Strength of Top Cover Tape

Test Condition: 0.1 to 0.7 N at a peel-off speed of 300 mm / min.

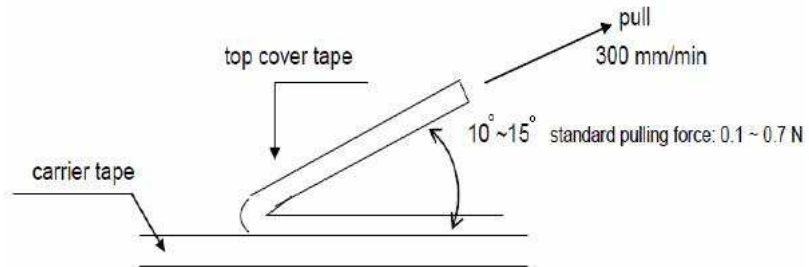

Reel Dimension (mm)

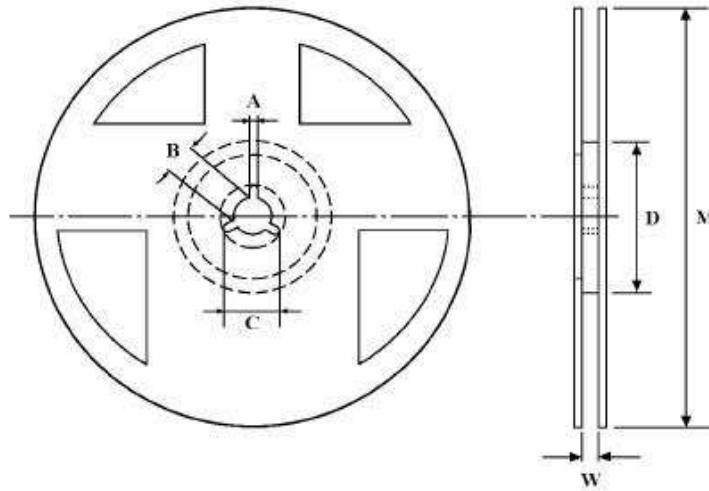

Type	Taping	Reel Quantity	A ±0.5	B ±0.5	C ±0.5	D ±1	M ±1	W ±1
0402	Paper	10,000	2	13	21	60	178	10
0603	Paper	5,000	2	13	21	60	178	10
0805	Paper	5,000	2	13	21	60	178	10
1206	Paper	5,000	2	13	21	60	178	10
1210	Paper	5,000	2	13	21	60	178	10
2010	Embossed	4,000	2	13	21	60	178	13.8
2512	Embossed	4,000	2	13	21	60	178	13.8

How To Order

CRGH	0603	J	10K
Common Part	Size	Tolerance	Resistance Value
CRGH - High Power Thick Film Chip Resistor	0402	F - ±1% J - ±5%	1 ohm (1Ω) 1R0
	0603		1K ohm (1000Ω) 1K0
	0805		100K ohm (100000Ω) 100K
	1206		
	1210		
	2010		
	2512		1M ohm (1000000Ω) 1M0

X-ON Electronics

Largest Supplier of Electrical and Electronic Components

Click to view similar products for [Thick Film Resistors - SMD category:](#)

Click to view products by [TE Connectivity manufacturer:](#)

Other Similar products are found below :

[CR-05FL7--19K6](#) [CR-05FL7--243R](#) [CR-05FL7--40K2](#) [CR-12JP4--680R](#) [CRCW06036K80FKEE](#) [M55342K06B2E94RS2](#)
[M55342K06B309DRS3](#) [M55342K06B6E81RS3](#) [M55342K08B100DRWB](#) [M55342M05B200DRWB](#) [M55342M06B26E7RS3](#) [MC0603-511-](#)
[JTW](#) [742C083750JTR](#) [MCR01MZPF1202](#) [MCR01MZPF1601](#) [MCR01MZPF1800](#) [MCR01MZPF6201](#) [MCR01MZPF9102](#) [MCR01MZPJ113](#)
[MCR01MZPJ121](#) [MCR01MZPJ125](#) [MCR01MZPJ203](#) [MCR01MZPJ751](#) [MCR01MZPJ822](#) [MCR03EZHJ103](#) [MCR03EZPFX1272](#)
[MCR03EZPJ123](#) [MCR03EZPJ270](#) [MCR03EZPJ821](#) [MCR10EZPF1102](#) [MCR10EZPF2003](#) [MCR10EZPF2700](#) [MCR18EZPJ330](#)
[RC0603F1473CS](#) [RC0603F150CS](#) [RC1005F1152CS](#) [RC1005F1182CS](#) [RC1005F1372CS](#) [RC1005F183CS](#) [RC1005F1911CS](#)
[RC1005F1912CS](#) [RC1005F203CS](#) [RC1005F2052CS](#) [RC1005F241CS](#) [RC1005F2431CS](#) [RC1005F3011CS](#) [RC1005F303CS](#)
[RC1005F4321CS](#) [RC1005F4642CS](#) [RC1005F471CS](#)