

Product Range

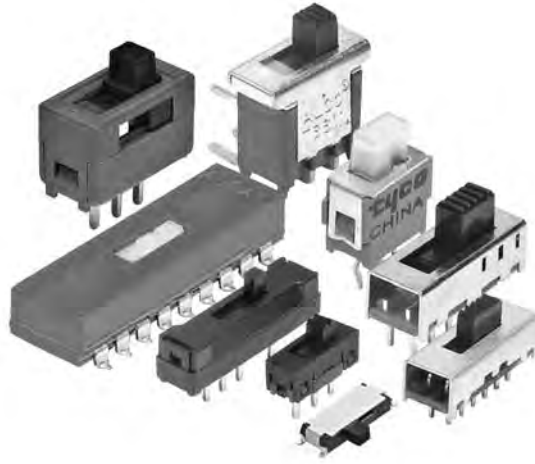

Slide Switches

■ **Telecom grade applications:**
AS Series

■ **Instrumentation grade applications:**
AS-, SSA-, SSB-, SSJ-, MSSA . 01/04-, MMS-, TSS-, MHS-,
MSS-, MSSA-, SDS-, STS-, CTS-, MLL-, A68 Series

■ **Consumer grade applications:**
S + SE-, SLS + SLSA-, STSA- Series

■ **Economy grade applications:**
SLS-Series

Main features:

- Up to 6 poles
- Up to 60.000 operations
- Silver or gold contacts, bifurcated double wipe contact versions
- Break-before-make or Make-before-break contact timing
- Sealed or unsealed, plastic or steel housings
- Micro sized versions
- Low profile versions
- Right angle versions
- Panel mount versions
- Different actuator styles
- Single or dual actuator
- SMT, THT, lug and turret terminals
- 2.54 mm or 5.08 mm terminal spacing
- Decorative versions



AS Series, Instrumentation and Telecom Grade, THT & SMTpage B2



S & SE Series, Sealed & Unsealed, THT & SMTpage B11



SSA Series, Micro Size, Instrumentation Grade, THTpage B14

Product Range (Continued)



SSB Series, Micro Size, Instrumentation Grade, THTpage B16



SSJ Series, Micro Size, Instrumentation Grade, THTpage B18



SLS Series, Miniature, Rolling Contact, Economy Grade, THTpage B20



SL Series, PC Tails, Consumer Grade, THTpage B23



SLS & SLSA Series, Panel Mount, Consumer, THTpage B25



SLS Series, PC Tails, Consumer Grade, THTpage B28



STS Series, Miniature, Low Profile, THTpage B30



STSA Series, Miniature, Low Profile, THTpage B34



MSSA .01/04 Series, Instrumentation Grade, THTpage B36

Product Range (Continued)



MMS Series, Micro Size, Instrumentation Grade, THTpage B40



TSS Series, Single or Dual Actuator, THTpage B43



MHS Series, Low Profile, Instrumentation Grade, THTpage B48



MSS Series, Instrumentation Grade, THTpage B52



MSSA Series, Instrumentation Grade, THTpage B58



SDS Series, Decorative Instrument Grade, THTpage B64



CST Series, Baton Toggle, THTpage B67



MLL Series, Micro Size, Low Profile, SMTpage B70



A68 Series, Instrumentation Grade, THTpage B72

AS Series, Instrumentation and Telecom Grade, THT & SMT

Slide Switches

Features

- Unique design enables aqueous or solvent cleaning
- Auto insertable
- ASF-package with flush actuator allows auto insertion on standard IC equipment. Standard tape seal and closed case construction provide process seal
- ASE-package with extended actuator, open ended case allows washout after process cleaning
- 2, 4 & 6 pole versions available with top or side actuation.
- Bifurcated double wipe contact design provide dependable, telecom grade switching
- Industry standard 2.54 (.100) x 7.62 (.300) terminal spacing

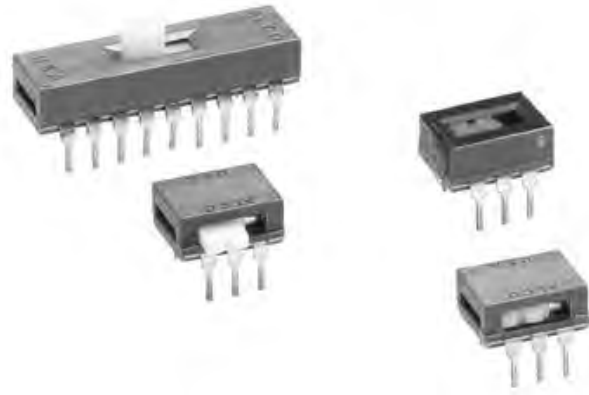

Typical performance characteristics

Contact rating, gold 0.4 VA @ 20 VDC or peak AC (shorting)
 Contact rating, silver 300 mA @ 115 VAC or 28 VDC
 Electrical life 15,000 cycles
 Mechanical life 15,000 cycles
 Contact resistance max 40 mOhm
 Insulation resistance min 1000 MOhm
 Dielectric strength 600 VAC for 1 min
 Actuation force 8.50 N (850 gf) max
 Actuator travel 2.54 mm (.100) average

Environmental specification

Operating temperature -40 to +80°C
 Storage temperature -40 to +80°C
 Solder heat resistance 265°C/10s wave or 260°C/10s reflow

Material specifications

Contacts copper alloy gold or silver finish
 Actuator nylon
 Terminals copper alloy tin finish
 Base pct
 Cover pct
 Tape polyimide
 RoHS Directive 2002/95/EC compliant

Product key	Typical product key		AS	E	2	2	G	S	04
Type	AS Slide switch, auto insertable								
Actuator	E extended	F flush							
No of poles	2 double pole	6 6 pole							
	4 4 pole								
No of throws	2 2 throws	3 3 throws (4 pole only)							
Actuation	blank top actuator	R side actuator							
Contact finish	blank silver	G gold							
Termination	blank through hole THT	L gullwing SMT							
		S J-lead SMT							
Packaging	blank tube	TR tape & reel							
Material	04 RoHS compliant								

AS Series, Instrumentation and Telecom Grade, THT & SMT (Continued)

E Extended actuator



Code	Type	Dim A
ASE22	DPDT	10.2mm (.400)
ASE42	4PDT	17.8mm (.700)
ASE43	4P3T	27.9mm (1.10)
ASE62	6PDT	25.4mm (1.00)

Upright, through hole



ASE62G

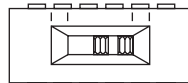

EXTENDED TOP ACTUATOR

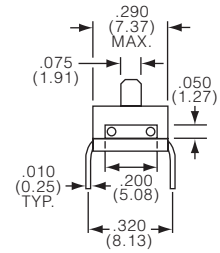
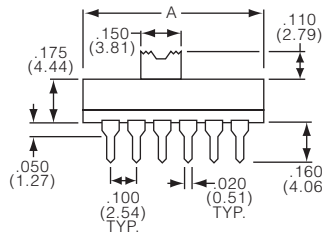

Right angle, through hole



ASE22R

EXTENDED SIDE ACTUATOR



.150 (3.81)

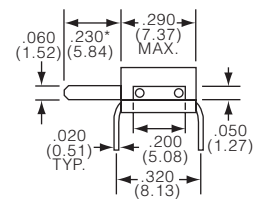
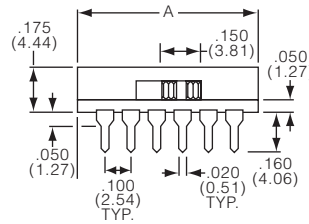

*.105 (2.67) ASE22R, ASE22RG

Upright, gullwing surface mount

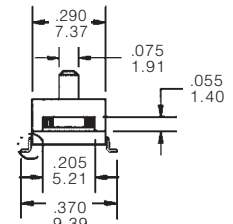
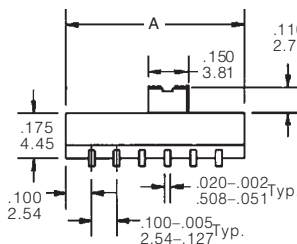
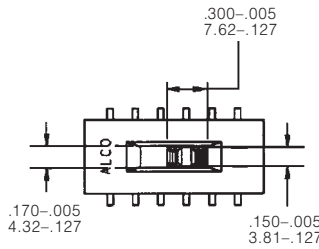

Right angle, gullwing surface mount



.150 (3.81)

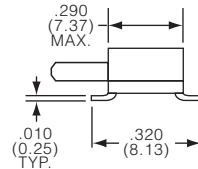
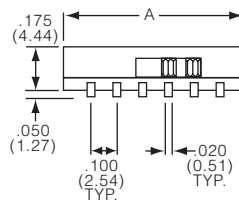

AS Series, Instrumentation and Telecom Grade, THT & SMT (Continued)

Slide Switches

Upright, J-lead surface mount

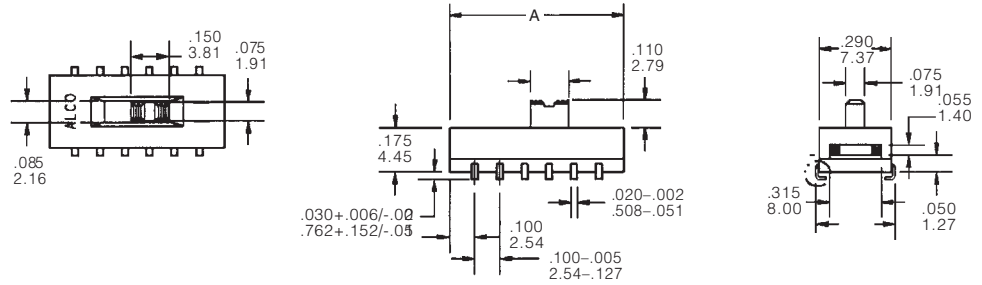

Right angle, J-lead surface mount

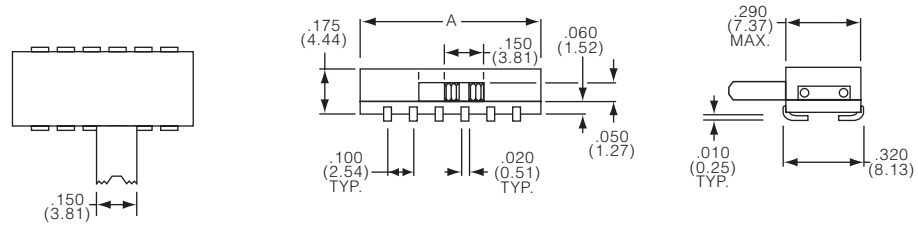

F Flush actuator



Code	Type	Dim A
ASF22	DPDT	10.2mm (.400)
ASF42	4PDT	17.8mm (.700)
ASF43	4P3T	27.9mm (1.10)
ASF62	6PDT	25.4mm (1.00)

Upright, through hole

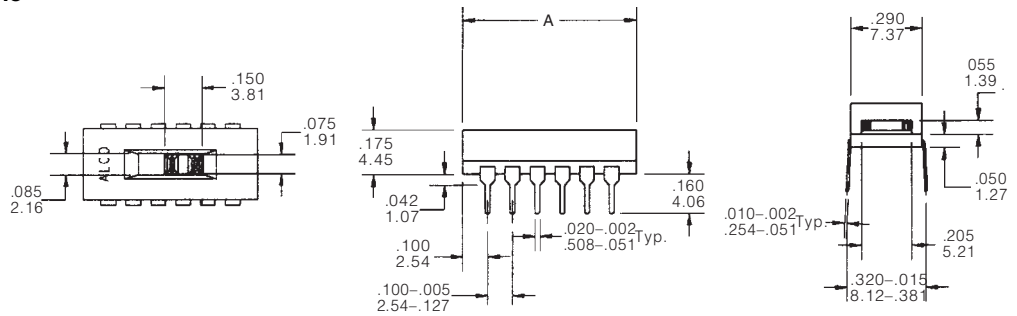

Right angle, through hole

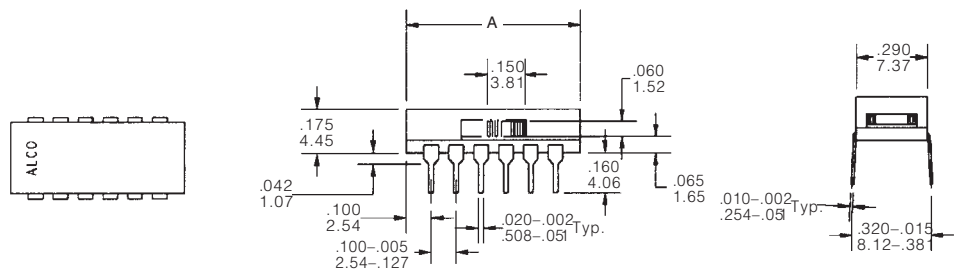

AS Series, Instrumentation and Telecom Grade, THT & SMT (Continued)

Upright, gullwing surface mount

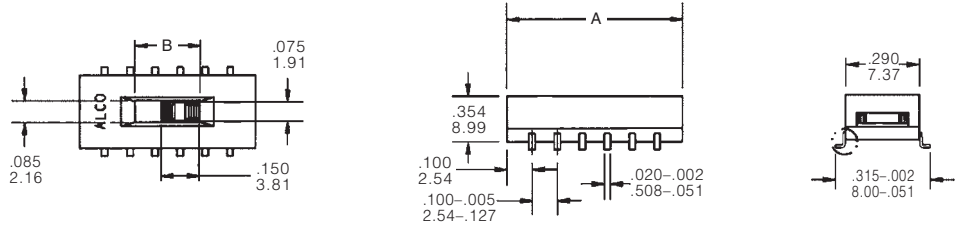

Right angle, gullwing surface mount

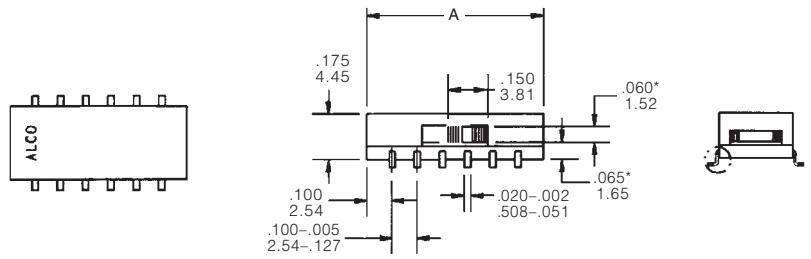

Upright, J-lead surface mount

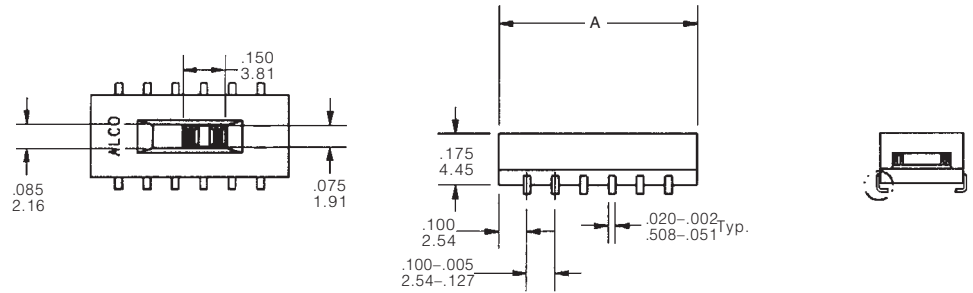

Right angle, J-lead surface mount

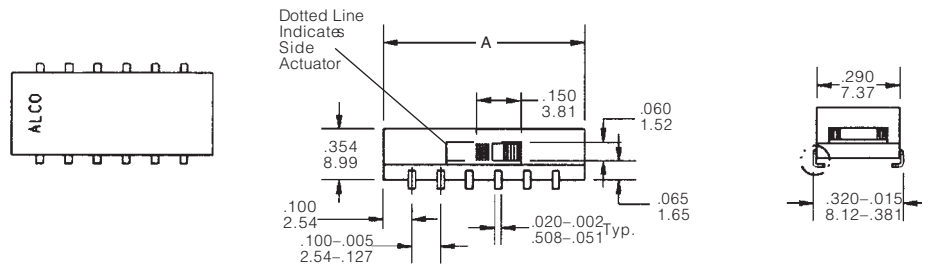

Circuit diagrams

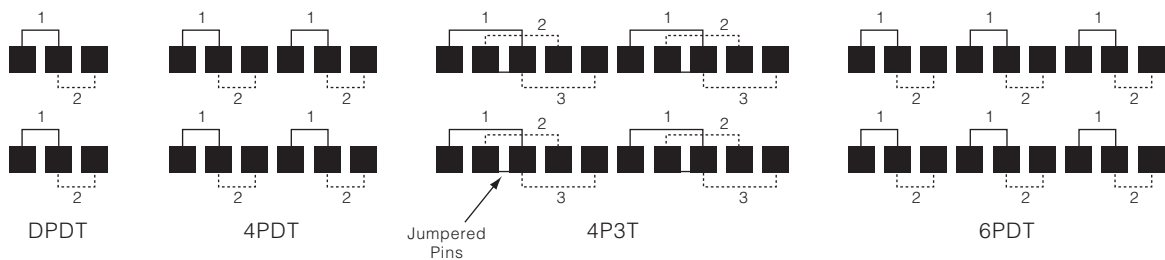

AS Series, Instrumentation and Telecom Grade, THT & SMT (Continued)

PCB layout

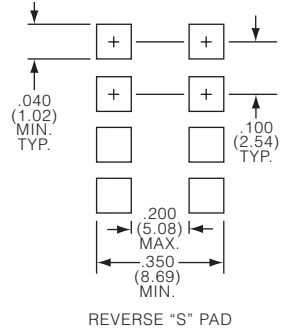
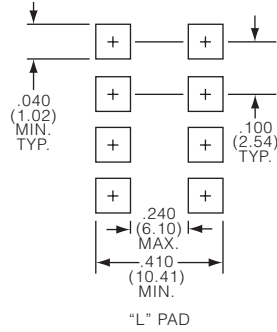
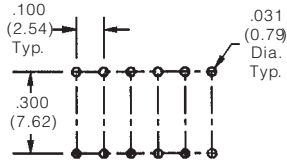

AS Series, Instrumentation and Telecom Grade, THT & SMT (Continued)

Product key	Actuator	Poles	Throws	Actuation	Contacts	Termination	Packaging	Material	Part Number
ASE2204	extended	double	2 throws	top	silver	THT	tube	RoHS	1825010-1
ASE22G04	actuator	pole		actuator	gold			compliant	1825010-2
ASE22GL04						gullwing			1825010-5
ASE22GS04						J-lead			1825010-7
ASE22L04					silver	gullwing			1825010-6
ASE22R04				side		THT			1825010-3
ASE22RG04				actuator	gold				1825010-4
ASE22RGL04						gullwing			1825010-9
ASE22RGS04						J-lead			1-1825010-1
ASE22RL04					silver	gullwing			1-1825010-0
ASE22RS04						J-lead			1-1825010-2
ASE22S04				top					1825010-8
ASE4204		4 pole		actuator		THT			1-1825010-3
ASE42G04					gold				1-1825010-4
ASE42GL04						gullwing			1-1825010-7
ASE42GS04						J-lead			1-1825010-9
ASE42L04					silver	gullwing			1-1825010-8
ASE42R04				side		THT			1-1825010-5
ASE42RG04				actuator	gold				1-1825010-6
ASE42RGL04						gullwing			2-1825010-1
ASE42RGS04						J-lead			2-1825010-3
ASE42RL04					silver	gullwing			2-1825010-2
ASE42RS04						J-lead			2-1825010-4
ASE42S04				top					2-1825010-0
ASE4304			3 throws	actuator		THT			2-1825010-5
ASE43G04					gold				2-1825010-6
ASE43GL04						gullwing			2-1825010-9
ASE43GS04						J-lead			3-1825010-1
ASE43L04					silver	gullwing			3-1825010-0
ASE43R04				side		THT			2-1825010-7
ASE43RG04				actuator	gold				2-1825010-8
ASE43RGL04						gullwing			3-1825010-3
ASE43RGS04						J-lead			3-1825010-5
ASE43RL04					silver	gullwing			3-1825010-4
ASE43RS04						J-lead			3-1825010-6
ASE43S04				top					3-1825010-2
ASE6204		6 pole	2 throws	actuator		THT			3-1825010-7
ASE62G04					gold				3-1825010-8
ASE62GL04						gullwing			4-1825010-1
ASE62GS04						J-lead			4-1825010-3
ASE62L04					silver	gullwing			4-1825010-2
ASE62R04				side		THT			3-1825010-9
ASE62RG04				actuator	gold				4-1825010-0
ASE62RGL04						gullwing			4-1825010-5
ASE62RGS04						J-lead			4-1825010-7
ASE62RL04					silver	gullwing			4-1825010-6
ASE62RS04						J-lead			4-1825010-8
ASE62S04				top a.					4-1825010-4

Preferred parts in bold print

Product key	Actuator	Poles	Throws	Actuation	Contacts	Termination	Packaging	Material	Part Number
ASF2204	flush	double	2 throws	top	silver	THT	tube	RoHS	1825011-1
ASF22G04	actuator	pole		actuator	gold			compliant	1825011-2
ASF22GL04						gullwing			1825011-5
ASF22GLTR04							tape & reel		1825011-6
ASF22GS04						J-lead	tube		1825011-9
ASF22GSTR04							tape & reel		1-1825011-0
ASF22L04					silver	gullwing	tube		1825011-7
ASF22LTR04							tape & reel		1825011-8
ASF22R04				side		THT	tube		1825011-3
ASF22RG04				actuator	gold				1825011-4
ASF22RGL04						gullwing			1-1825011-3
ASF22RGLTR04							tape & reel		1-1825011-4
ASF22RGS04						J-lead	tube		1-1825011-7
ASF22RGSTR04							tape & reel		1-1825011-8
ASF22RL04					silver	gullwing	tube		1-1825011-5
ASF22RLTR04							tape & reel		1-1825011-6
ASF22RS04						J-lead	tube		1-1825011-9
ASF22RSTR04							tape & reel		2-1825011-0
ASF22S04				top			tube		1-1825011-1
ASF22STR04				actuator			tape & reel		1-1825011-2

Preferred parts in bold print

AS Series, Instrumentation and Telecom Grade, THT & SMT (Continued)

Slide Switches

Product key	Actuator	Poles	Throws	Actuation	Contacts	Termination	Packaging	Material	Part Number
ASF4204	flush	4 pole	2 throws	top	silver	THT	tube	RoHS	2-1825011-1
ASF42G04	actuator			actuator	gold			compliant	2-1825011-2
ASF42GL04						gullwing			2-1825011-5
ASF42GLTR04							tape & reel		2-1825011-6
ASF42GS04						J-lead	tube		2-1825011-9
ASF42GSTR04							tape & reel		3-1825011-0
ASF42L04					silver	gullwing	tube		2-1825011-7
ASF42LTR04							tape & reel		2-1825011-8
ASF42R04				side		THT	tube		2-1825011-3
ASF42RG04				actuator	gold				2-1825011-4
ASF42RGL04						gullwing			3-1825011-3
ASF42RGLTR04							tape & reel		3-1825011-4
ASF42RGS04						J-lead	tube		3-1825011-7
ASF42RGSTR04							tape & reel		3-1825011-8
ASF42RL04					silver	gullwing	tube		3-1825011-5
ASF42RLTR04							tape & reel		3-1825011-6
ASF42RS04						J-lead	tube		3-1825011-9
ASF42RSTR04							tape & reel		4-1825011-0
ASF42S04				top			tube		3-1825011-1
ASF42STR04				actuator			tape & reel		3-1825011-2
ASF4304			3 throws			THT	tube		4-1825011-1
ASF43G04					gold				4-1825011-2
ASF43GL04						gullwing			4-1825011-5
ASF43GLTR04							tape & reel		4-1825011-6
ASF43GS04						J-lead	tube		4-1825011-9
ASF43GSTR04							tape & reel		5-1825011-0
ASF43L04					silver	gullwing	tube		4-1825011-7
ASF43LTR04							tape & reel		4-1825011-8
ASF43R04				side		THT	tube		4-1825011-3
ASF43RG04				actuator	gold				4-1825011-4
ASF43RGL04						gullwing			5-1825011-3
ASF43RGLTR04							tape & reel		5-1825011-4
ASF43RGS04						J-lead	tube		5-1825011-7
ASF43RGSTR04							tape & reel		5-1825011-8
ASF43RL04					silver	gullwing	tube		5-1825011-5
ASF43RLTR04							tape & reel		5-1825011-6
ASF43RS04						J-lead	tube		5-1825011-9
ASF43RSTR04							tape & reel		6-1825011-0
ASF43S04				top		THT	tube		5-1825011-1
ASF43STR04				actuator			tape & reel		5-1825011-2
ASF6204		6 pole	2 throws				tube		6-1825011-1
ASF62G04					gold				6-1825011-2
ASF62GL04						gullwing			6-1825011-5
ASF62GLTR04							tape & reel		6-1825011-6
ASF62GS04						J-lead	tube		6-1825011-9
ASF62GSTR04							tape & reel		7-1825011-0
ASF62L04					silver	gullwing	tube		6-1825011-7
ASF62LTR04							tape & reel		6-1825011-8
ASF62R04				side		THT	tube		6-1825011-3
ASF62RG04				actuator	gold				6-1825011-4
ASF62RGL04						gullwing			7-1825011-3
ASF62RGLTR04							tape & reel		7-1825011-4
ASF62RGS04						J-lead	tube		7-1825011-7
ASF62RGSTR04							tape & reel		7-1825011-8
ASF62RL04					silver	gullwing	tube		7-1825011-5
ASF62RLTR04							tape & reel		7-1825011-6
ASF62RS04						J-lead	tube		7-1825011-9
ASF62RSTR04							tape & reel		8-1825011-0
ASF62S04				top			tube		7-1825011-1
ASF62STR04				actuator			tape & reel		7-1825011-2

Preferred parts in bold print

S & SE Series, Sealed & Unsealed, THT & SMT

Features

- Sealed or unsealed
- Straight or right angle
- Through hole or surface mount
- Bulk or tape and reel packaged
- Compact size
- Double pole function in a single pole body
- PC retention feature
- High reliability contact system
- Epoxy sealed base
- Robust actuator for easy actuation
- Non shorting-break-before-make



Slide Switches

Typical performance characteristics

Contact rating, 0.4 VA @ 20 VDC or Peak AC (shorting)
 Contact rating, max 50 mA @ 48 VAC/DC
 Contact rating, min 1 microamp @ 20 millivolt AC/DC
 Electrical life. 10,000 cycles
 Mechanical life. 10,000 cycles
 Contact resistance, initial max 50 mOhm, 100 mOhm (after test)
 Insulation resistance min 500 MOhm
 Dielectric strength 500 VAC for 1 min
 Actuation force 0.70 to 50.0 N (70 to 500 gf)
 Actuator travel 2.20 mm (.087) average

Environmental specification

Operating temperature -20 to +80°C
 Storage temperature -40 to +80°C
 Solder heat resistance 265°C/10s wave or 260°C/10s reflow

Material specifications

Contacts copper alloy gold finish
 Actuator nylon
 Terminals copper alloy gold finish
 Base. nylon
 Frame. copper alloy tin finish
 Seal silicon rubber
 RoHS Directive 2002/95/EC compliant

Product key		Typical product key		S	E	1	DG	SMT	TR	04
Type	S	Slide switch, through hole and surface mount								
Seal	blank	unsealed	E	sealed						
No of poles	1	single pole	2	double pole						
No of throws	G	single throw	DG	double throw						
	EG	triple throw								
Terminal	PC	through hole THT, vertical	RA	through hole THT, right angle						
	SMT	surface mount SMT								
Packaging	blank	tray	TR	tape & reel						
Material	04	RoHS compliant								

S & SE Series, Sealed & Unsealed, THT & SMT (Continued)

Slide Switches

Terminal



PC through hole THT, vertical

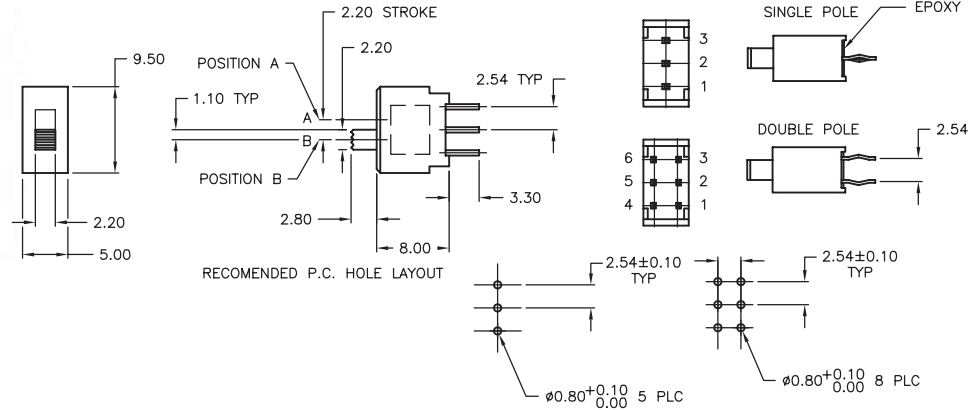

RA through hole THT, right angle

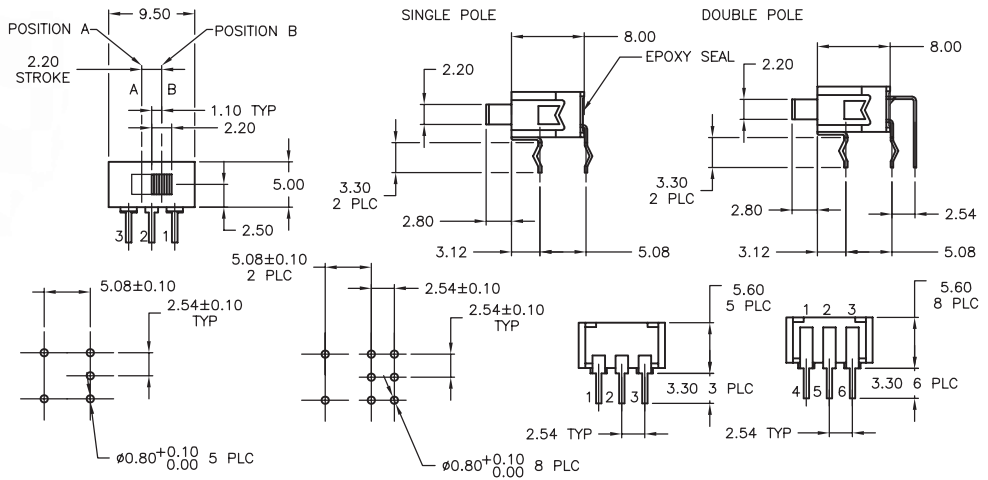

SMT surface mount, SMT

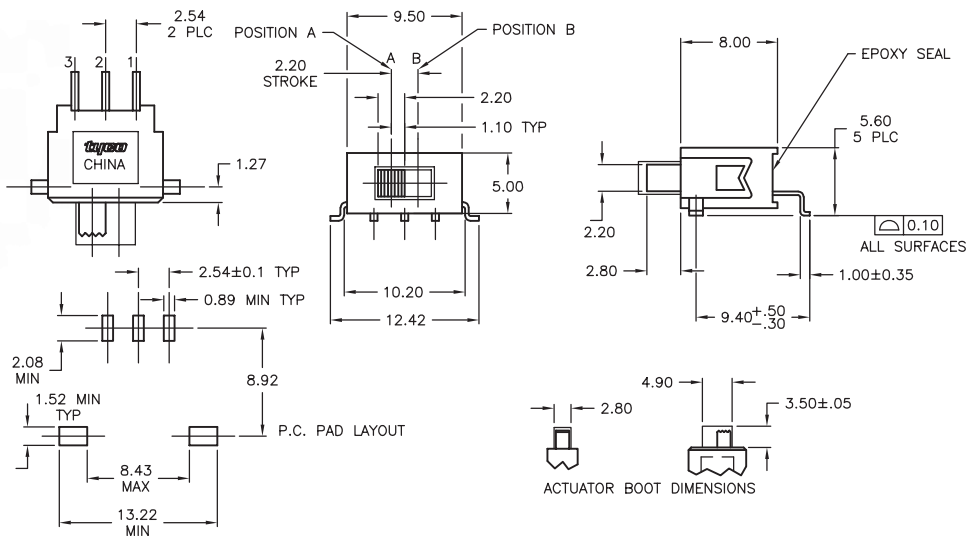

S & SE Series, Sealed & Unsealed, THT & SMT (Continued)

Function

Code	Poles	Throws	■	■	■
1G	single	single	Off	None	On 1 - 3
1DG		double	On 2 - 3	None	On 1 - 2
1EG		triple	On 2 - 3	Off	On 1 - 2
2DG	double	double	On 2 - 3 5 - 6	None	On 1 - 2 4 - 5
2EG		triple	On 2 - 3 5 - 6	Off	On 1 - 2 4 - 5

Off mechanical position, no electrical connection
 None no mechanical position

Product key	Seal	No of poles	No of throws	Terminal	Packaging	Material	Part Number			
S1DGPC04	unsealed	single pole	double throw	THT vertical	tray	RoHS compliant	5-1571005-1			
S1DGRA04				THT right angle			5-1571006-1			
S1EGPC04				triple throw			THT vertical	5-1571005-2		
S1EGRA04		sealed	double pole	double throw	THT right angle			5-1571006-2		
S2DGPC04					THT vertical			5-1571005-3		
S2DGRA04					THT right angle			5-1571006-3		
S2EGPC04	single pole		triple throw	triple throw	THT vertical			5-1571005-4		
S2EGRA04					THT right angle			5-1571006-4		
SE1DGPC04					THT vertical			1825032-1		
SE1DGRA04		THT right angle	1825031-1							
SE1DGSMT04		SMT	single pole	double throw	SMT	tray		5-1571004-3		
SE1DGSMTTR04					triple throw			triple throw	THT vertical	tape&reel
SE1EGPC04	THT right angle								tray	1825032-2
SE1EGRA04	THT right angle								tray	1825031-2
SE1EGSMT04	SMT								tray	5-1571004-2
SE1EGSMTTR04	tape&reel								tray	5-1571004-5
SE1GSMT04	tray		tray	5-1571004-1						
SE1GSMTTR04	tape&reel		tray	5-1571004-4						
SE2DGPC04	double pole		double throw	double throw	THT vertical	tray		1825032-3		
SE2DGRA04					THT right angle			1825031-3		
SE2EGPC04					triple throw			THT vertical	1825032-4	
SE2EGRA04			triple throw	triple throw	triple throw	THT right angle			1825031-4	

Preferred parts in bold print

SSA Series, Micro Size, Instrumentation Grade, THT

Features

- Break-Before-Make timing



Slide Switches

Typical performance characteristics

Contact rating gold-0.4 VA @ 20 VDC
 silver-100 milliamps @ 30 VDC
 Electrical life 10.000 cycles
 Mechanical life 10.000 cycles
 Contact resistance, initial max 30 mOhm, 100 mOhm (after test)
 Insulation resistance min 100 MOhm
 Dielectric strength 500 VAC for 1 min
 Actuation force 2.5 N (250 gf) average
 Actuator travel 2.50 mm (.098) average

Environmental specification

Operating temperature -20 to +85°C
 Storage temperature -40 to +100°C
 Solder heat resistance 265°C/10s wave

Material specifications

Contacts copper alloy silver or gold finish
 Actuator nylon
 Terminals copper alloy silver or gold finish
 Base pps
 Cover nylon
 RoHS Directive 2002/95/EC compliant

Product key		Typical product key		SSA	1	2	04
Type	SSA Slide switch, micro size, instrumentation grade						
No of poles	1 single pole	2	double pole				
No of throws	2 2 throws						
Plating	blank silver	G	gold				
Material	04 RoHS compliant						

SSA Series, Micro Size, Instrumentation Grade, THT (Continued)

Number of poles



single pole



SSA12

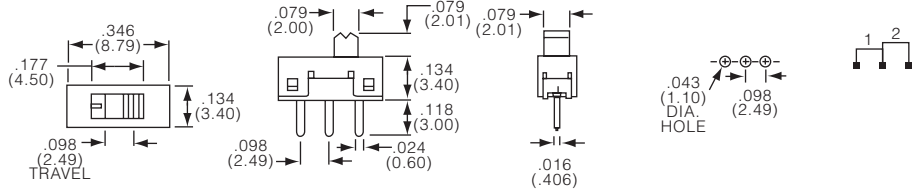

double pole



SSA22

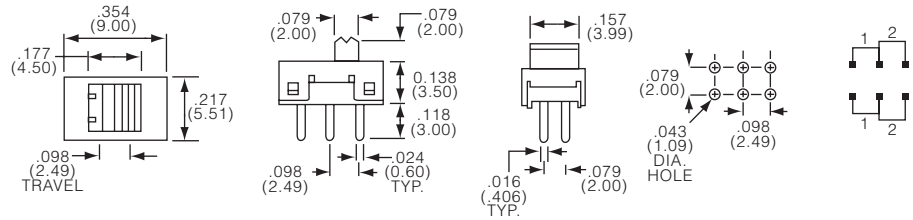

Product key	No of poles	No of throws	Plating	Material	Part Number
SSA1204	single	2 throws	silver	RoHS	1571981-1
SSA12G04	pole		gold	compliant	1571981-2
SSA2204	double		silver		1571981-3
SSA22G04	pole		gold		1571981-4

Preferred parts in bold print

SSB Series, Micro Size, Instrumentation Grade, THT

Slide Switches

Features

- Upright or right angle
- Make-before-Break timing



Typical performance characteristics

Contact rating gold-0.4 VA @ 20 VDC
 silver-100 milliamps @ 30 VDC
 Electrical life 10,000 cycles
 Mechanical life 10,000 cycles
 Contact resistance, initial max 30 mOhm, 100 mOhm (after test)
 Insulation resistance min 100 MOhm
 Dielectric strength 500 VAC for 1 min
 Actuation force 2.5 N (250 gf) average
 Actuator travel 2.00 mm (.079) average

Environmental specification

Operating temperature -10 to +85°C
 Storage temperature -40 to +100°C
 Solder heat resistance 265°C/10s wave

Material specifications

Contacts copper alloy silver or gold finish
 Actuator pom
 Terminals copper alloy silver or gold finish
 Base phenolic
 Cover nylon
 Frame steel tin finish
 RoHS Directive 2002/95/EC compliant

Product key		Typical product key				
		SSB	1	2	R	G
Type	SSB Slide switch, micro size, instrumentation grade					
No of poles						
1	single pole		4			
2	double pole					
No of throws						
2	2 throws					
Actuation						
blank	vertical				R	
Plating						
blank	silver					G

Single pole
 double throw, vertical

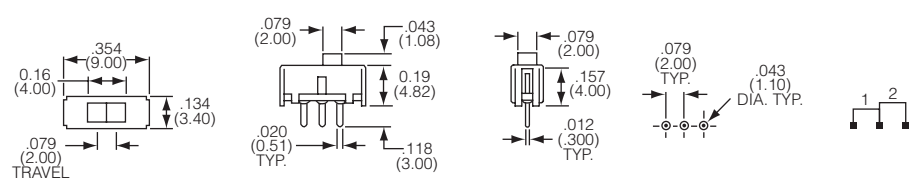

SSB Series, Micro Size, Instrumentation Grade, THT (Continued)

double throw, right angle

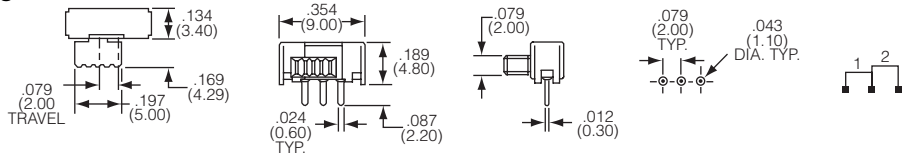

Double pole



double throw, vertical

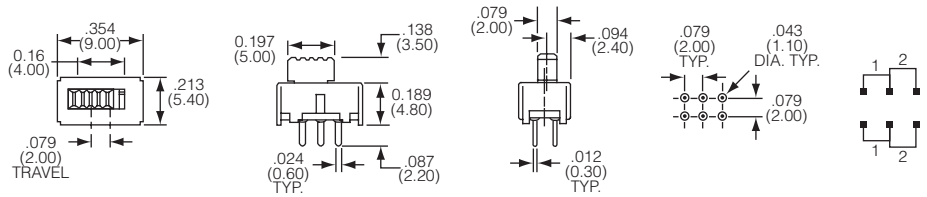

double throw, right angle

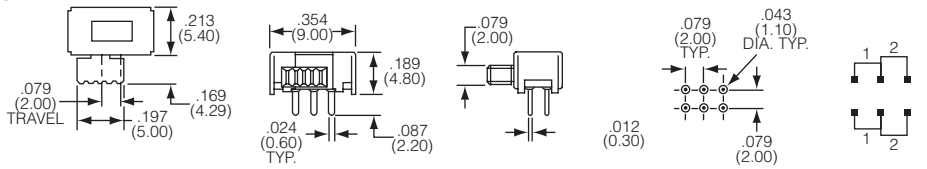

4 pole



double throw, vertical

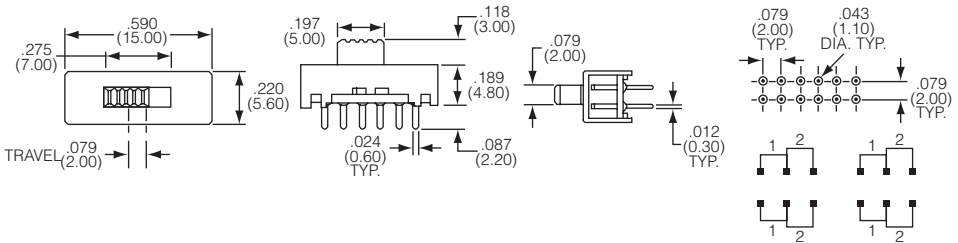

Product key	No of poles	No of throws	Actuation	Plating	Part Number
SSB12	single pole	2 throws	vertical	silver	1-1437575-8
SSB12G				gold	1-1437575-9
SSB12R			right angle	silver	2-1437575-0
SSB12RG				gold	2-1437575-1
SSB22	double pole		vertical	silver	2-1437575-2
SSB22G				gold	2-1437575-3
SSB22R			right angle	silver	2-1437575-4
SSB22RG				gold	2-1437575-5
SSB42	4 pole		vertical	silver	2-1437575-8
SSB42G				gold	2-1437575-9

SSJ Series, Micro Size, Instrumentation Grade, THT (Continued)

Single pole



double throw, vertical



SSJ12

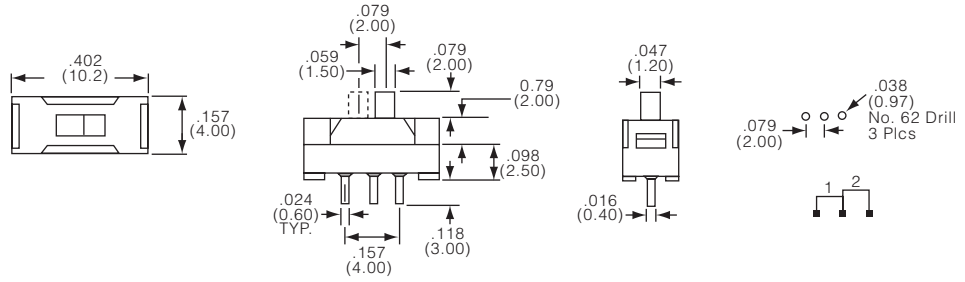

double throw, right angle



SSJ12R

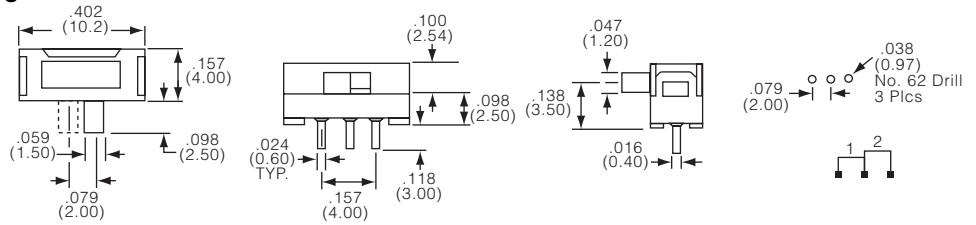

triple throw, vertical



SSJ13

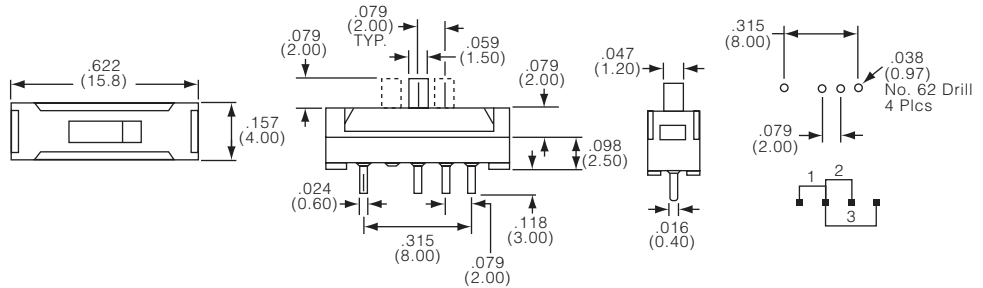

Product key	No of poles	No of throws	Actuation	Material	Part Number
SSJ1204	single pole	2 throws	vertical	RoHS	1825280-1
SSJ12R04	single pole	2 throws	right-angle	compliant	1825282-1
SSJ1304	single pole	3 throws	vertical	compliant	1825283-1

Preferred parts in bold print

SLS Series, Miniature, Rolling Contact, Economy Grade, THT

Slide Switches

Features

- High reliability contact system
- Robust actuator for easy actuation
- Break-before-Make timing

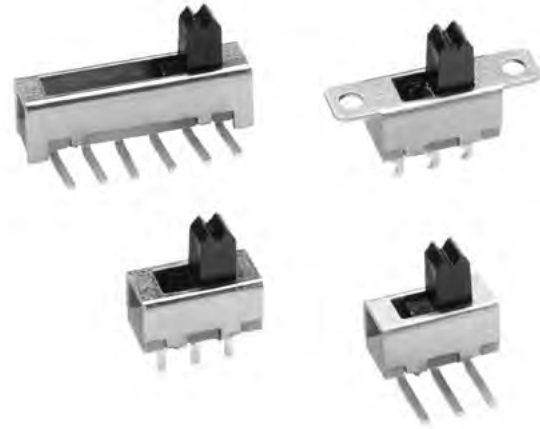

Typical performance characteristics

Contact rating 250 milliamps @ 125 VAC, 150 milliamps @ 12 VDC
 Electrical life no load 10,000 cycles
 no load, at rated current, 8,000 cycles
 Mechanical life 10,000 cycles
 Contact resistance, initial max 30 mOhm, 60 mOhm (after test)
 Insulation resistance min 500 MOhm
 Dielectric strength 500 VAC for 1 min
 Actuation force 2.5 +1.5/-1.0 N (250 +150/-100 gf)
 Actuator travel 3.20 mm (.126)

Environmental specification

Operating temperature -10 to +85°C
 Storage temperature -10 to +100°C
 Solder heat resistance 265°C/10s wave

Material specifications

Contacts copper alloy gold or silver finish
 Actuator pbt
 Terminals copper alloy gold or silver finish
 Frame steel zinc finish
 Terminal board phenolic
 RoHS Directive 2002/95/EC compliant

Product key	Typical product key		SLS	1	2	1	PC	04
Type	SLS Slide switch, PC tails, wiping contact, consumer grade							
No of poles	1 single pole							
No of throws	2 2 throws		4 4 throws					
	3 3 throws		5 5 throws					
Version	1 standard							
Actuator color	blank black		N natural					
Mounting	blank panel		RA right angle					
	PC printed circuit		1 printed circuit with lug					
Contacts	blank silver		G gold					
Material	04 RoHS compliant							

SLS Series, Miniature, Rolling Contact, Economy Grade, THT (Continued)

Double throw



panel mounting



SLS121

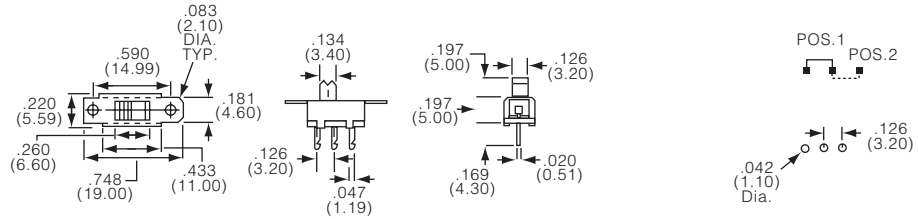

printed circuit mounting



SLS121PC

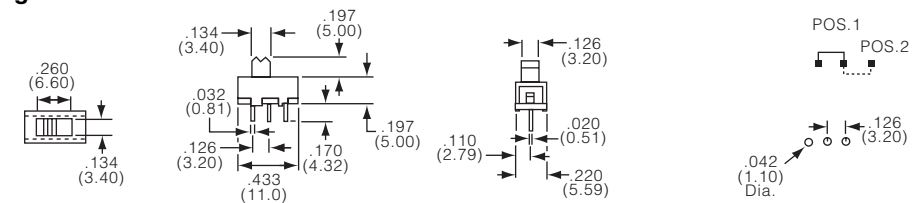

printed circuit, right angle mounting



SLS121RA

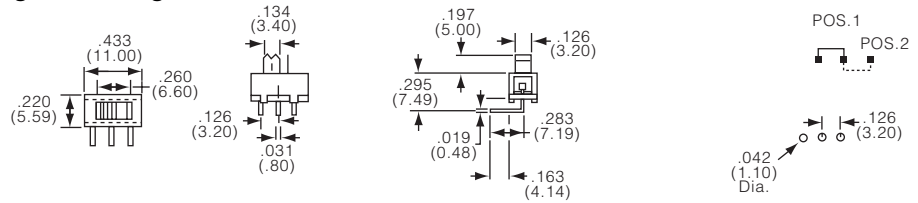

printed circuit with lug



SLS1211

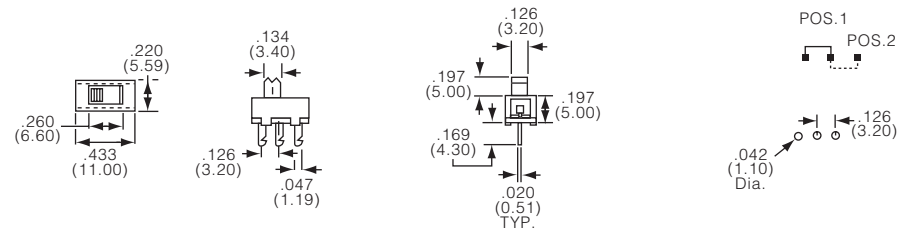

Triple throw



printed circuit mounting



SLS1311PC

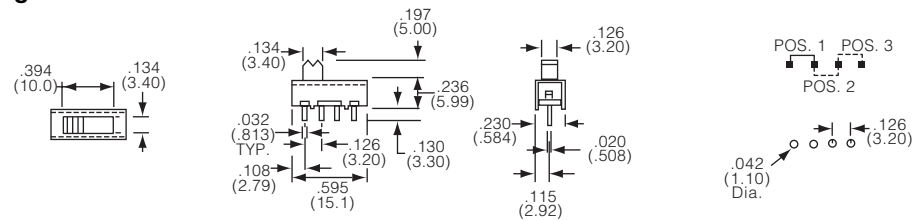

printed circuit, right angle mounting



SLS1311RA

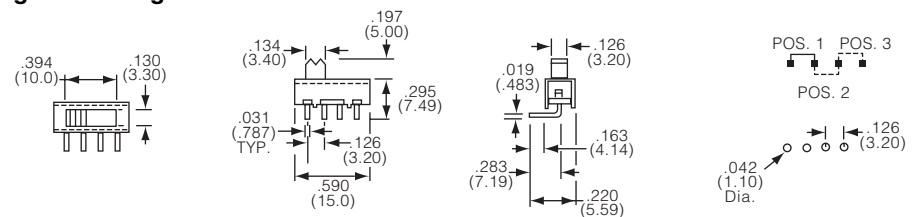

SLS Series, Miniature, Rolling Contact, Economy Grade, THT (Continued)

Slide Switches

4 throws



printed circuit mounting



SLS141PC

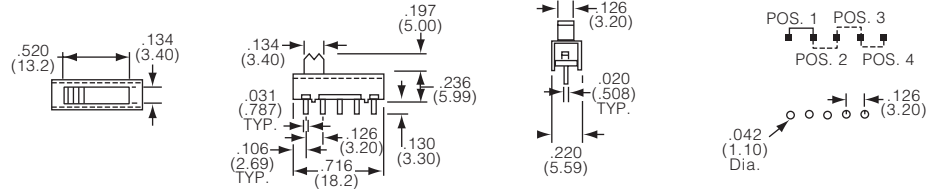

printed circuit, right angle mounting



SLS141RA

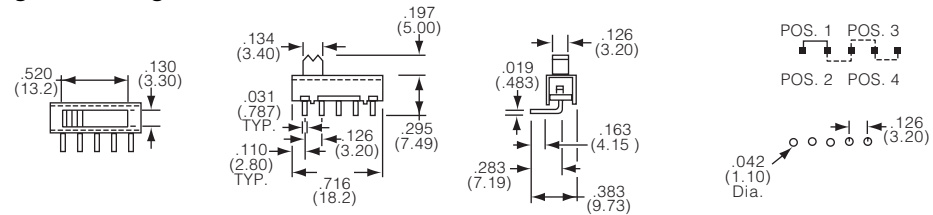

5 throws



printed circuit mounting



SLS151PC

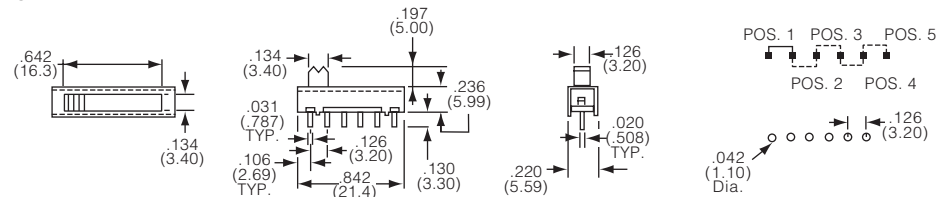

printed circuit, right angle mounting



SLS151RA

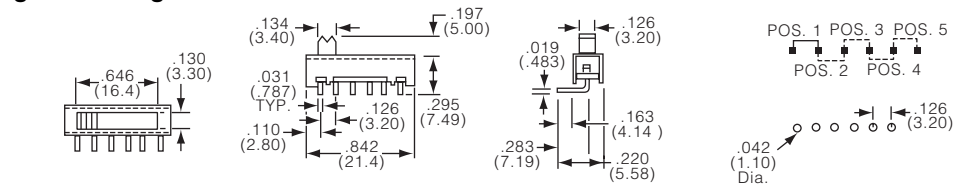

Product key	No of poles	No of throws	Mounting	Material	Part Number
SLS12104	single pole	2 throws	panel	RoHS compliant	1825076-1
SLS121104			pc with lug		1825077-1
SLS121NPC04	single pole	4 throws	printed circuit	RoHS compliant	1825115-3
SLS121NRA04			right angle		1825116-2
SLS121PC04			printed circuit		1825115-1
SLS121PCG04			right angle		1825115-2
SLS121RA04	single pole	4 throws	right angle	RoHS compliant	1825116-1
SLS131PC04			printed circuit		1825117-1
SLS131RA04	single pole	3 throws	right angle	RoHS compliant	1825118-1
SLS141PC04			printed circuit		1825119-1
SLS141RA04	single pole	4 throws	right angle	RoHS compliant	1825120-1
SLS151PC04			printed circuit		1825121-1
SLS151RA04	single pole	5 throws	right angle	RoHS compliant	1825122-1

Preferred parts in bold print

SL Series, PC Tails, Consumer Grade, THT

Features

- High reliability contact system
- Robust actuator for easy actuation
- Lever or knob actuator
- Break-before-Make timing
- Wiping contact



Slide Switches

Typical performance characteristics

Contact rating 250 milliamps @ 125 VAC, 150 milliamps @ 12 VDC
 Electrical life 10.000 cycles
 Mechanical life 10.000 cycles
 Contact resistance, initial max 30 mOhm, 60 mOhm (after test)
 Insulation resistance min 500 MOhm
 Dielectric strength 500 VAC for 1 min
 Actuation force 1.0 to 3.0 N (100 to 300gf)
 Actuator travel 4.0 mm (.157) average

Environmental specification

Operating temperature -10 to +60°C
 Storage temperature -10 to +60°C
 Solder heat resistance 265°C/10s wave

Material specifications

Contacts copper alloy silver finish
 Slider polycarbonate
 Actuator steel zinc finish
 Terminals copper alloy silver finish
 Frame steel tin finish
 Terminal board phenolic
 RoHS Directive 2002/95/EC compliant

Product key

Typical product key

SL 3 30 04

Type

SL Slide switch, PC tails, wiping contact, consumer grade

No of poles

2	2 poles	7	7 poles
3	3 poles	8	8 poles
5	5 poles	10	10 poles
6	6 poles		

No of positions

20	2 positions	70	7 positions
30	3 positions	80	8 positions
50	5 positions	00	10 positions
60	6 positions		

Material

04 RoHS compliant

SL Series, PC Tails, Consumer Grade, THT (Continued)

Slide Switches

Number of poles



Codes 2, 3, 5, 6, 7, 8, 10 2 to 10 poles



SL550



SL660 with KSS knob



SL770

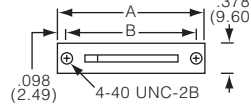
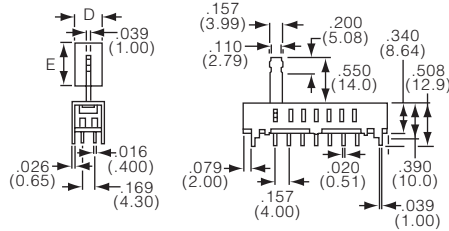

CONTACT ARRANGEMENT

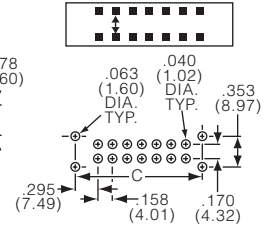

Pos.	Dim A	Dim B	Dim C	Knob	Dim D	Dim E
2	24.13 (.950)	19.05 (.750)	19.05 (.750)	KSS10A	6.86 (.270)	12.7 (.500)
3	28.19 (1.11)	23.1 (.910)	23.1 (.910)	KSS10B	6.86 (.270)	12.7 (.500)
5	36.07 (1.42)	30.99 (1.22)	31.1 (1.22)	KSS20A	7.75 (.305)	13.0 (.512)
6	40.13 (1.58)	35.05 (1.38)	35.1 (1.38)	KSS20B	7.75 (.305)	13.0 (.512)
7	44.20 (1.74)	39.12 (1.54)	39.1 (1.54)			
8	48.01 (1.89)	43.18 (1.70)	43.1 (1.70)			
10	56.13 (2.21)	51.05 (2.01)	51.1 (2.01)			

Product key	No of poles	No of positions	Material	Part Number
SL22004	2 pole	2 positions	RoHS compliant	1825073-1
SL33004	3 pole	3 positions		1825073-2
SL55004	5 pole	5 positions		1825073-3
SL66004	6 pole	6 positions		1825073-4
SL77004	7 pole	7 positions		1825073-5
SL88004	8 pole	8 positions		1825073-6
SL100004	10 pole	10 positions		1825073-7

SLS & SLSA Series, Panel Mount, Consumer Grade, THT

Features

- High reliability contact system
- Robust actuator for easy actuation
- Break-before-Make timing
- Wiping contact



Slide Switches

Typical performance characteristics

Contact rating 500 milliamps @ 125 VAC, 200 milliamps @ 12 VDC
 Electrical life 10.000 cycles
 Mechanical life 10.000 cycles
 Contact resistance, initial max 30 mOhm, 60 mOhm (after test)
 Insulation resistance min 500 MOhm
 Dielectric strength 500 VAC for 1 min
 Actuation force 3.5 +/-2.0 N (350 +/-200 gf)
 Actuator travel 2.69 mm (.106)

Environmental specification

Operating temperature -20 to +85°C
 Storage temperature -40 to +100°C
 Solder heat resistance 265°C/10s wave

Material specifications

Contacts copper alloy silver finish
 Actuator pbt
 Terminals copper alloy silver finish
 Frame steel zinc finish
 Terminal board phenolic
 RoHS Directive 2002/95/EC compliant

Product key	Typical product key		SLS	2	20	04
Type	SLS Slide switch, panel mount, wiping contact, consumer grade					
Terminal	blank lug	A turret				
No of poles	1 single pole	2 double pole				
No of throws	20 2 throws					
Frame style	blank panel mounting	1 no panel hole				
Material	04 RoHS compliant					

SLS & SLSA Series, Panel Mount, Consumer Grade, THT (Continued)

Slide Switches

Single Pole



lug terminal, panel mounting



SLS120

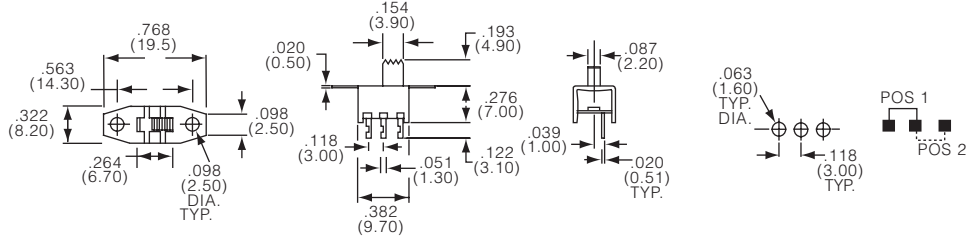

turret terminal, panel mounting



SLSA120

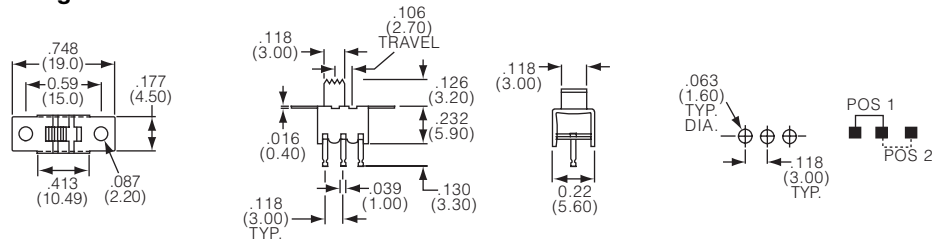

lug terminal, no panel hole



SLS1201

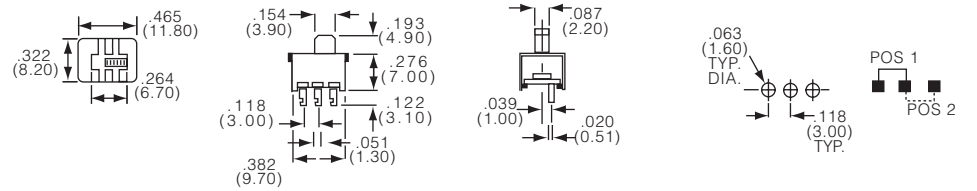

turret terminal, no panel hole



SLS2201

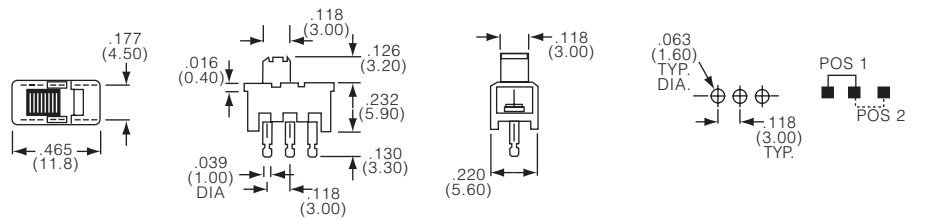

Double Pole



lug terminal, panel mounting



SLS220

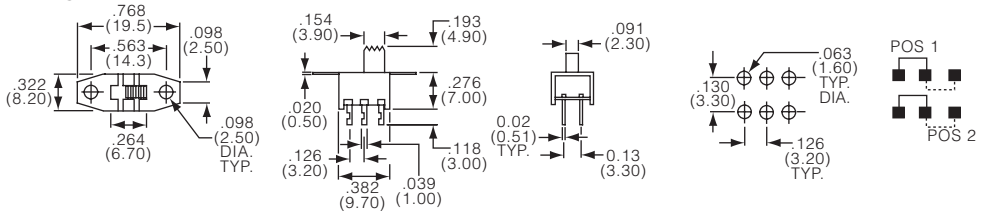

turret terminal, panel mounting

SLS & SLSA Series, Panel Mount, Consumer Grade, THT (Continued)



SLSA220

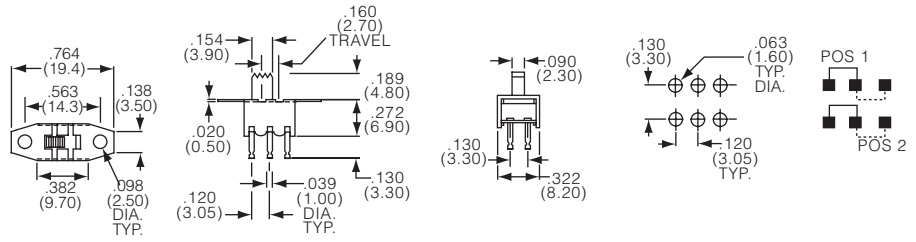

lug terminal, no panel hole



SLSA1201

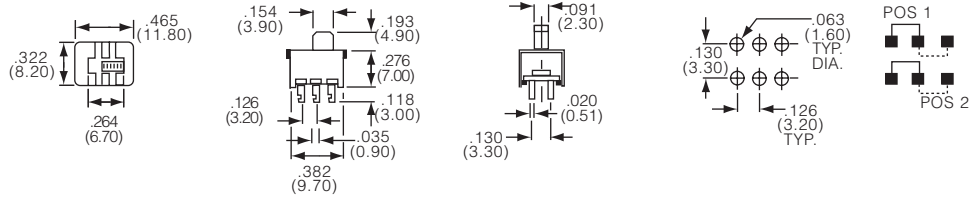

turret terminal, no panel hole



SLSA2201

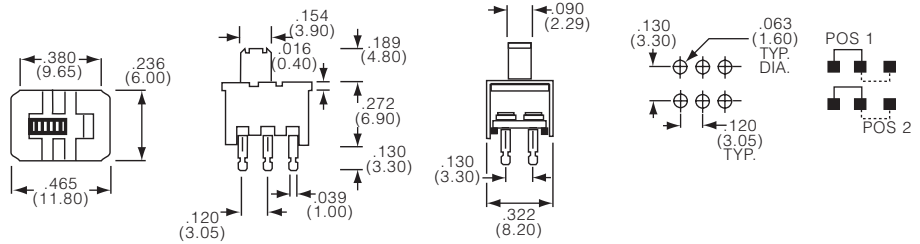

Product key	Terminal	No of poles	No of throws	Frame style	Material	Part Number
SLS12004	lug	single	2 throws	panel mount	RoHS compliant	1825074-1
SLS120104		pole		no panel hole		1825075-1
SLS22004		double		panel mount		1825078-1
SLS220104	turret	pole		no panel hole		1825079-1
SLSA12004		single		panel mount		1825081-1
SLSA120104		pole		no panel hole		1825082-1
SLSA22004		double		panel mount		1825083-1
SLSA220104		pole		no panel hole		1825087-1

SLS Series, PC Tails, Consumer Grade, THT

Slide Switches

Features

- High reliability contact system
- Robust actuator for easy actuation
- Break-before-Make timing
- Wiping contact



Typical performance characteristics

Contact rating 250 milliamps @ 125 VAC, 150 milliamps @ 12 VDC
 Electrical life 10.000 cycles
 Mechanical life 10.000 cycles
 Contact resistance, initial max 30 mOhm, 60 mOhm (after test)
 Insulation resistance min 500 MOhm
 Dielectric strength 500 VAC for 1 min
 Actuation force 2.50 N (250 gf) average
 Actuator travel 3.20 mm (.126) average

Environmental specification

Operating temperature -10 to +60°C
 Storage temperature -10 to +60°C
 Solder heat resistance 265°C/10s wave

Material specifications

Contacts copper alloy silver finish
 Actuator pbt
 Terminals copper alloy silver finish
 Case steel zinc finish
 Terminal board phenolic
 RoHS Directive 2002/95/EC compliant

Product key	Typical product key					SLS	2	40	PC	04
Type	SLS Slide switch, PC tails, wiping contact, consumer grade									
No of poles	2 2 poles									
No of positions	20 2 positions		50 5 positions							
	30 3 positions		60 6 positions							
	40 4 positions									
Mounting	PC printed circuit									
Material	04 RoHS compliant									

SLS Series, PC Tails, Consumer Grade, THT (Continued)

Number of positions



codes 20, 30, 40, 50, 60 2 to 6 positions



SLS220PC

SLS250PC

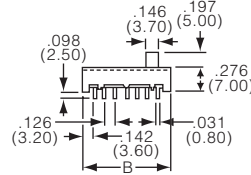
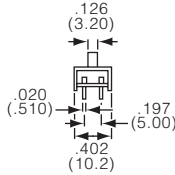
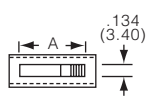

Pos.	Dim A	Dim B
2	6.91 (.272)	13.59 (.535)
3	10.11 (.398)	16.79 (.661)
4	13.31 (.524)	19.99 (.787)
5	16.51 (.650)	23.19 (.913)
6	19.71 (.776)	26.39 (1.04)



SLS240PC

SLS230PC

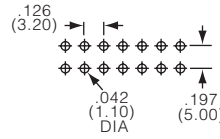
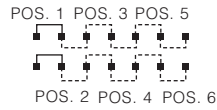

Product key	No of poles	No of positions	Mounting	Material	Part Number
SLS220PC04	double	2 positions	printed circuit	RoHS	1825080-1
SLS230PC04	pole	3 positions		compliant	1825080-2
SLS240PC04		4 positions			1825080-3
SLS250PC04		5 positions			1825080-4
SLS260PC04		6 positions			1825080-5

Preferred parts in bold print

STS Series, Miniature, Low Profile, THT

Features

- Upright or right angle
- High reliability contact system
- Robust actuator for easy actuation
- Make-before-Break timing



Slide Switches

Typical performance characteristics

Contact rating..... 250 milliamps @125 VAC
 Electrical life..... 10.000 cycles
 Mechanical life..... 10.000 cycles
 Contact resistance, initial max 30 mOhm, 60 mOhm (after test)
 Insulation resistance min 500 MOhm
 Dielectric strength..... 500 VAC for 1 min
 Actuation force..... 2.50 N (250 gf) average
 Actuator travel 2.49 (.098) average

Environmental specification

Operating temperature -10 to +60°C
 Storage temperature -10 to +60°C
 Solder heat resistance..... 265°C/10s wave

Material specifications

Contacts copper alloy silver finish
 Actuator..... pom
 Terminals..... copper alloy silver finish
 Case steel zinc finish
 Terminal board phenolic
 RoHS Directive 2002/95/EC compliant

Product key	Typical product key		STS	1	2	1	RA	04
Type	Miniature, low profile slide switch							
No of poles	1 single pole	2 double pole						
No of throws	2 two throws	5 five throws						
	3 three throws	6 six throws						
	4 four throws							
Pinning	in-line spacing without break							
	dual row in-line spacing without break							
	in-line spacing with break							
Actuation	vertical		RA	right angle (single pole only)				
Material	RoHS compliant							

STS Series, Miniature, Low Profile, THT (Continued)

Single Pole



without break, vertical

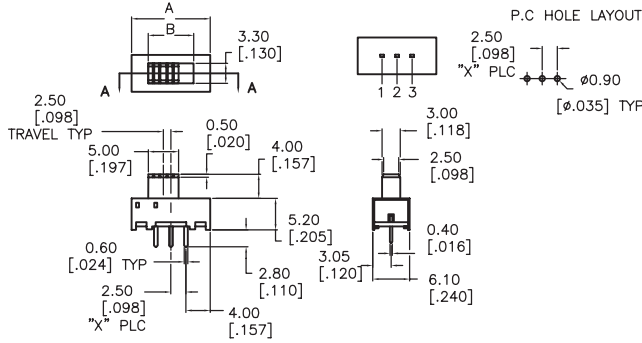

Fct	Dim A	Dim B
SPDT	13.00 (.512)	7.49 (.295)
SP3T	15.50 (.610)	10.01 (.394)
SP4T	18.01 (.709)	12.50 (.492)
SP5T	20.50 (.807)	15.01 (.591)
SP6T	23.01 (.906)	17.50 (.689)

X number of throws

without break, right angle

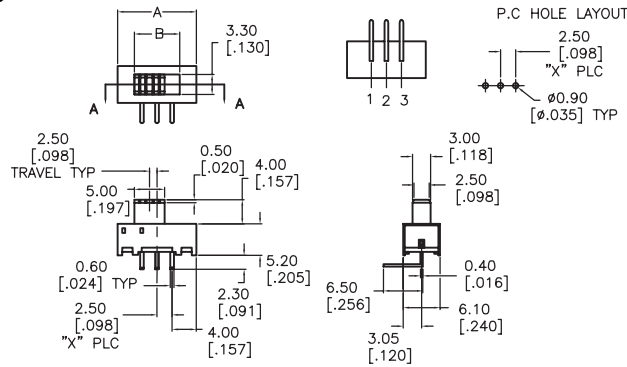

Fct	Dim A	Dim B
SPDT	13.00 (.512)	7.49 (.295)
SP3T	15.50 (.610)	10.01 (.394)
SP4T	18.01 (.709)	12.50 (.492)
SP5T	20.50 (.807)	15.01 (.591)
SP6T	23.01 (.906)	17.50 (.689)

X number of throws

with break, vertical

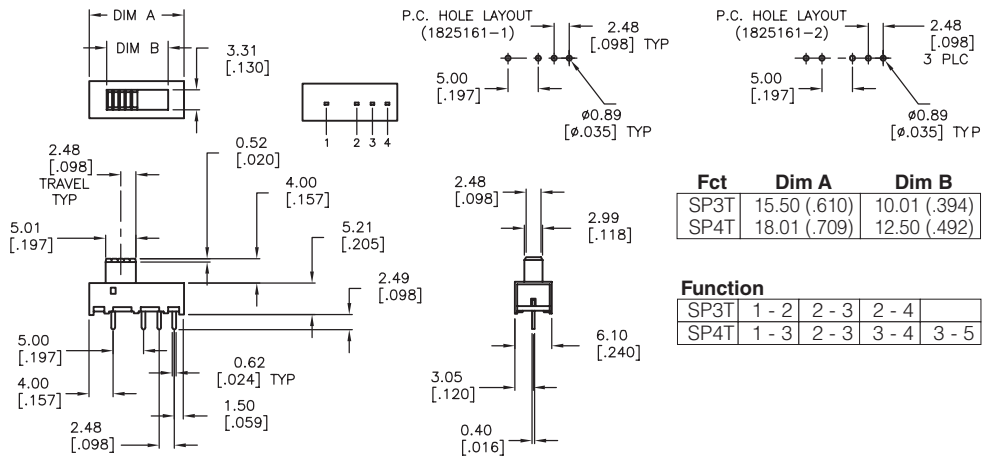

Fct	Dim A	Dim B
SP3T	15.50 (.610)	10.01 (.394)
SP4T	18.01 (.709)	12.50 (.492)

Function	1 - 2	2 - 3	2 - 4	
SP3T				
SP4T				

STS Series, Miniature, Low Profile, THT (Continued)

with break, right angle



STS1300RA

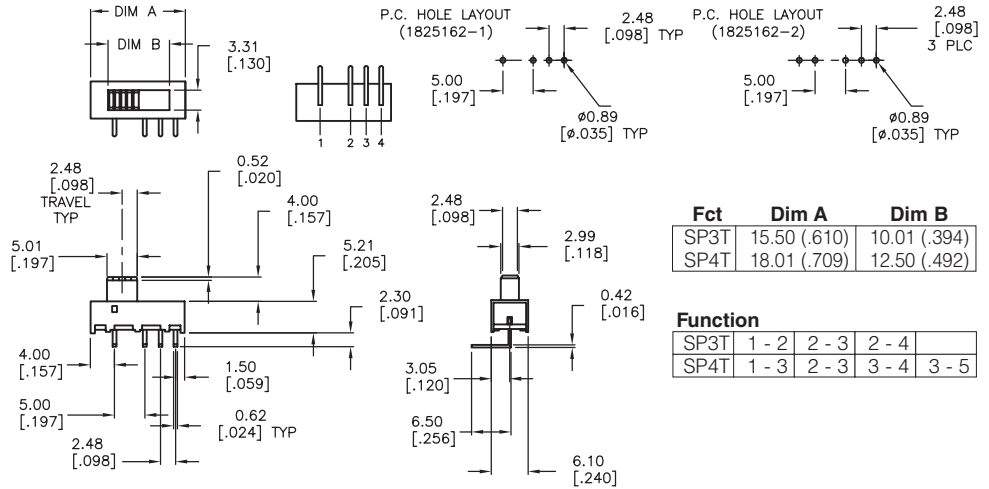

Double Pole



without break, vertical

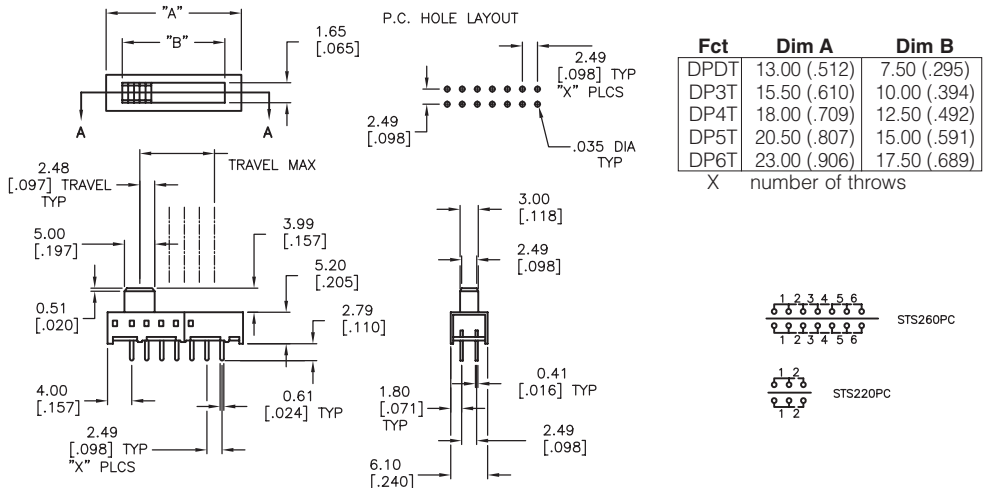

with break, vertical



STS2300PC

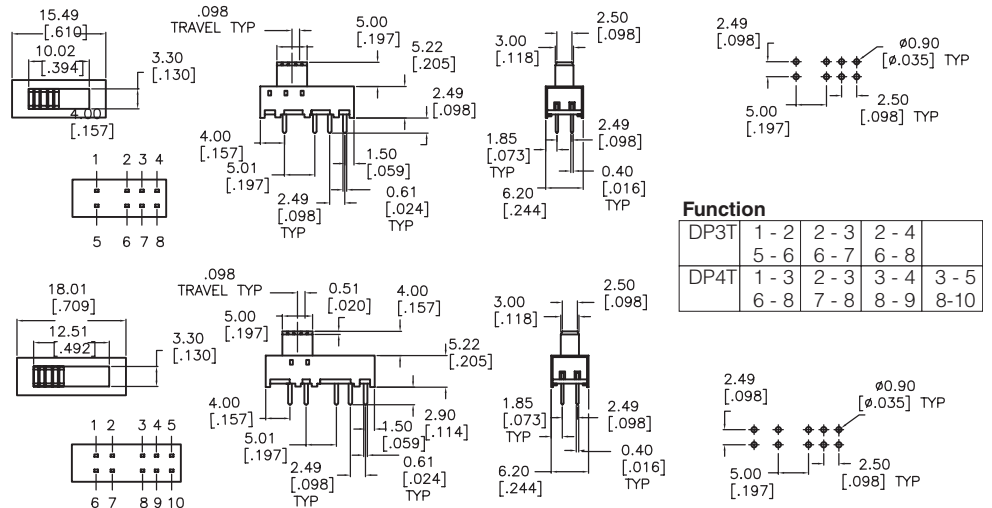

STS Series, Miniature, Low Profile, THT (Continued)

Product key	No of poles	No of throws	Pinning	Terminal	Material	Part Number
STS121PC04	single pole	2 throws	in-line spacing without break	vertical	RoHS compliant	1825159-1
STS131PC04		3 throws				1825159-2
STS141PC04		4 throws				1825159-3
STS151PC04		5 throws				1825159-4
STS161PC04		6 throws				1825159-5
STS121RA04		2 throws		right angle		1825160-1
STS131RA04		3 throws				1825160-2
STS141RA04		4 throws				1825160-3
STS151RA04		5 throws				1825160-4
STS161RA04		6 throws				1825160-5
STS1300PC04		3 throws	in-line spacing	vertical		1825161-1
STS1400PC04		4 throws	with break			1825161-2
STS1300RA04		3 throws		right angle		1825162-1
STS1400RA04		4 throws				1825162-2
STS220PC04	double pole	2 throws	dual row in-line spacing without break	vertical		1825163-1
STS230PC04		3 throws				1825163-2
STS240PC04		4 throws				1825163-3
STS250PC04		5 throws				1825163-4
STS260PC04		6 throws				1825163-5
STS2300PC04		3 throws	in-line spacing			1825164-1
STS2400PC04		4 throws	with break			1825165-1

Preferred parts in bold print

STSA Series, Miniature, Low Profile, THT

Slide Switches

Features

- Upright or right angle
- High reliability contact system
- Robust actuator for easy actuation
- Make-before-Break timing



Typical performance characteristics

Contact rating 250 milliamps @125 VAC
 Electrical life 10,000 cycles
 Mechanical life 10,000 cycles
 Contact resistance, initial max 30 mOhm, 60 mOhm (after test)
 Insulation resistance min 500 MOhm
 Dielectric strength 500 VAC for 1 min
 Actuation force 2.50 N (250 gf) average
 Actuator travel 2.49 mm (.098) average

Environmental specification

Operating temperature -10 to +60°C
 Storage temperature -10 to +60°C
 Solder heat resistance 265°C/10s wave

Material specifications

Contacts copper alloy silver finish
 Actuator pom
 Terminals copper alloy silver finish
 Case steel zinc finish
 Terminal board phenolic
 RoHS Directive 2002/95/EC compliant

Product key	Typical product key						STSA	2	2	0	RA	04
Type	STSA Miniature, low profile slide switch											
No of poles	2 double pole											
No of throws	2 two throws			3 three throws								
Version	0 standard version											
Actuation	RA right angle											
Frame	blank without posts				1 with posts							
Material	04 RoHS compliant											

STSA Series, Miniature, Low Profile, THT (Continued)

2 throws



right angle, without posts



STSA220RA

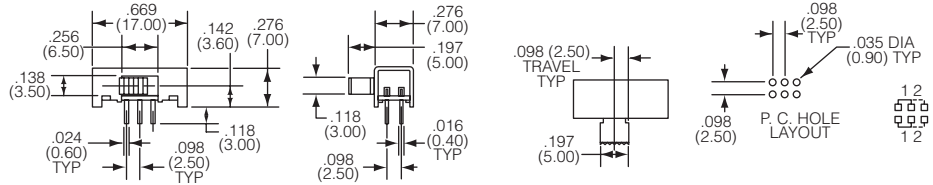

right angle, with posts



STSA220RA1

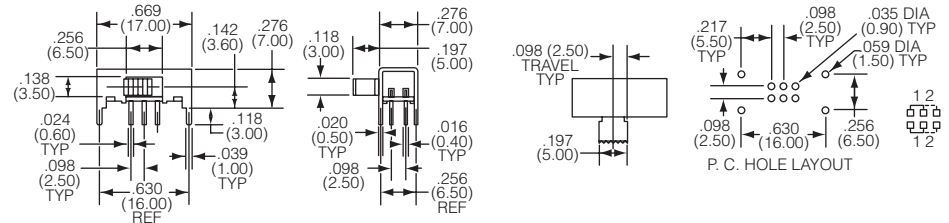

3 throws



right angle, without posts



STSA230RA

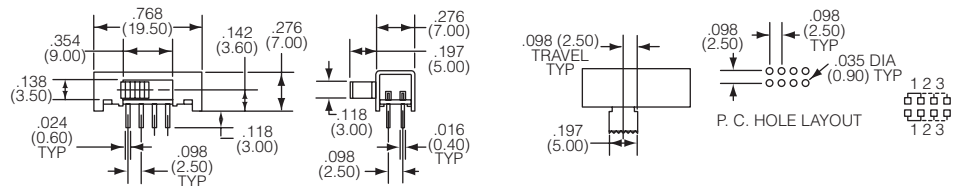

right angle, with posts



STSA230RA1

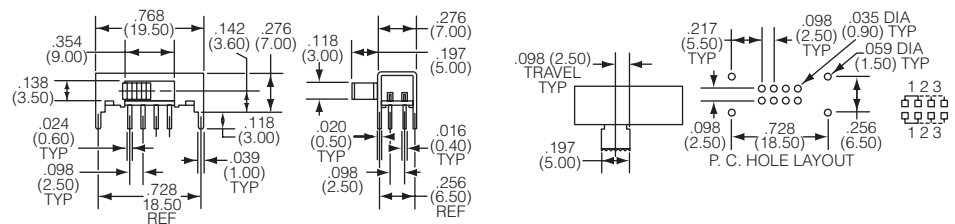

Product key	No of poles	No of throws	Terminal	Frame	Material	Part Number
STSA220RA04	double	2 throws	right angle	without posts	RoHS	1825166-1
STSA230RA04	double	3 throws	right angle	without posts	RoHS	1825166-2
STSA220RA104	single	2 throws	right angle	with posts	compliant	1825167-1
STSA230RA104	single	3 throws	right angle	with posts	compliant	1825167-2

MSSA . 01/04 Series, Instrumentation Grade, THT

Features

- 2.54 mm (.100) and 5.08 mm (.200) terminal spacing
- Upright or right angle
- Gold or silver contact finish
- Break-before-Make timing



Typical performance characteristics

Contact rating, gold: 0.4 VA @ 20 VDC or Peak AC
 silver: 3 A @ 115 VAC, 1.5 A @ 230 VAC
 Electrical life, 30,000 cycles
 Mechanical life, 30,000 cycles
 Contact resistance, initial max 20 mOhm
 Insulation resistance, min 1,000 MOhm
 Dielectric strength 500 V for 1 min
 Actuation force, 6.0 N (600 gf) average
 Actuator travel 3.05 mm (.120) average

Environmental specification

Operating temperature -20 to +65°C
 Storage temperature -40 to +100°C
 Solder heat resistance 265°C/10s wave

Material specifications

Contacts copper alloy silver or gold finish
 Actuator pps
 Terminals copper alloy silver or tin finish
 Base pbt
 Cover pbt
 RoHS Directive 2002/95/EC compliant

Product key	Typical product key	MSSA	2	0	1	D	1	04
Type	MSSA Slide switch, instrumentation grade							
No of poles	1 single pole	2	double pole					
Terminal C/L	0 2.54 mm (.100)	1	5.08 mm (.200)					
Contact finish	1 gold	4	silver					
Actuation code	D On-None-On E On-Off-On	N	On-None-On P On-Off-On					
Plating	blank silver	G	gold					
Actuator	blank extended actuator	1	flush actuator					
Actuation	blank vertical	RA	right angle					
Material	04 RoHS compliant							

MSSA . 01/04 Series, Instrumentation Grade, THT (Continued)

Single pole



terminals 2.54 mm (.100), extended actuator, vertical



MSSA104D

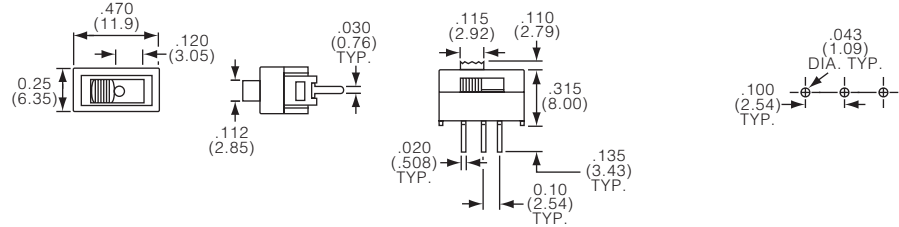

terminals 5.08 mm (.200), extended actuator, vertical



MSSA114D

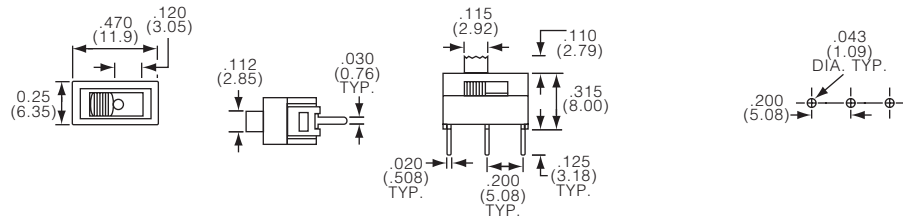

terminals 2.54 mm (.100), flush actuator



MSSA104D1

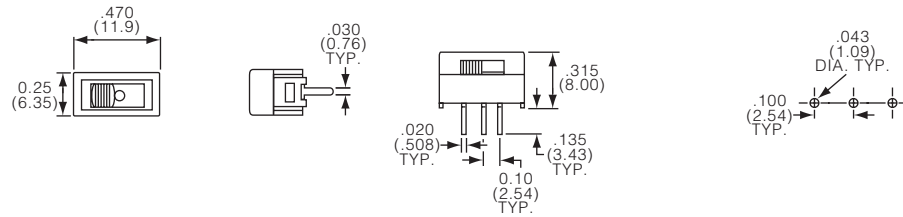

terminals 2.54 mm (.100), extended actuator, right angle



MSSA104DGRA

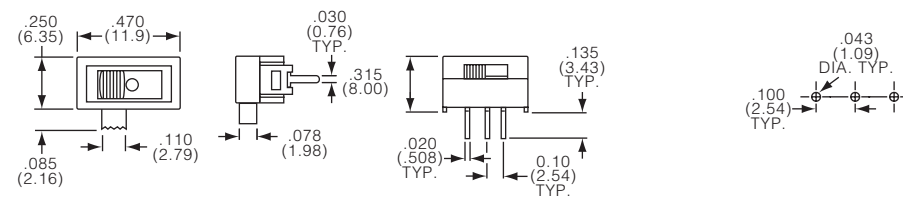

Double pole



terminals 2.54 mm (.100), extended actuator, vertical



MSSA204N

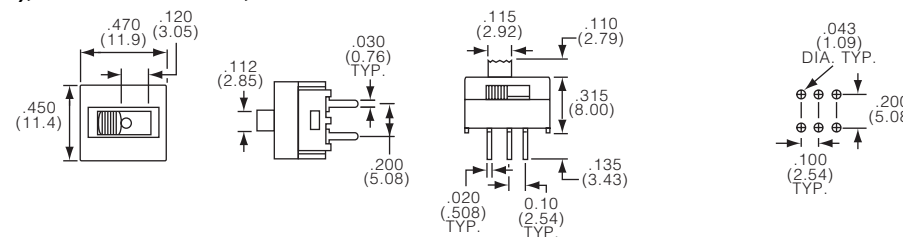

Slide Switches

MSSA . 01/04 Series, Instrumentation Grade, THT (Continued)

Slide Switches

terminals 5.08 mm (.200), extended actuator, vertical



MSSA214N

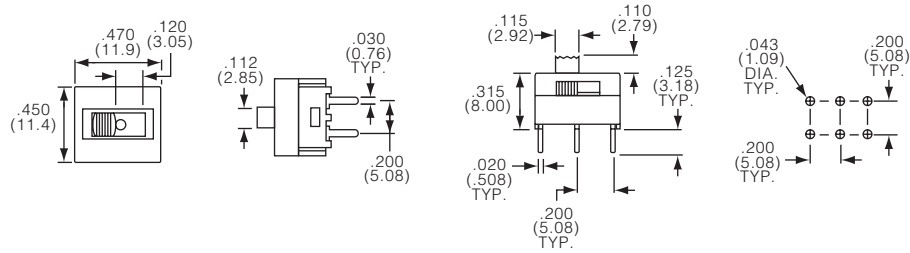

terminals 2.54 mm (.100), flush actuator



MSSA204N1

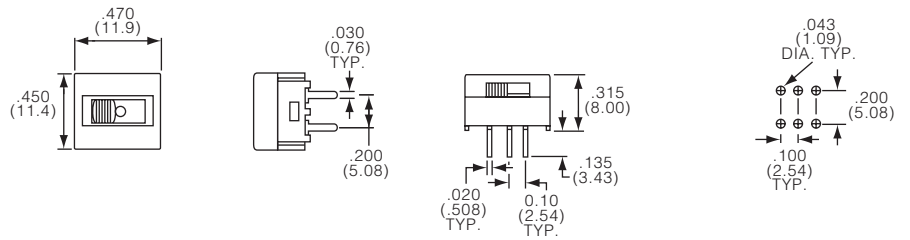

terminals 2.54 mm (.100), extended actuator, right angle



MSSA204NRA

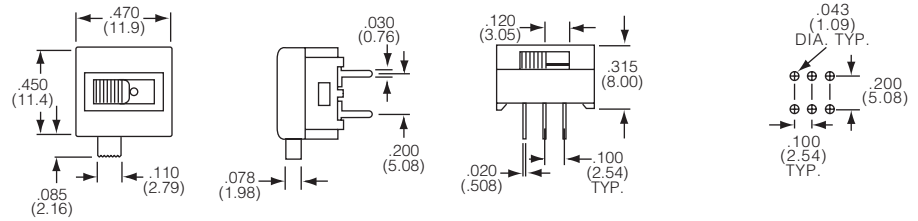

terminals 5.08 mm (.200), extended actuator, right angle

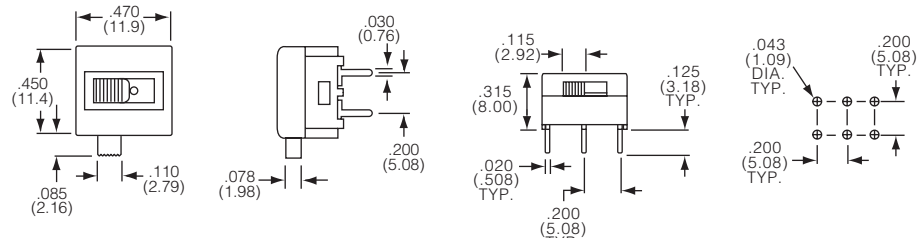

Actuation code



Codes D, E, N, P

D On-None-On



NONE



E On-Off-On



N On-None-On

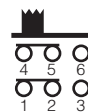

NONE

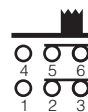

P On-Off-On

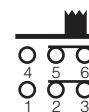
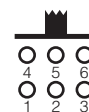
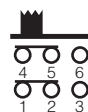

MSSA . 01/04 Series, Instrumentation Grade, THT (Continued)

Product key	Poles	Terminal	Contacts	Actuation	Plating	Actuator	Actuation	Material	Part Number
MSSA101DG04	single pole	2.54 mm (.100)	gold	On-None-On	gold	extended	vertical	RoHS compliant	1-1437580-7
MSSA101DG104						flush			1-1437580-8
MSSA101DGRA04				On-Off-On		extended	right angle		1-1437580-9
MSSA101EGRA04									2-1437580-1
MSSA104D04			silver	On-None-On	silver		vertical		2-1437580-3
MSSA104D104						flush		2-1437580-4	
MSSA104DRA04						extended	right angle		2-1437580-5
MSSA104E04				On-Off-On			vertical		2-1437580-6
MSSA111DG04		5.08 mm (.200)	gold	On-None-On	gold				2-1437580-9
MSSA111EG04							On-Off-On		
MSSA114D04			silver	On-None-On	silver				3-1437580-1
MSSA114E04							On-Off-On		
MSSA201NG04	double pole	2.54 mm (.100)	gold	On-None-On	gold				4-1437580-1
MSSA201NGRA04								right angle	
MSSA204N04			silver		silver		vertical		4-1437580-4
MSSA204N104									vertical
MSSA204NRA04							right angle		4-1437580-6
MSSA204P04				On-Off-On			vertical		4-1437580-7
MSSA204P104						flush			4-1437580-8
MSSA211NG04		5.08 mm (.200)	gold	On-None-On	gold	extended			4-1437580-9
MSSA211NGRA04									
MSSA211PG04				On-Off-On			vertical		5-1437580-1
MSSA214N04			silver	On-None-On	silver				5-1437580-2

Preferred parts in bold print

MMS Series, Micro Size, Instrumentation Grade, THT

Features

- Upright or right angle
- Make-before-Break timing



Slide Switches

Typical performance characteristics

Contact rating 100 milliamps @ 30 VDC
 Electrical life 10.000 cycles
 Mechanical life 10.000 cycles
 Contact resistance, initial max 30 mOhm, 60 mOhm (after test)
 Insulation resistance min 100 MOhm
 Dielectric strength 500 VAC for 1 min
 Actuation force 2.0 N (200 gf) average
 Actuator travel 2.00 mm (.079) average
 MMS12: 2.50 mm (.098) average

Environmental specification

Operating temperature -10 to +60°C
 Storage temperature -10 to +60°C
 Solder heat resistance 265°C/10s wave

Material specifications

Contacts copper alloy silver finish
 Actuator polyacetal
 Terminals copper alloy silver finish
 Base nylon
 Cover polyacetal
 RoHS Directive 2002/95/EC compliant

Product key

Typical product key

MMS 2 2

Type
MMS Slide switch, micro size, instrumentation grade

No of poles
1 single pole
2 double pole
4 4 pole

No of throws
2 2 throws
3 3 throws

Actuation
blank vertical
R right angle

MMS Series, Micro Size, Instrumentation Grade, THT (Continued)

Single Pole



double throw, vertical



MMS12

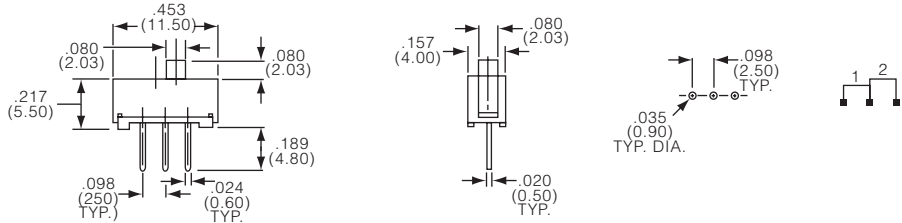

Double Pole



double throw, vertical



MMS22

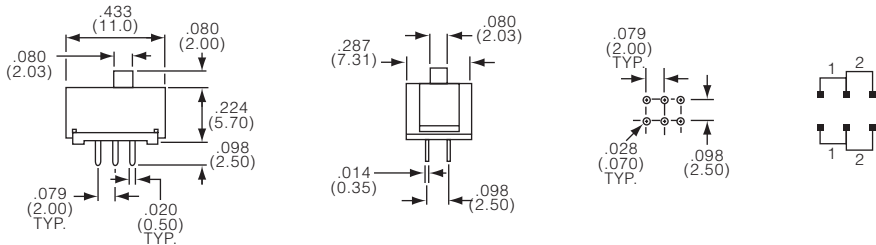

double throw, right angle



MMS22R

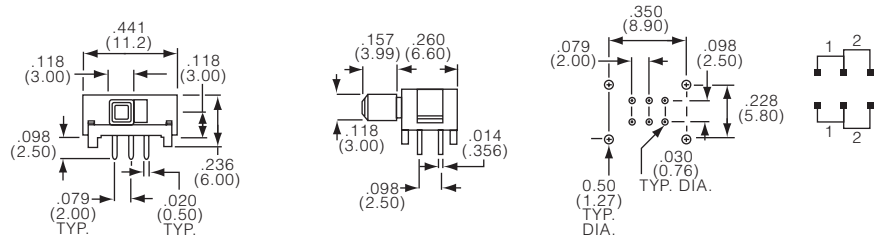

triple throw, vertical



MMS23

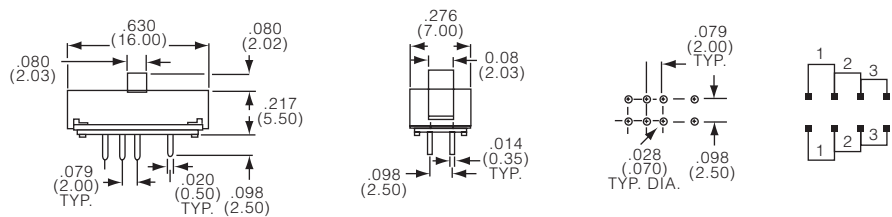

triple throw, right angle



MMS23R

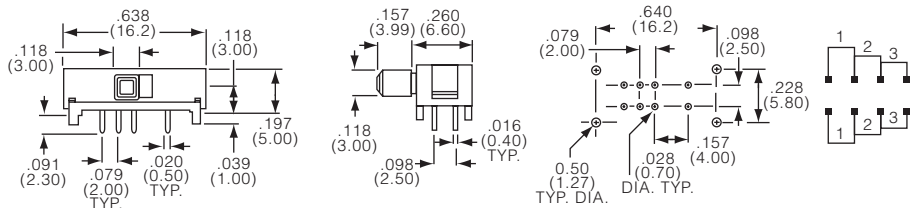

MMS Series, Micro Size, Instrumentation Grade, THT (Continued)

4 Pole



double throw, vertical



MMS42

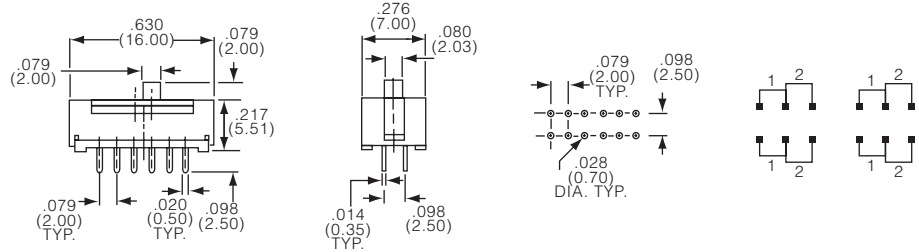

double throw, right angle



MMS42R

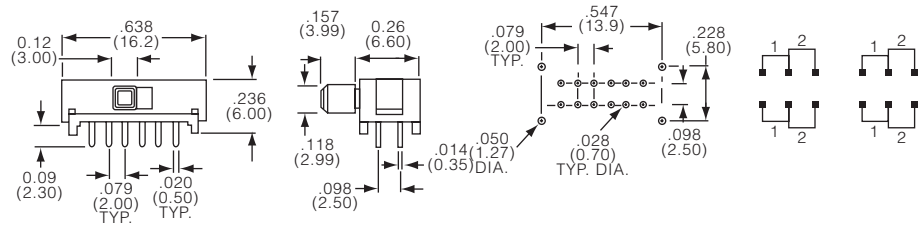

triple throw, vertical

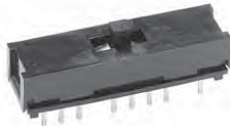

MMS43

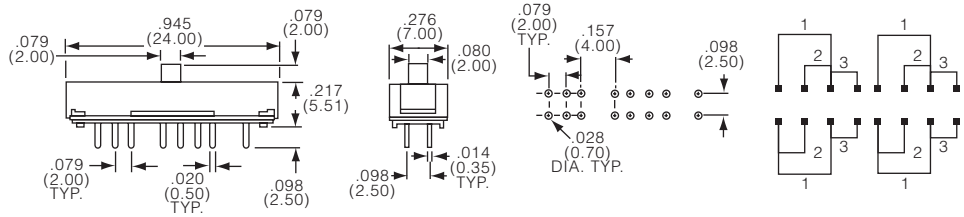

triple throw, right angle



MMS43R

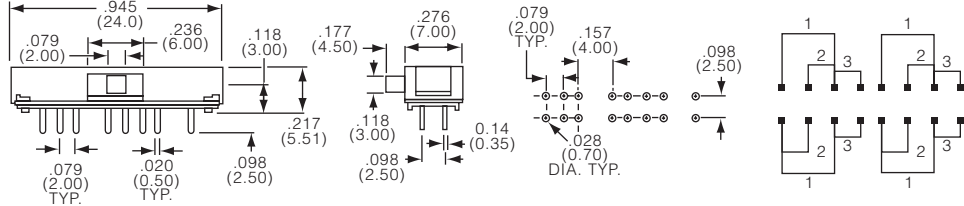

Product key	No of poles	No of throws	Actuation	Part Number
MMS12	single pole	2 throws	vertical	1437575-4
MMS22	double pole			1437575-5
MMS22R			right angle	1437575-6
MMS23		3 throws	vertical	1437575-8
MMS23R			right angle	1437575-9
MMS42	4 pole	2 throws	vertical	1-1437575-0
MMS42R			right angle	1-1437575-1
MMS43		3 throws	vertical	1-1437575-2

TSS Series, Single or Dual Actuator, THT

Features

- Break-before-Make timing
- Vertical or right angle versions

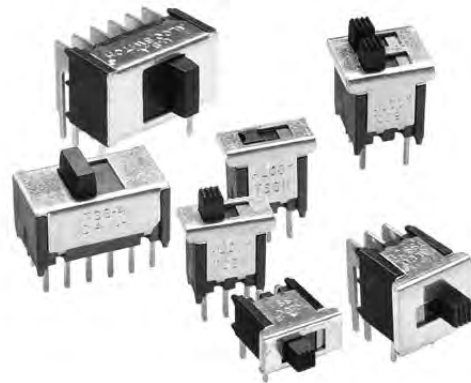

Slide Switches

Typical performance characteristics

Contact rating..... 0.4 VA @ 20 VDC or peak AC
 Electrical life..... 80,000 cycles
 Mechanical life..... 80,000 cycles
 Contact resistance, initial max 20 mOhm, 60 mOhm (after test)
 Insulation resistance..... min 1,000 MOhm
 Dielectric strength 1,000 VAC for 1 min
 Actuation force 1.50 to 8.0 N (150 to 800 gf)
 Actuator travel..... 3.05 mm (.120) average

Environmental specification

Operating temperature -20 to +80°C
 Storage temperature -20 to +80°C
 Solder heat resistance..... 265°C/10s Wave

Material specifications

Contacts copper alloy gold finish
 Actuator pbt
 Terminals copper alloy tin finish
 Case lcp
 Frame steel tin finish
 RoHS Directive 2002/95/EC compliant

Product key	Typical product key		TS	S	1	1	D	G	PC	04
Type	Slide switch									
No of actuators	S single actuator	D dual actuator								
No of poles	1 single pole	2 double pole								
		4 4 pole								
Version	1 standard version									
Actuation code	D On-None-On	P On-Off-On								
	E On-Off-Off	DD (dual) On-None-Off-On								
	K On-None-Off	EE (dual) On-Off-On								
	N On-None-On									
Actuator version	G standard version									
Actuator	blank extended actuator	1 flush actuator								
Terminal	PC vertical	RA right angle								
Material	04 RoHS compliant									

TSS Series, Single or Dual Actuator, THT (Continued)

Single actuator, single pole



extended actuator, vertical



TSS11DGPC

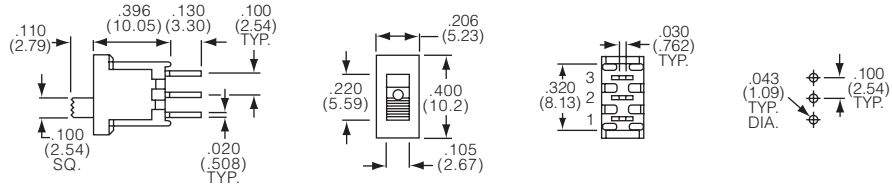

flush actuator, vertical



TSS11DG1PC

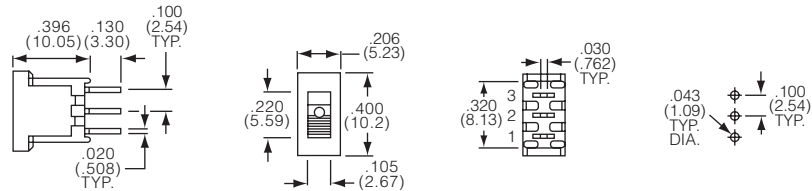

extended actuator, right angle



TSS11DGRA

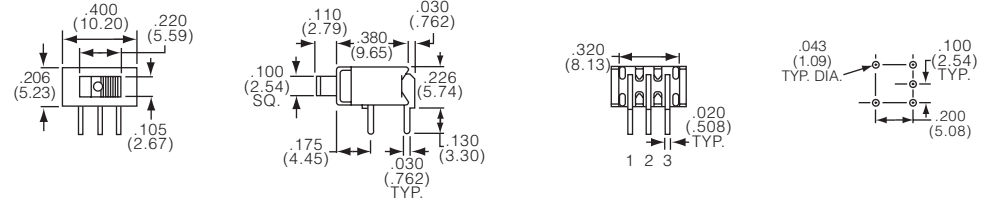

flush actuator, right angle



TSS11DG1RA

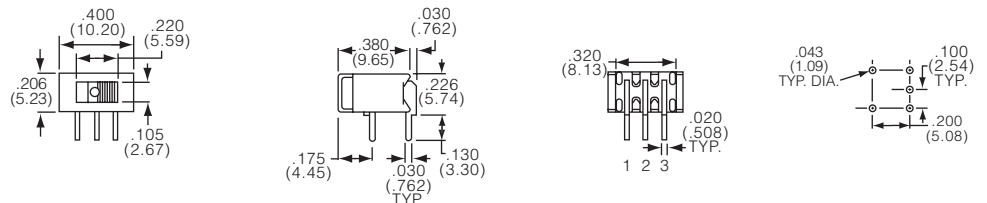

Single actuator, double pole



extended actuator, vertical



TSS21NGPC

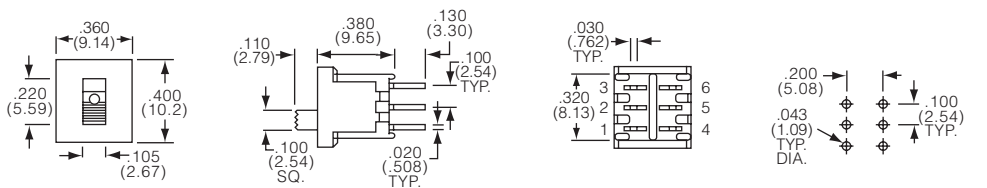

TSS Series, Single or Dual Actuator, THT (Continued)

flush actuator, vertical

TSS21NG1PC

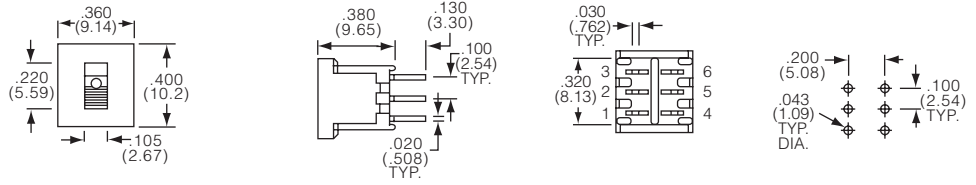

extended actuator, right angle

TSS21NGRA

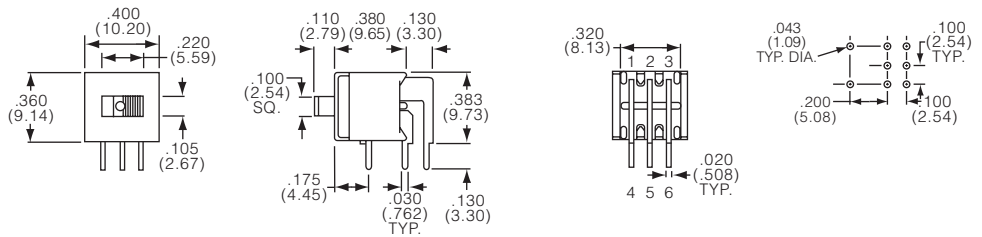

flush actuator, right angle

TSS21NG1RA

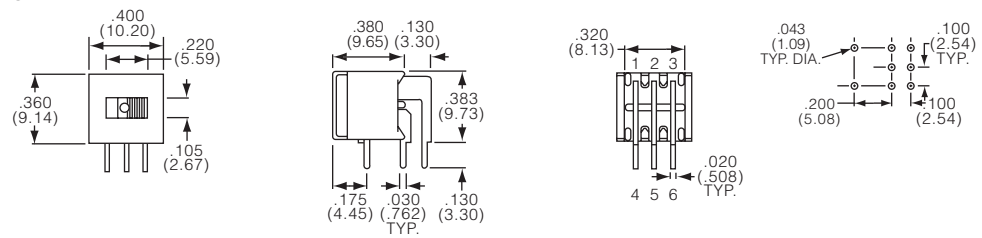

Single actuator, 4 pole



extended actuator, vertical

TSS41NGPC

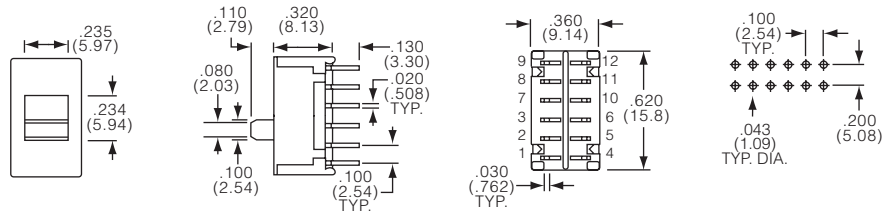

extended actuator, right angle

TSS41NGRA

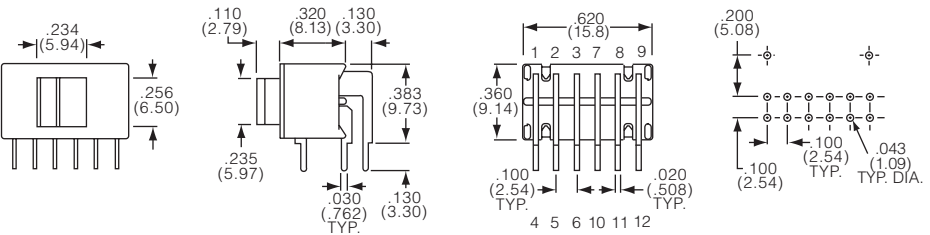

TSS Series, Single or Dual Actuator, THT (Continued)

Slide Switches

Dual actuator, single pole



extended actuator, vertical



TSD21DDGPC

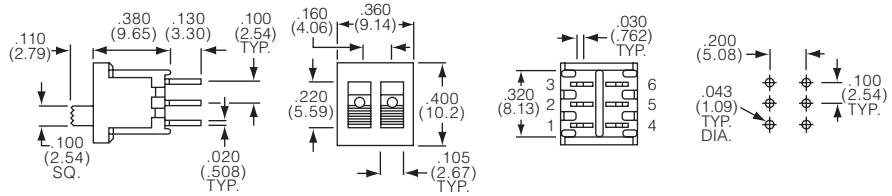

flush actuator, vertical



TSD21DDG1PC

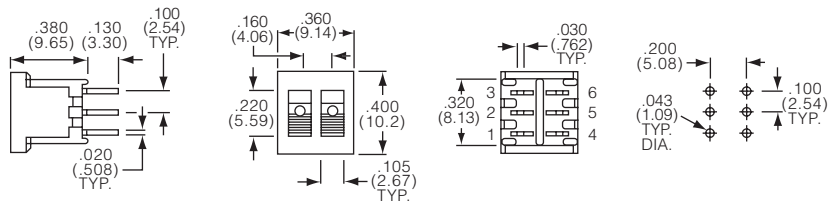

extended actuator, right angle



TSD21DDGRA

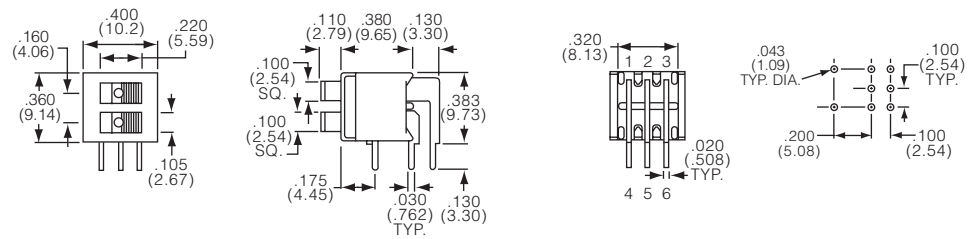

flush actuator, right angle



TSD21DDG1RA

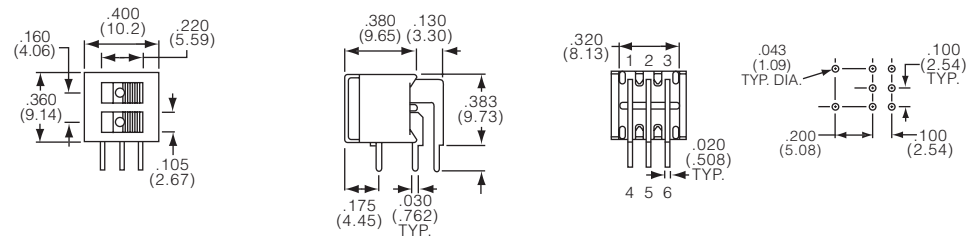

TSS Series, Single or Dual Actuator, THT (Continued)

Actiation code

Codes D, E, K, N, P, DD, EE

D On-None-On



E On-Off-On

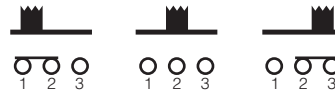

K On-None-Off



N On-None-On



P On-Off-On

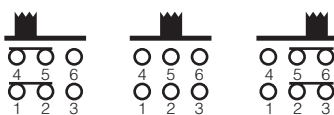

DD Dual actuator, On-None-On



EE Dual actuator, On-Off-On

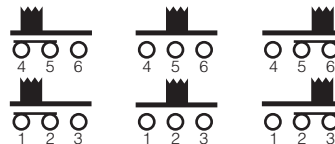

Product key	No of actuators	No of poles	Actuation code	Actuator	Terminal	Material	Part Number
TSD21DDG1RA04	dual actuator	2 x single pole	On-None-On	flush	right angle	RoHS compliant	1825014-3
TSD21DDGPC04				extended	vertical		1825015-1
TSD21DDGRA04					right angle		1825014-1
TSD21EEGRA04			On-Off-On				1825014-2
TSS11DG1PC04	single actuator	single pole	On-None-On	flush	vertical		1571982-1
TSS11DG1RA04					right angle		1571985-1
TSS11DGPC04				extended	vertical		1571982-2
TSS11DGRA04					right angle		1571984-1
TSS11EG1PC04			On-Off-On	flush	vertical		1571982-3
TSS11EG1RA04					right angle		1571985-2
TSS11EGPC04				extended	vertical		1571982-4
TSS11EGRA04					right angle		1571984-2
TSS21KGPC04		double pole	On-None-Off		vertical		1571982-5
TSS21NG1PC04			On-None-On	flush			1571982-6
TSS21NG1RA04					right angle		1571985-3
TSS21NGPC04				extended	vertical		1571982-7
TSS21NGRA04					right angle		1571984-3
TSS21PG1PC04			On-Off-On	flush	vertical		1571982-8
TSS21PG1RA04					right angle		1571985-4
TSS21PGPC04				extended	vertical		1571982-9
TSS21PGRA04					right angle		1571984-4
TSS41NGPC		4 pole	On-None-On		vertical		2-1437579-5
TSS41NGRA					right angle		2-1437579-7

Preferred parts in bold print

MHS Series, Low Profile, Instrumentation Grade, THT

Slide Switches

Features

- Upright or right angle
- Gold or silver contact finish
- Various actuator styles
- Make-before-Break timing



Typical performance characteristics

Contact rating, gold: 0.4 VA @ 20 VDC or Peak AC
 silver: 300 milliamp @ 125 VAC
 Electrical life. 15,000 cycles
 Mechanical life. 15,000 cycles
 Contact resistance, initial max 30 mOhm, 100 mOhm (after test)
 Insulation resistance. min 1,000 MOhm
 Dielectric strength 500 V for 1 min
 Actuation force. 6.0 N (600 gf) average
 Actuator travel 2.00 mm (.079) average
 MHS122: 4.00 mm (.157) average

Environmental specification

Operating temperature -20 to +85°C
 Storage temperature -40 to +100°C
 Solder heat resistance. 265°C/10s wave

Material specifications

Contacts copper alloy silver or gold finish
 Actuator. pom
 Terminals. copper alloy silver or gold finish
 Frame steel nickel finish
 Terminal board phenolic
 RoHS Directive 2002/95/EC compliant

Product key	Typical product key						MHS	1	3	3	K	G	04
Type	MHS Slide switch, low profile, instrumentation grade												
No of poles	1 single pole	2 double pole											
No of throws	2 2 throws	3 3 throws											
No of positions	2 2 positions	3 3 positions											
Actuator	blank standard	K baton											
Contact finish	blank silver	G gold											
Actuation	blank vertical	RA right angle											
Material	04 RoHS compliant												

MHS Series, Low Profile, Instrumentation Grade, THT (Continued)

Single pole



double throw, vertical

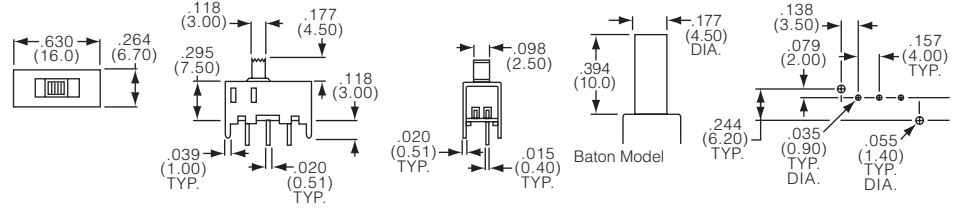

double throw, right angle

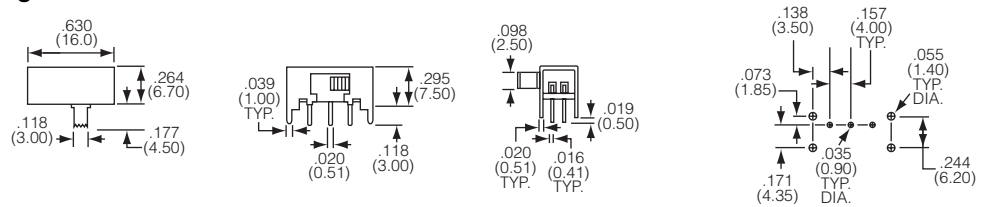

triple throw, vertical

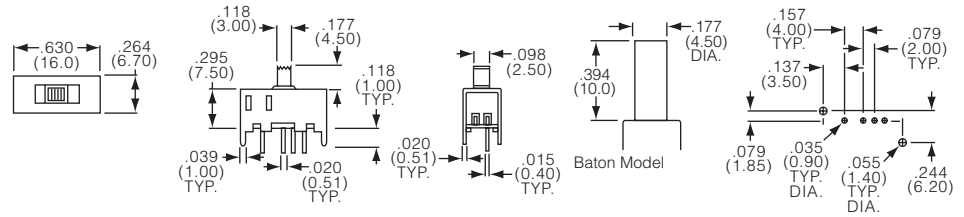
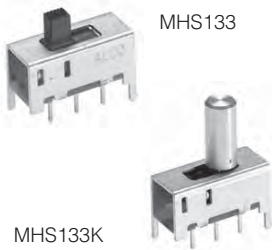



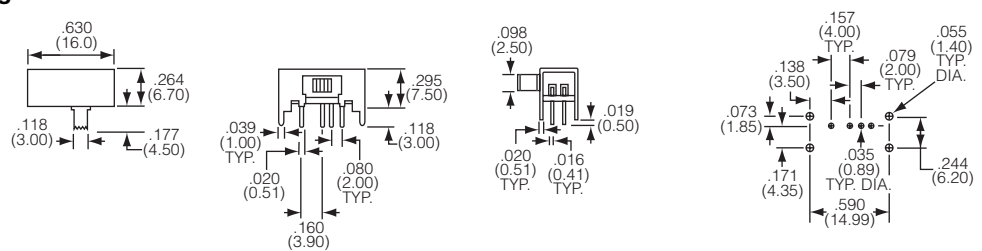



triple throw, right angle



MHS Series, Low Profile, Instrumentation Grade, THT (Continued)

Function

Poles	Throws	Positions	Function
1	2	2	
1	2	3	
1	3	3	
2	2	2	
2	2	3	
2	3	3	

Slide Switches

Product key	No of poles	No of throws	No of positions	Actuator	Contact finish	Material	Part Number
MHS12204	single pole	2 throws	2 positions	standard	silver	RoHS compliant	1825255-1
MHS122G04					gold		1825255-2
MHS122GRA04							1825256-4
MHS122K04				baton	silver		1825255-3
MHS122KG04					gold		1825255-4
MHS122RA04				standard	silver		1825256-1
MHS12304			3 positions				1825255-5
MHS123GRA04						gold	1825256-5
MHS123K04				baton	silver		1825255-6
MHS123RA04				standard			1825256-2
MHS13304		3 throws					1825255-7
MHS133G04						gold	1825255-8
MHS133GRA04							1825256-6
MHS133K04				baton	silver		1825255-9
MHS133KG04							1-1825255-0
MHS133RA04				standard			1825256-3
MHS22204	double pole	2 throws	2 positions				1825289-1
MHS222G04					gold	1825289-2	
MHS222GRA04							1825290-4
MHS222K04				baton	silver		1825289-3
MHS222KG04					gold		1825289-4
MHS222RA04				standard	silver		1825290-1
MHS22304			3 positions				1825289-5
MHS223G04						gold	1825289-6
MHS223GRA04							1825290-5
MHS223K04				baton	silver		1825289-7
MHS223RA04				standard			1825290-2
MHS23304		3 throws					1825289-8
MHS233G04						gold	1825289-9
MHS233GRA04							1825290-6
MHS233K04				baton	silver		1-1825289-0
MHS233KG04							1-1825289-1
MHS233RA04				standard			1825290-3

Preferred parts in bold print

MSS Series, Instrumentation Grade, THT

Slide Switches

Features

- Upright or right angle
- Gold or silver contact finish
- Various actuator heights
- Make-before-Break timing

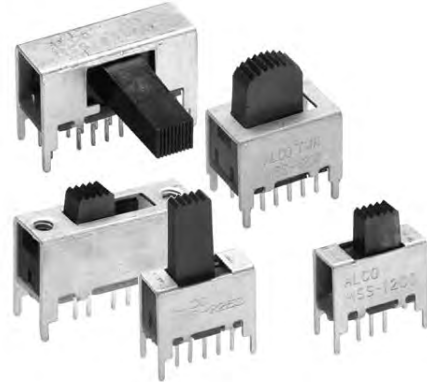

Typical performance characteristics

Contact rating, gold: 0.4 VA @ 20 VDC or peak AC
 silver: 300 milliamp @ 125 VAC
 Electrical life, 15,000 cycles
 Mechanical life, 15,000 cycles
 Contact resistance, initial max 30 mOhm, 100 mOhm (after test)
 Insulation resistance, min 1,000 MOhm
 Dielectric strength 500 V for 1 min
 Actuation force, 6.0 N (600 gf) average
 Actuator travel 2.0 mm (.079) average

Environmental specification

Operating temperature -20 to +85°C
 Storage temperature -40 to +100°C
 Solder heat resistance 265°C/10s wave

Material specifications

Contacts copper alloy silver or gold finish
 Actuator, pom
 Terminals, copper alloy silver or gold finish
 Frame steel nickel finish
 Terminal board phenolic
 RoHS Directive 2002/95/EC compliant

Product key	Typical product key		MSS	1	2	00	R	G	04
Type	MSS Slide switch, instrumentation grade								
No of poles	1 single pole	4 4 pole							
	2 double pole	6 6 pole							
No of throws	2 2 throws	4 4 throws							
	3 3 throws								
Actuator length	00 standard	35 xx-long							
	25 x-long	50 xxx-long							
Actuation	blank vertical	R right angle							
Contact finish	blank silver	G gold							
Material	04 RoHS compliant								

MSS Series, Instrumentation Grade, THT (Continued)

Single pole



2 throws, standard actuator length, vertical



MSS1200

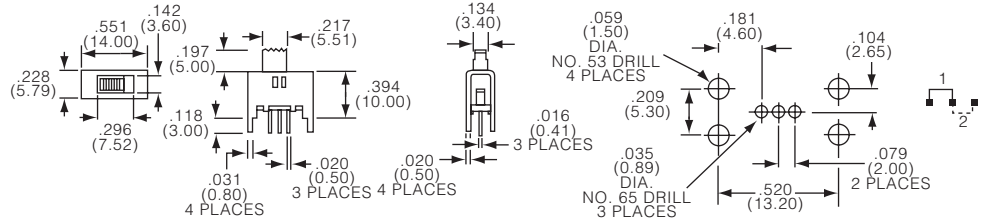

2 throws, standard actuator length, right angle



MSS1200R

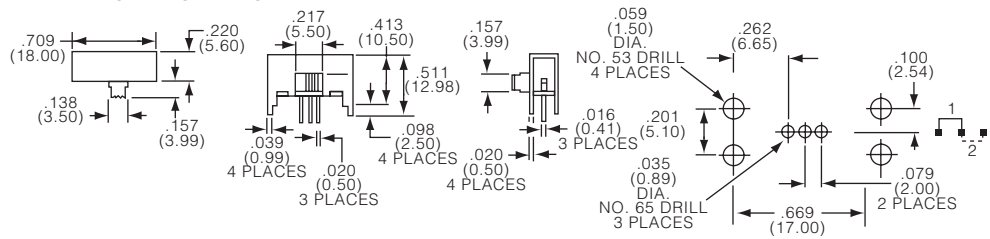

3 throws, standard actuator length, vertical



MSS1300

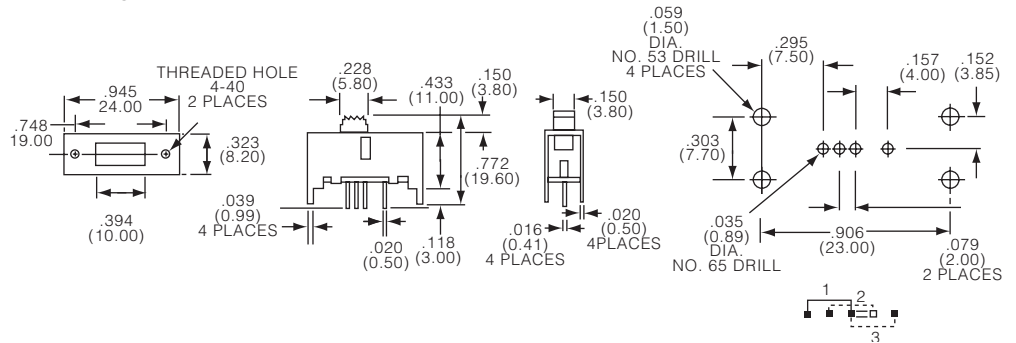

3 throws, standard actuator length, right angle



MSS1300R

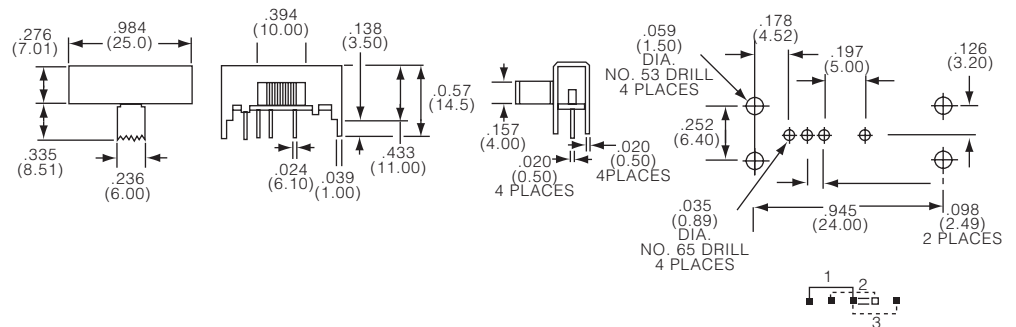

MSS Series, Instrumentation Grade, THT (Continued)

4 throws, standard actuator length, vertical



MSS1400

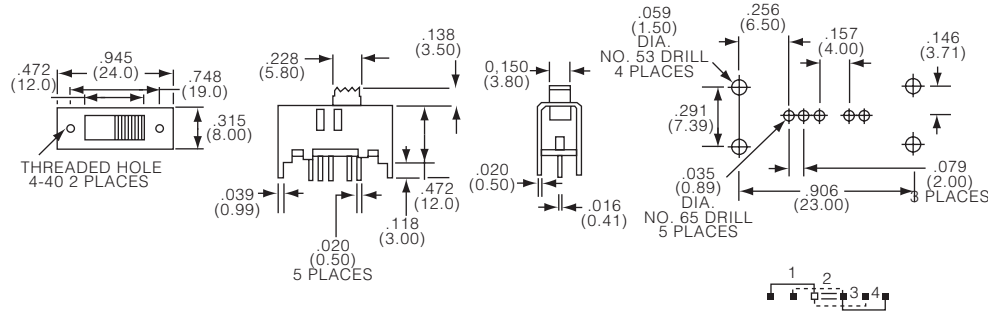

Slide Switches

Double pole



2 throws, x-long actuator, vertical



MSS2225

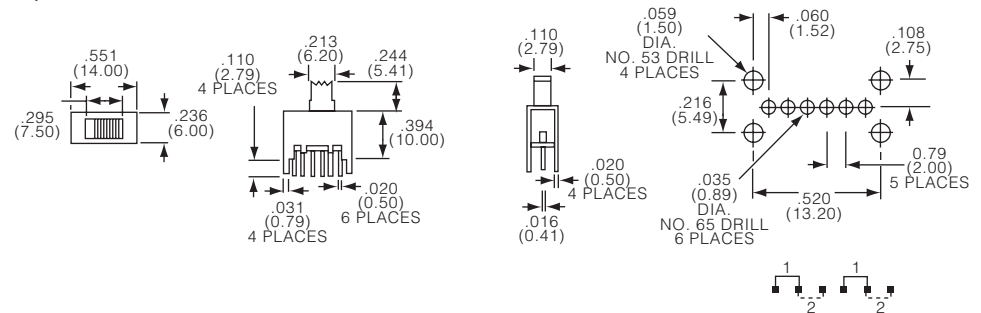

2 throws, xxx-long actuator, vertical



MSS2250

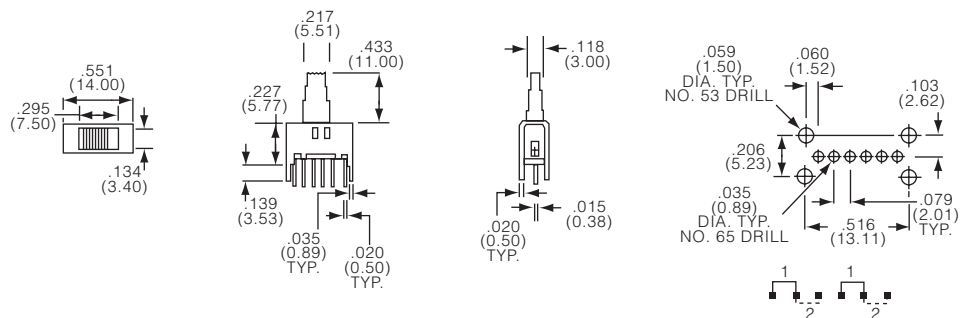

2 throws, xxx-long actuator, right angle



MSS2250R

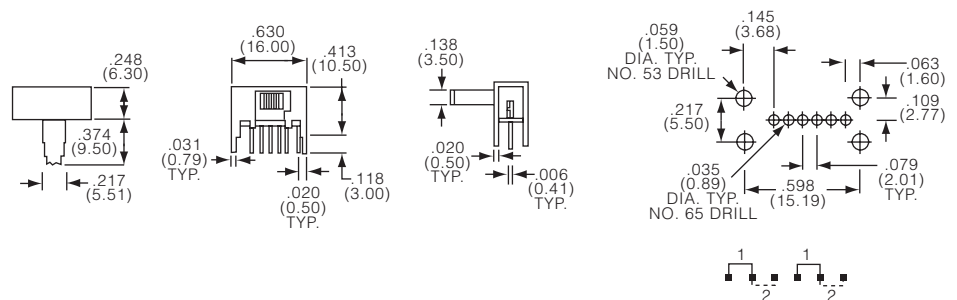

MSS Series, Instrumentation Grade, THT (Continued)

4 poles



2 throws, xxx-long actuator, vertical



MSS4200

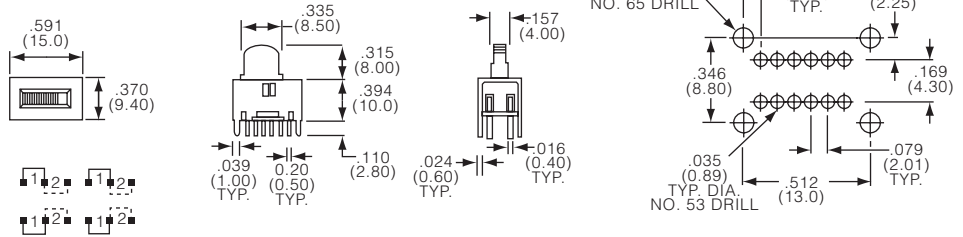

2 throws, standard actuator length, right angle



MSS4250

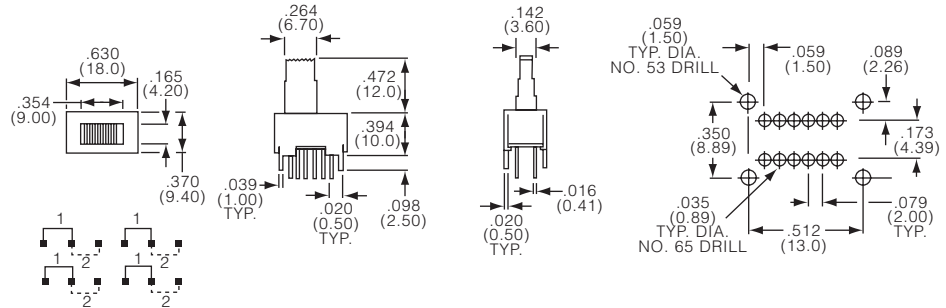

3 throws, standard actuator length, vertical



MSS4300

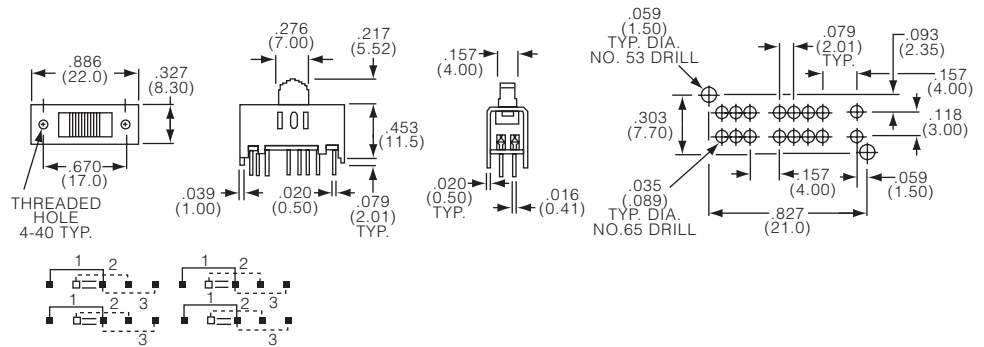

3 throws, xx-long actuator, vertical



MSS4335

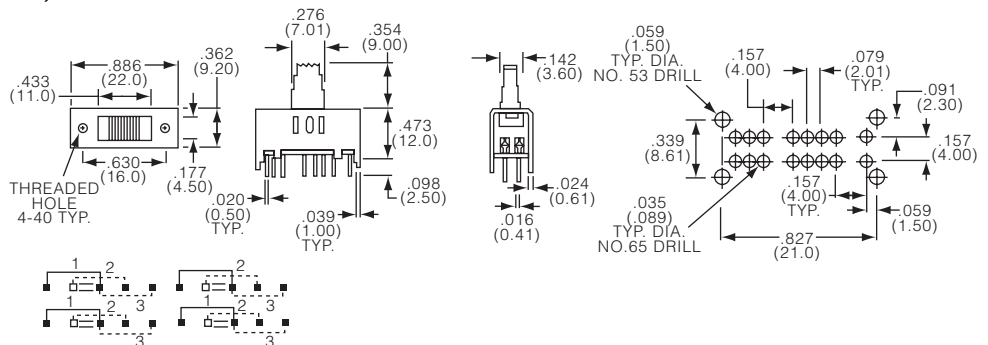

MSS Series, Instrumentation Grade, THT (Continued)

Slide Switches

3 throws, standard actuator length, right angle



MSS4300R

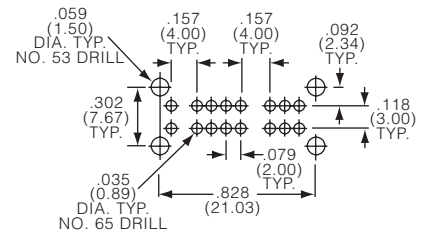
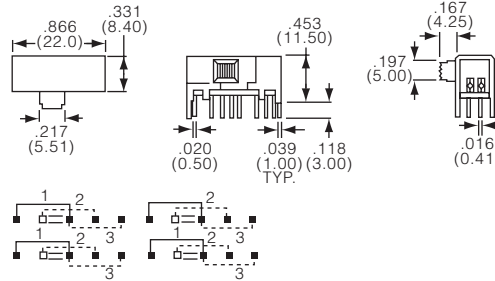

3 throws, xxx-long actuator length, right angle



MSS4350R

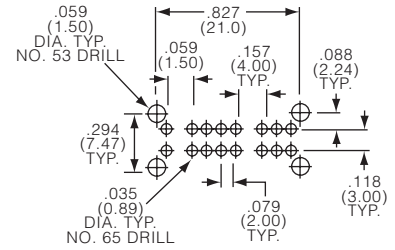
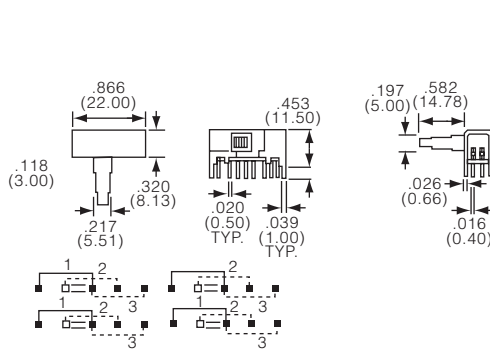

6 poles



2 throws, standard actuator length, vertical



MSS6200

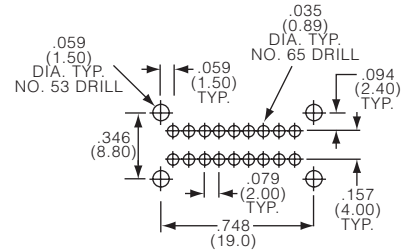
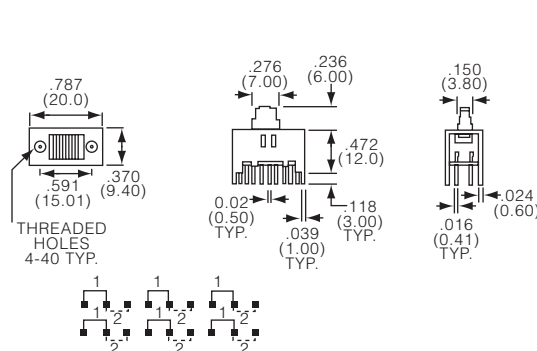

2 throws, xxx-long actuator, vertical



MSS6250

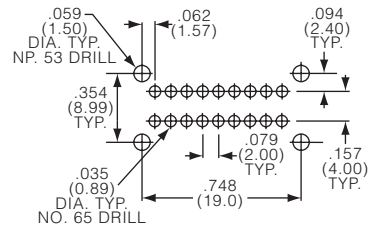
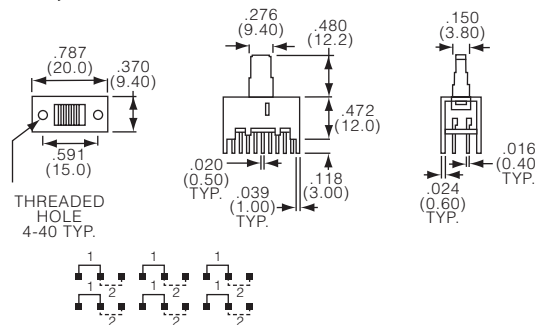

MSS Series, Instrumentation Grade, THT (Continued)

3 throws,xxx-long actuator, vertical

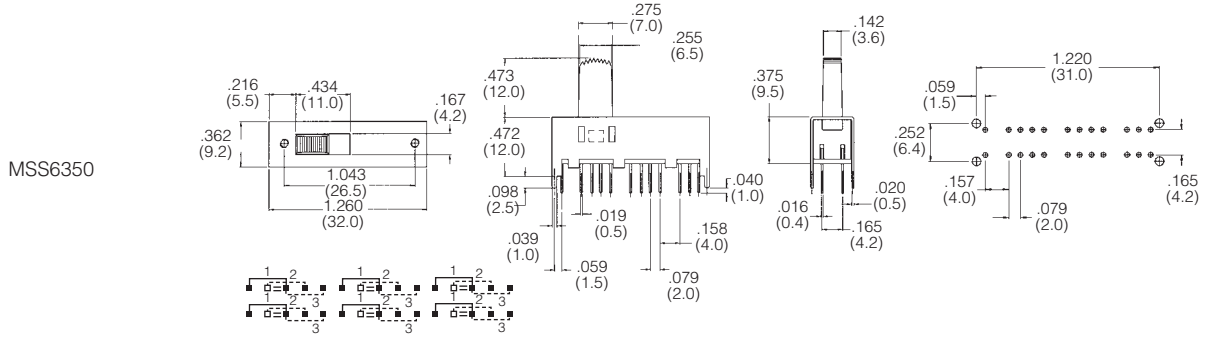

3 throws, xxx-long actuator, right angle

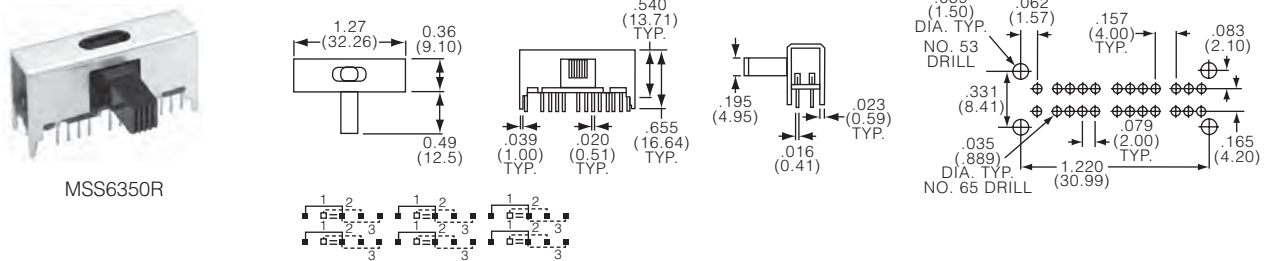

Product key	No of poles	No of throws	Actuator length	Actuation	Contact finish	Material	Part Number
MSS120004	single pole	2 throws	standard	vertical	silver	RoHS compliant	1825257-1
gold					1825257-2		
silver					1825258-1		
MSS1200R04	double pole	2 throws	xxx-long	right-angle	gold	RoHS compliant	1825258-2
silver					1825259-1		
gold					1825259-2		
MSS130004	4 pole	3 throws	standard	vertical	silver	RoHS compliant	1825260-1
gold					1825260-2		
silver					1825260-3		
MSS1300G04	4 pole	3 throws	xxx-long	right-angle	gold	RoHS compliant	1825261-1
silver					1825261-2		
gold					1825261-3		
MSS140004	4 pole	4 throws	standard	vertical	silver	RoHS compliant	1825262-1
gold					1825262-2		
silver					1825262-3		
MSS220004	4 pole	2 throws	xxx-long	right-angle	gold	RoHS compliant	1825263-1
silver					1825263-2		
gold					1825263-3		
MSS2200G04	4 pole	2 throws	xxx-long	right-angle	silver	RoHS compliant	1825264-1
gold					1825264-2		
silver					1825264-3		
MSS222504	4 pole	3 throws	standard	vertical	gold	RoHS compliant	1825265-1
silver					1825265-2		
gold					1825265-3		
MSS2225G04	4 pole	3 throws	xxx-long	right-angle	silver	RoHS compliant	1825266-1
gold					1825266-2		
silver					1825266-3		
MSS225004	4 pole	2 throws	standard	vertical	gold	RoHS compliant	1825267-1
silver					1825267-2		
gold					1825267-3		
MSS2250G04	4 pole	2 throws	xxx-long	right-angle	silver	RoHS compliant	1825268-1
gold					1825268-2		
silver					1825268-3		
MSS2250R04	4 pole	2 throws	standard	vertical	gold	RoHS compliant	1825269-1
silver					1825269-2		
gold					1825269-3		
MSS2250RG04	4 pole	2 throws	xxx-long	right-angle	silver	RoHS compliant	1825270-1
gold					1825270-2		
silver					1825270-3		
MSS420004	6 pole	2 throws	standard	vertical	gold	RoHS compliant	1825271-1
silver					1825271-2		
gold					1825271-3		
MSS4200G04	6 pole	2 throws	xxx-long	right-angle	silver	RoHS compliant	1825272-1
gold					1825272-2		
silver					1825272-3		
MSS4200R04	6 pole	3 throws	standard	vertical	gold	RoHS compliant	1825273-1
silver					1825273-2		
gold					1825273-3		
MSS4200RG04	6 pole	3 throws	xxx-long	right-angle	silver	RoHS compliant	1825274-1
gold					1825274-2		
silver					1825274-3		

Preferred parts in bold print

MSSA Series, Instrumentation Grade, THT

Slide Switches

Features

- Upright or right angle
- Gold or silver contact finish
- Make-before-Break timing
- Multiple pole and throw options



Typical performance characteristics

Contact rating gold: 0.4 VA @ 20 VDC or peak AC
 silver: 300 milliamp @ 125 VAC
 Electrical life. 15,000 cycles
 Mechanical life. 15,000 cycles
 Contact resistance, initial max 30 mOhm, 100 mOhm (after test)
 Insulation resistance. min 1,000 MOhm
 Dielectric strength 500 V for 1 min
 Actuation force. 6.0 N (600 gf) average
 Actuator travel 2.00 mm (.079) average

Environmental specification

Operating temperature -20 to +85°C
 Storage temperature -40 to +100°C
 Solder heat resistance. 265°C/10s wave

Material specifications

Contacts copper alloy silver or gold finish
 Actuator nylon 66
 Terminals copper alloy silver or tin finish
 Frame steel tin finish
 Terminal board phenolic
 RoHS Directive 2002/95/EC compliant

Product key	Typical product key		MSSA	2	4	50	G	04
Type	MSSA Slide switch, instrumentation grade							
No of poles	1 single pole	3 tripple pole						
	2 double pole	4 4 pole						
No of throws	3 3 throws	4 4 throws						
Actuator length	50 standard version							
Actuation	blank vertical	R right angle						
Contact finish	blank silver	G gold						
Material	04 RoHS compliant							

MSSA Series, Instrumentation Grade, THT (Continued)

Single pole



3 throws, vertical



MSSA1350

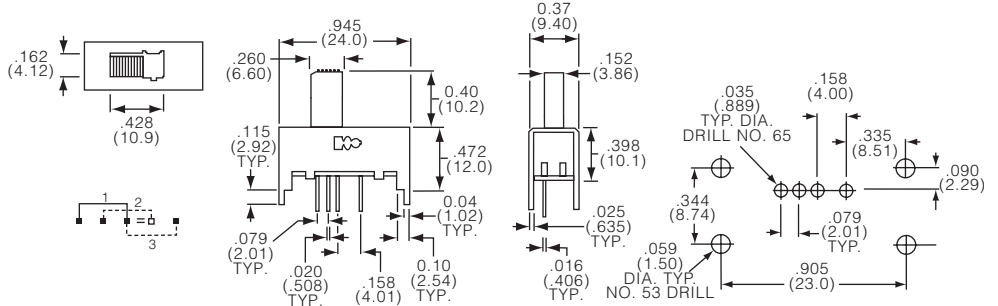

3 throws, right angle



MSSA1350R

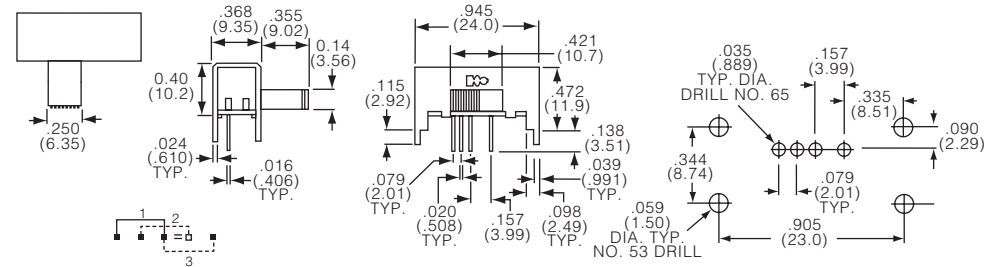

4 throws, vertical



MSSA1450

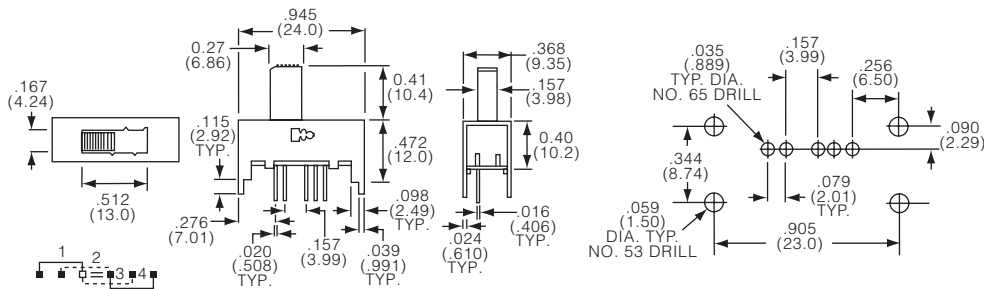

4 throws, right angle



MSSA1450R

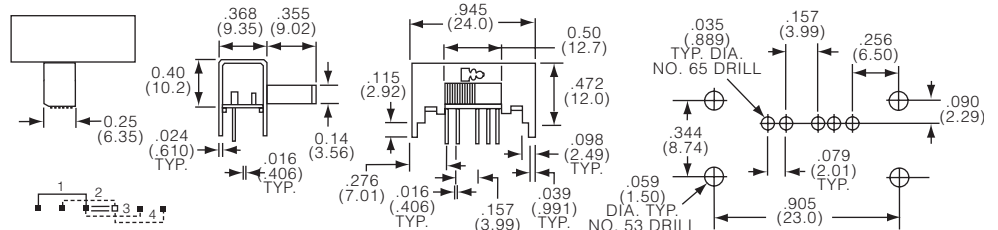

Slide Switches

MSSA Series, Instrumentation Grade, THT (Continued)

Double pole



3 throws, vertical



MSSA2350

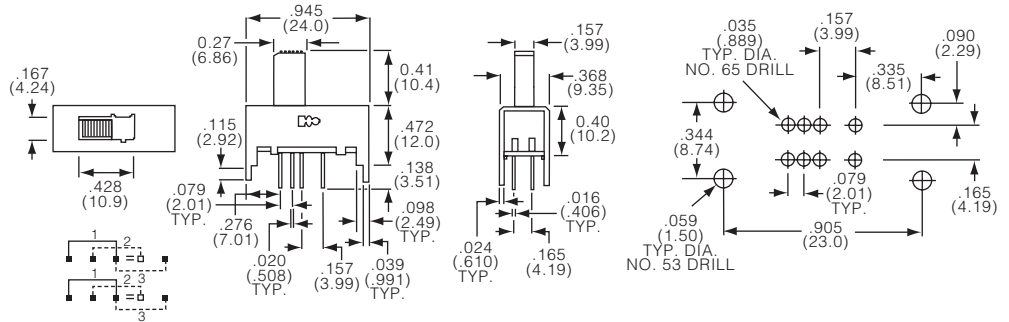

3 throws, right angle



MSSA2350R

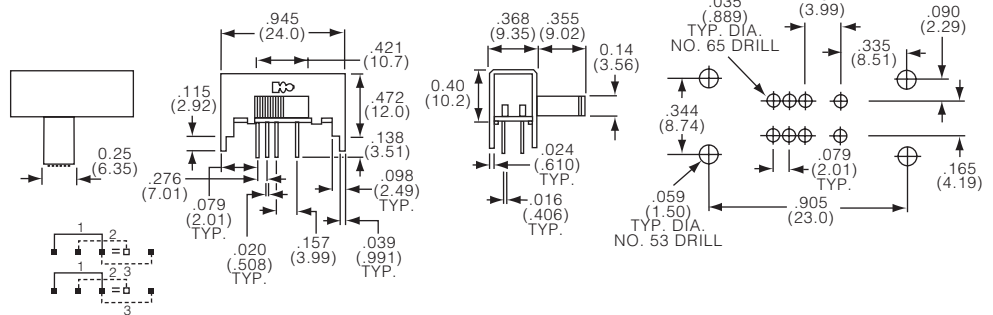

4 throws, vertical



MSSA2450

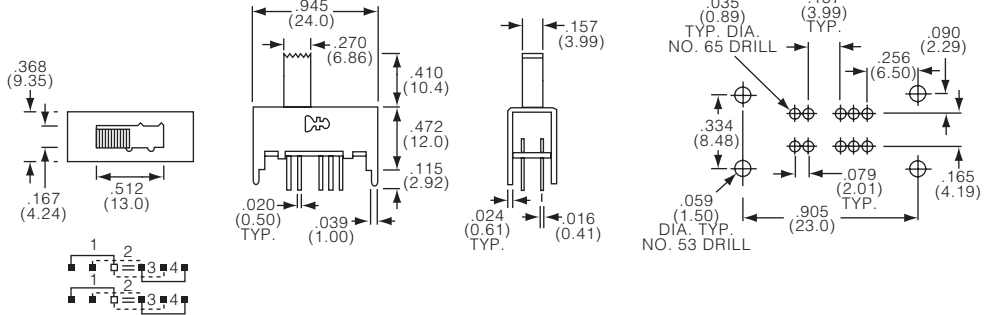

4 throws, right angle



MSSA2450R

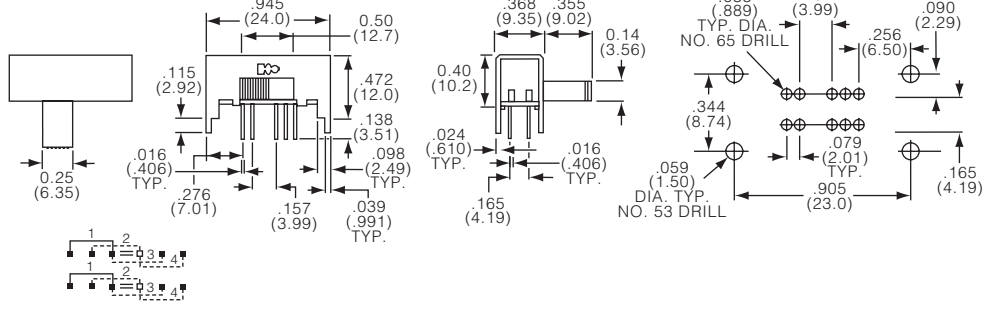

MSSA Series, Instrumentation Grade, THT (Continued)

3 pole



3 throws, vertical



MSSA3350

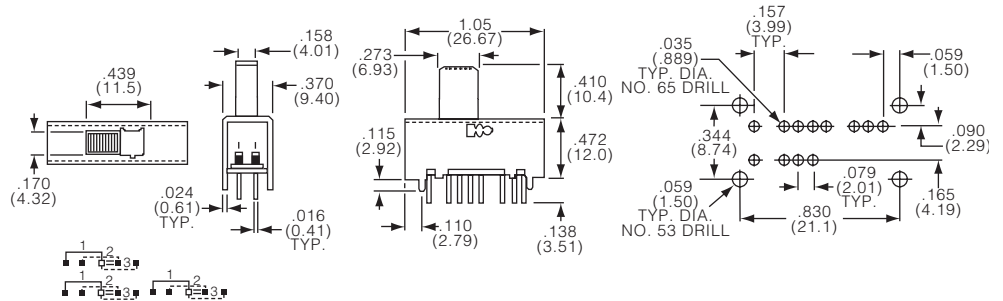

3 throws, right angle



MSSA3350R

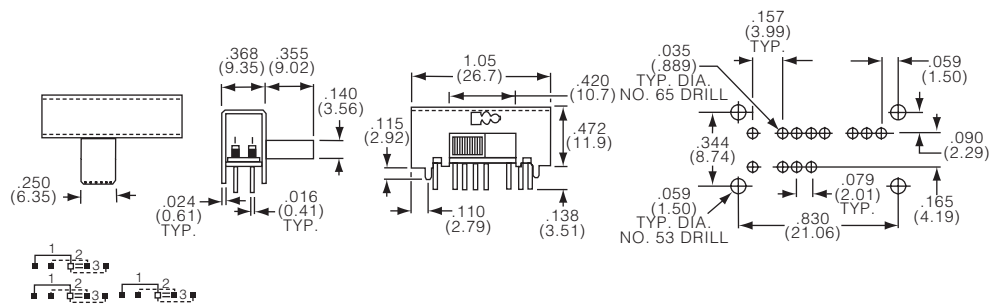

4 throws, vertical



MSSA3450

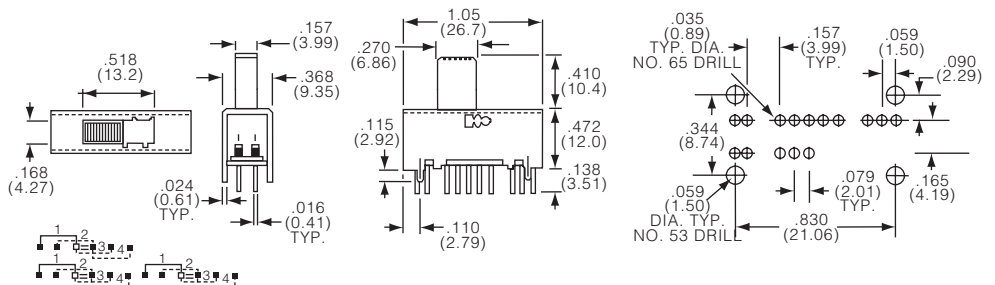

4 throws, right angle



MSSA3450R

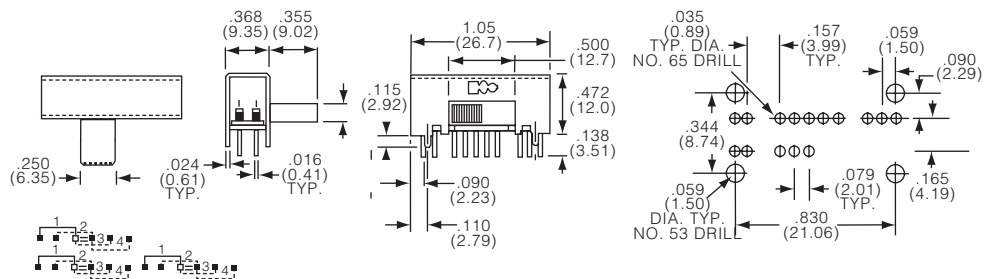

MSSA Series, Instrumentation Grade, THT (Continued)

4 pole



3 throws, vertical



MSSA4350

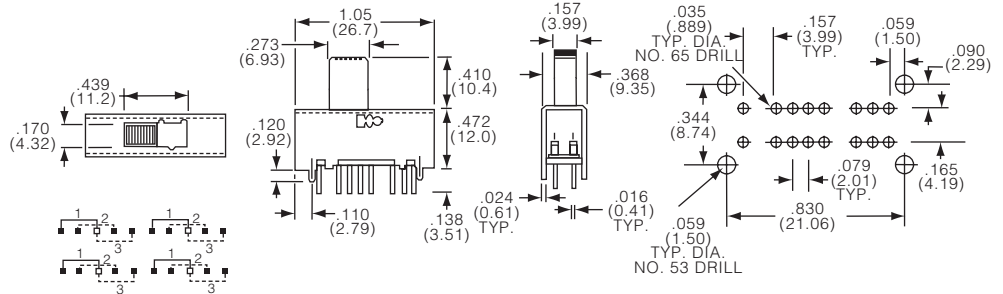

3 throws, right angle



MSSA4350R

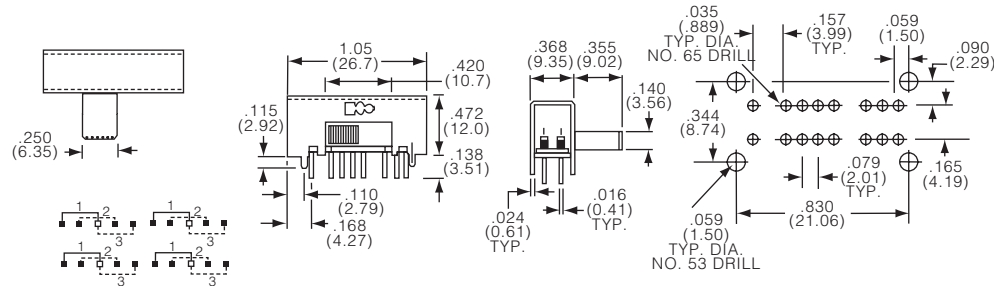

4 throws, vertical



MSSA4450

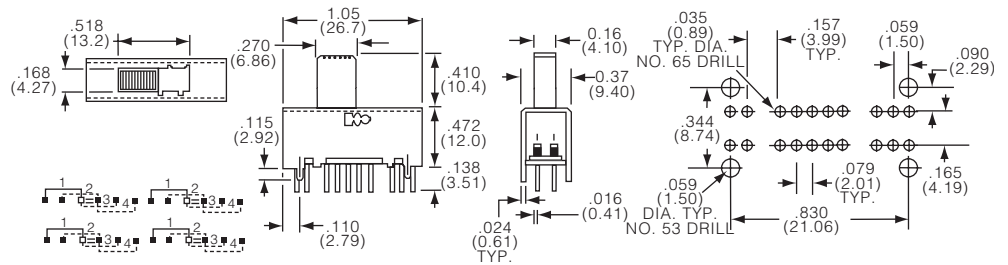

4 throws, right angle



MSSA4450R

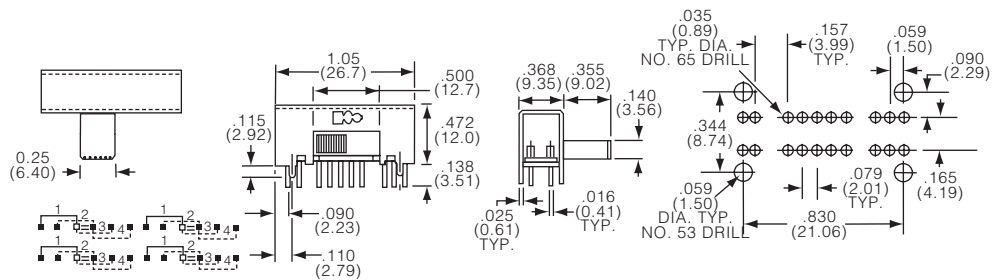

MSSA Series, Instrumentation Grade, THT (Continued)

Product key	No of poles	No of throws	Actuation	Contact finish	Material	Part Number
MSSA135004	single	3 throws	vertical	silver	RoHS	1825194-1
MSSA1350G04	pole			gold	compliant	1825194-2
MSSA1350R04			right angle	silver		1825195-1
MSSA1350RG04				gold		1825195-2
MSSA145004		4 throws	vertical	silver		1825196-1
MSSA1450G04				gold		1825196-2
MSSA1450R04			right angle	silver		1825197-1
MSSA1450RG04				gold		1825197-2
MSSA235004	double	3 throws	vertical	silver		1825198-1
MSSA2350G04	pole			gold		1825198-2
MSSA2350R04			right angle	silver		1825199-1
MSSA2350RG04				gold		1825199-2
MSSA245004		4 throws	vertical	silver		1825200-1
MSSA2450G04				gold		1825200-2
MSSA2450R04			right angle	silver		1825201-1
MSSA2450RG04				gold		1825201-2
MSSA335004	triple	3 throws	vertical	silver		1825202-1
MSSA3350G04	pole			gold		1825202-2
MSSA435004	4 pole			silver		1825202-3
MSSA4350G04				gold		1825202-4
MSSA3350R04	triple		right angle	silver		1825203-1
MSSA3350RG04	pole			gold		1825203-2
MSSA4350R04	4 pole			silver		1825203-3
MSSA4350RG04				gold		1825203-4
MSSA345004	triple	4 throws	vertical	silver		1825204-1
MSSA3450G04	pole			gold		1825204-2
MSSA445004	4 pole			silver		1825204-3
MSSA4450G04				gold		1825204-4
MSSA3450R04	triple		right angle	silver		1825205-1
MSSA3450RG04	pole			gold		1825205-2
MSSA4450R04	4 pole			silver		1825205-3
MSSA4450RG04				gold		1825205-4

SDS Series, Decorative Instrument Grade, THT

Slide Switches

Features

- High reliability contact system
- Robust actuator for easy actuation
- Make-before-Break timing



Typical performance characteristics

Contact rating 250 milliamps @125 VAC
 Electrical life 10.000 cycles
 Mechanical life 10.000 cycles
 Contact resistance, initial max 20 mOhm, 60 mOhm (after test)
 Insulation resistance min 500 MOhm
 Dielectric strength 500 VAC for 1 min
 Actuation force 1.0 to 7.0 N (100 to 700 gf)
 Actuator travel 2.0 (.079) average

Environmental specification

Operating temperature -10 to +60°C
 Storage temperature -10 to +60°C
 Solder heat resistance 265°C/10s wave

Material specifications

Contacts copper alloy silver finish
 Actuator pbt
 Terminals copper alloy silver finish
 Case steel zinc finish
 Terminal board phenolic
 RoHS Directive 2002/95/EC compliant

Product key		Typical product key		SDS	1	2	40	RA	0
Type	SDS	Slide switch, decorative instrument grade							
No of poles	1	single pole	2	double pole					
No of throws	2	two throws	3	three throws					
Version	40	standard version							
Terminal	RA	right angle							
Actuator color	0	black	8	gray					

SDS Series, Decorative Instrument Grade, THT (Continued)

Single pole



2 throws



SDS1240RA0

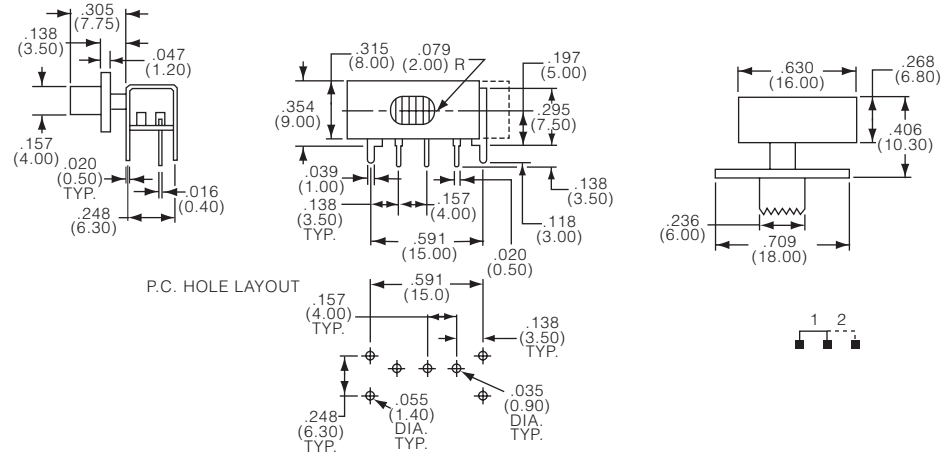

3 throws



SDS1340RA0

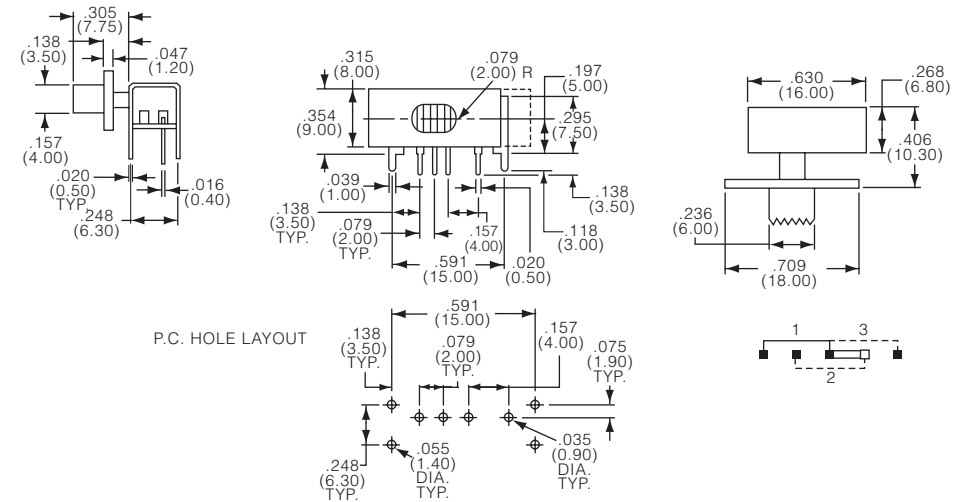

SDS Series, Decorative Instrument Grade, THT (Continued)

Slide Switches

Double pole



2 throws



SDS2240RA0

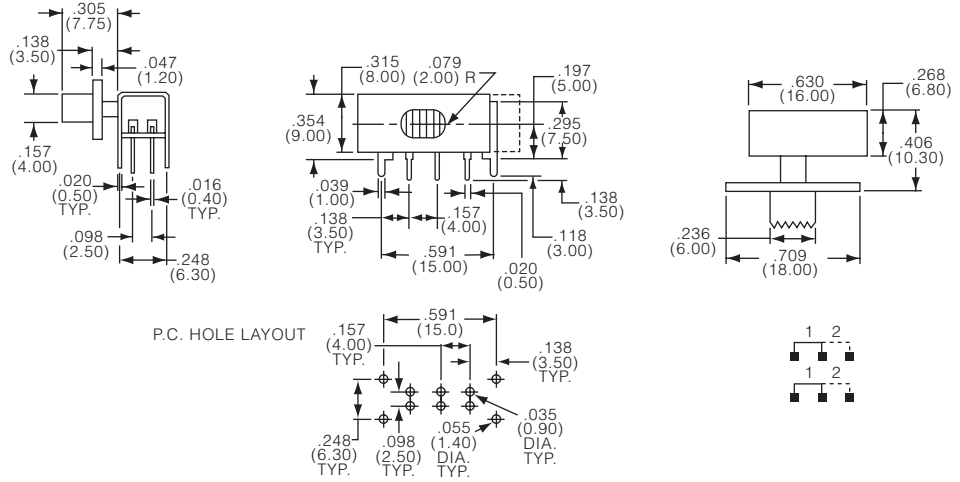

3 throws



SDS2340RA0

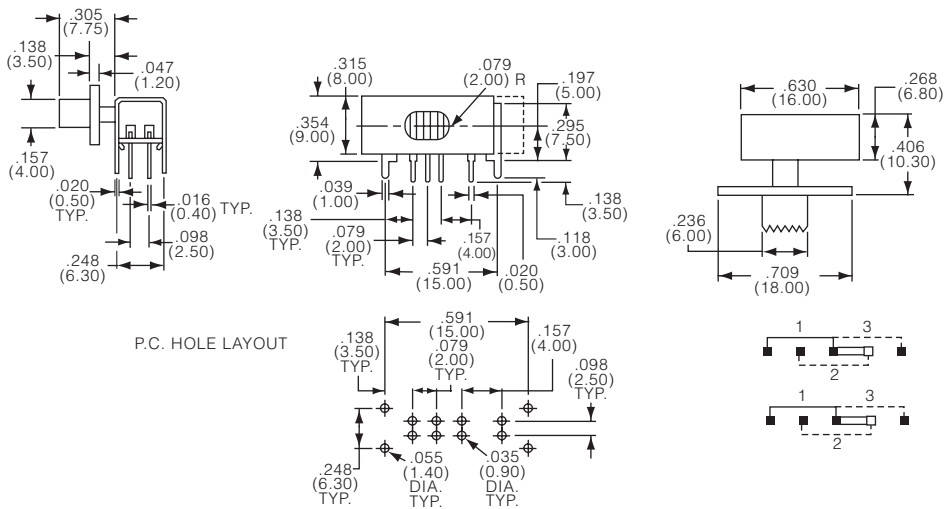

Product key	No of poles	No of throws	Terminal	Actuator color	Part Number
SDS1240RA0	single	2 throws	right angle	black	1437577-2
SDS1240RA8	single	2 throws	right angle	gray	1437577-3
SDS1340RA0	single	3 throws	right angle	black	1437577-4
SDS1340RA8	single	3 throws	right angle	gray	1437577-5
SDS2240RA0	double	2 throws	right angle	black	1437577-6
SDS2340RA0	double	3 throws	right angle	black	1437577-7

CST Series, Baton Toggle, Multiple Pole, THT (Continued)

2 poles

double throw



CST022NK

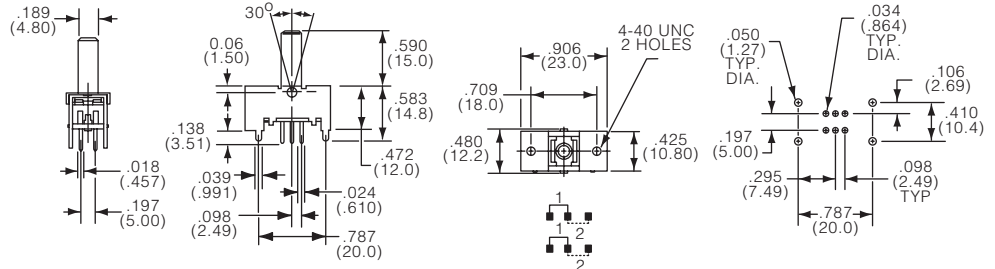

triple throw



CST023NK

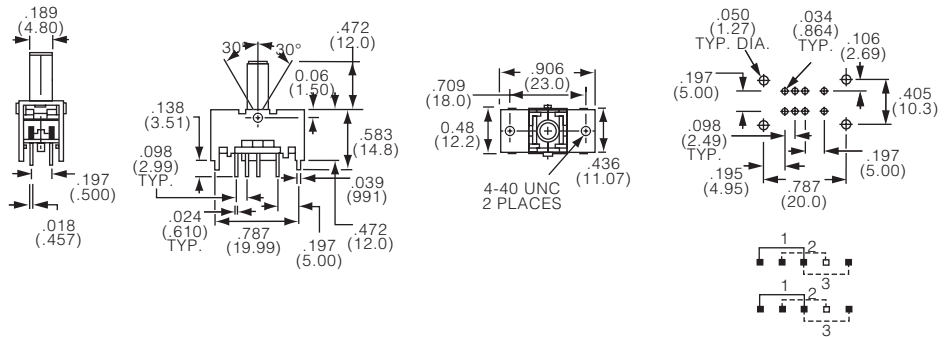

4 poles

double throw



CST042NK

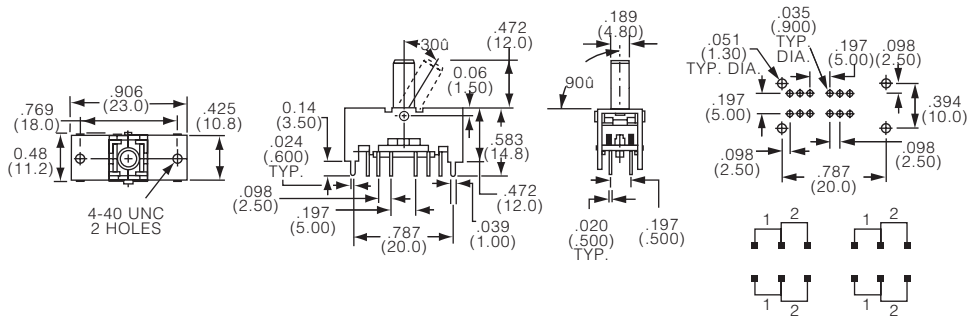

triple throw



CST043NK

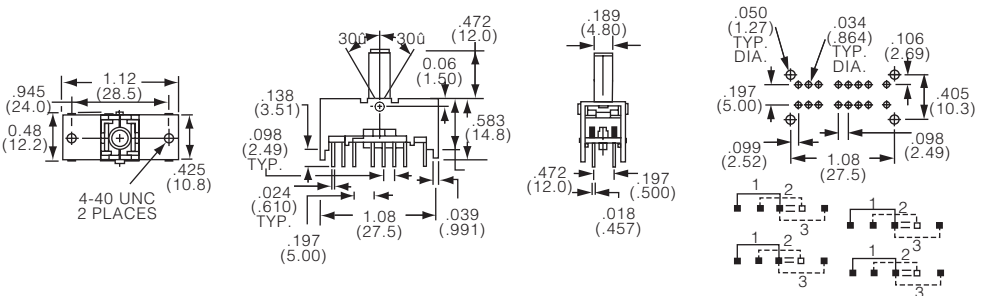

CST Series, Baton Toggle, Multiple Pole, THT (Continued)

6 poles 

double throw



CST062NK

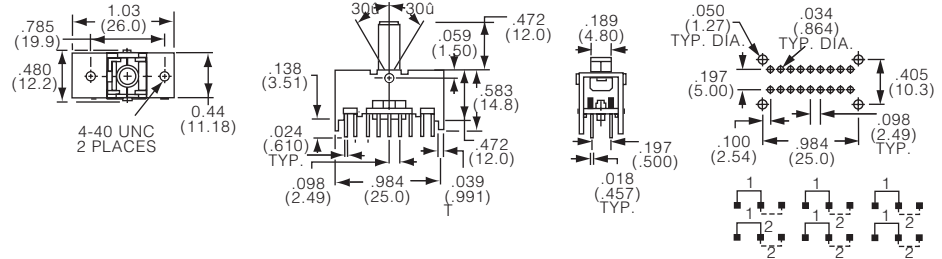

Slide Switches

Product key	No of poles	No of throws	Version	Part Number
CST022NK	2 poles	2 throws	standard	1437576-2
CST023NK		3 throws		1437576-4
CST042NK	4 poles	2 throws		1437576-5
CST043NK		3 throws		1437576-6
CST062NK	6 poles	2 throws		1437576-7

MLL Series, Micro Size, Low Profile, SMT

Features

- Low profile design
- Right angle mounting



Slide Switches

Typical performance characteristics

Contact rating 300 milliamps @ 4 VDC
 Electrical life 10,000 cycles
 Mechanical life 10,000 cycles
 Contact resistance, initial max 70 mOhm
 Insulation resistance min 100 MOhm
 Dielectric strength 100 VAC for 1 min
 Actuation force 1.75 +/-1.0 N (175 +/-100 gf)
 Actuator travel 1.50 mm (.059)

Environmental specification

Operating temperature -10 to +60°C
 Storage temperature -20 to +85°C
 Solder heat resistance 260°C/10s reflow

Material specifications

Contacts copper alloy silver finish
 Actuator nylon 46
 Terminals copper alloy silver finish
 Frame nickel Silver
 Case lcp
 RoHS Directive 2002/95/EC compliant

Product key

Typical product key

MLL 1 2 00 S

Type	MLL	Slide switch, low profile, right angle, SMT
No of poles	1	single pole
No of throws	2	2 throws
	3	3 throws
Version	00	standard
Terminals	S	surface mount SMT
Packaging	blank	bulk
	TR	tape & reel

MLL Series, Micro Size, Low Profile, SMT (Continued)

Single pole



2 throws



MLL1200S

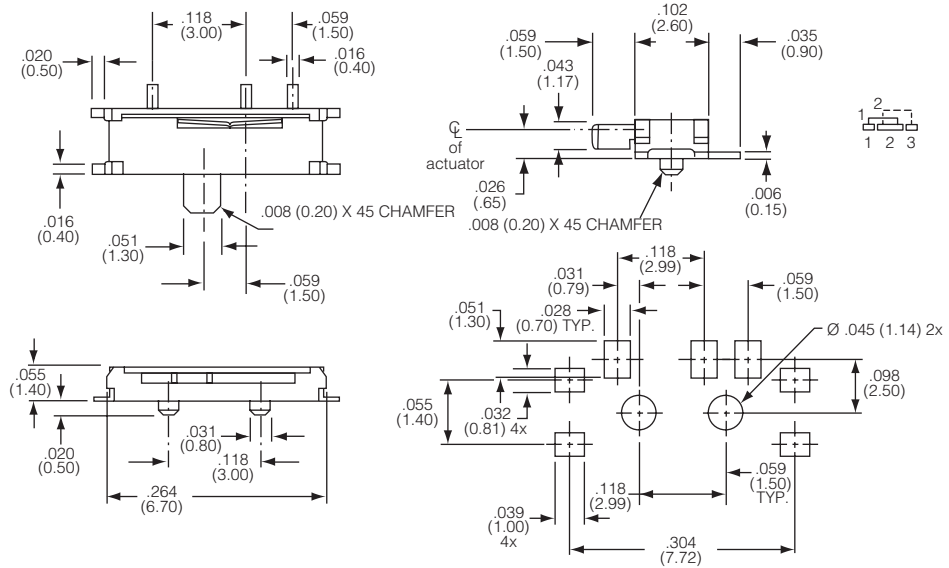

3 throws

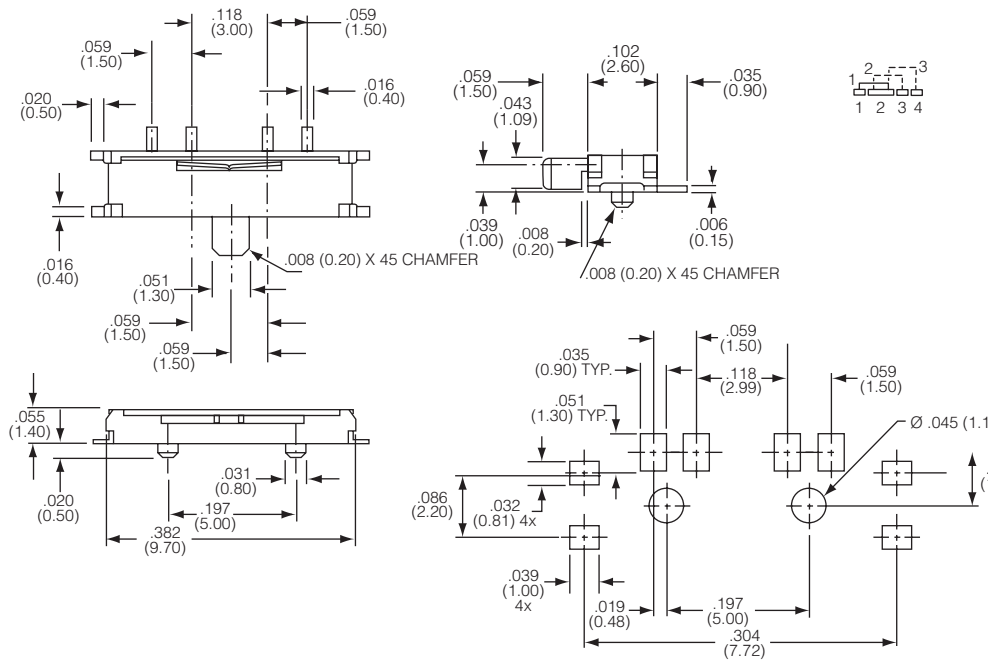

Product key	No of poles	No of throws	Terminals	Packaging	Part Number
MLL1200S	single	2 throws	surface mount	bulk	1437575-1
MLL1200STR	pole		SMT	tape & reel	1437575-2
MLL1300S		3 throws		bulk	1437575-3

Preferred parts in bold print

A68 Series, Instrumentation Grade, THT

Slide Switches

Features

- Approved construction
- Self-cleaning, gold sliding contact
- Break-before-Make timing



Typical performance characteristics

Contact rating 0,3 A @ 24 V AC/DC
 Electrical life > 500 cycles
 Mechanical life > 1,000 cycles
 Contact resistance max 80 mOhm
 Insulation resistance min. 1,000 MOhm
 Dielectric strength 500 VAC
 Actuator travel 2.0 mm

Environmental specification

Operating temperature -25°C to +85°C
 Storage temperature -25°C to +85°C
 Solder heat resistance 265°C/ 10s wave

Material specifications

Base psu
 Cover psu
 Contacts copper alloy gold finish
 Terminals copper alloy tin finish
 actuator pa
 RoHS compliance compliant

Actuator

Extended actuator



1 changeover contact

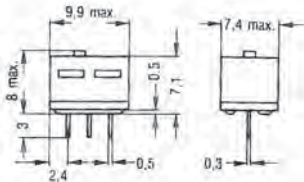

2 changeover contacts

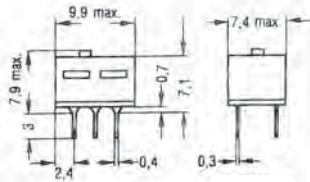

Adapter



1 changeover contact

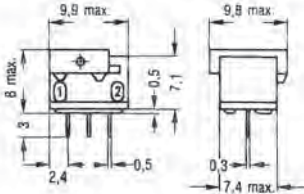

2 changeover contacts

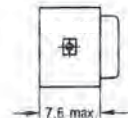
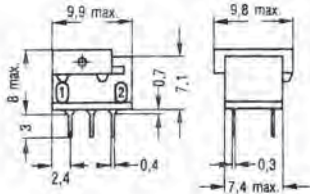

A68 Series, Instrumentation Grade, THT (Continued)

Flush actuator



1 changeover contact

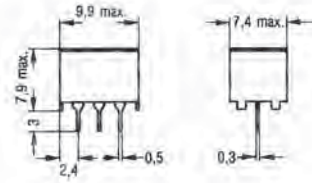

2 changeover contacts

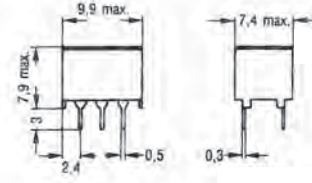

travel S = 2 mm

Function

1 changeover contact
switch position

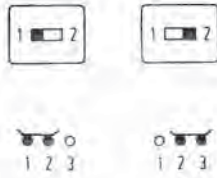

circuit diagram



2 changeover contacts
switch position

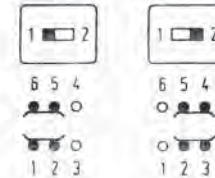

circuit diagram

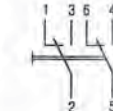

Mounting

1 changeover contact



dimension a = 2.5..2.54 mm

2 changeover contacts



Product key	No of poles	Actuator	Material	Part Number
C42315A68A1	2	extended	RoHS	1393685-1
C42315A68A2		adapter	compliant	1393685-2
C42315A68A3	1	extended		1393685-3
C42315A68A4		adapter		1393685-4
C42315A68A31	2	flush		1393685-5
C42315A68A33	1			1393685-7

X-ON Electronics

Largest Supplier of Electrical and Electronic Components

Click to view similar products for [Slide Switches](#) category:

Click to view products by [TE Connectivity](#) manufacturer:

Other Similar products are found below :

[6-1437581-1](#) [M43R](#) [MHSS1104A](#) [MMD](#) [GH36W010001](#) [GH49S010001](#) [1437576-8](#) [EPS1PC1](#) [1825074-1](#) [1825160-3](#) [1825167-2](#)
[25139NLDB](#) [25449NAH](#) [L101011ML04B](#) [SLB1240R45](#) [SLSA12004](#) [1825078-1](#) [1825080-4](#) [1825081-1](#) [1825269-1](#) [1825270-2](#)
[STS141RA04](#) [T2215BEN506](#) [GF-124-0204](#) [GH46P000001](#) [GH46W000001](#) [GH49P010001](#) [25339NA](#) [25436NLDH](#) [CST91246FK](#)
[TG36P000000](#) [TG36P000050](#) [47227LFE](#) [49331L](#) [MHSS1105A](#) [50208L](#) [L202091MS02Q](#) [4-1437581-7](#) [X2225CR-437W](#) [48BFSP3M2QT](#)
[49329L](#) [1101M1S3ZB8E2](#) [1-1437581-1](#) [EG1218REDACTUATOR](#) [TG39W000000](#) [1825075-1](#) [TG36WS80065](#) [T105S1CWZBE](#)
[SLB1280R5](#) [25136NLDB](#)