



Raychem Molded Parts

Visual Reference Guide

Seal, Protect, and Strain-Relieve
with Heat-Shrinkable Molded Parts in
a Range of Shapes and Materials to
Help Withstand Harsh Environments

Raychem Molded Parts

Visual Reference Guide

Contents

Introduction	3
• System Options	4
• Molded Parts Materials	7
• Adhesive/Sealant Product Characteristics	8
Part Numbering System	9
Visual Reference	10
• Boots	10
• Lipped Boots for Use with a Circular Connector Adapter	10
• Nonlipped Boots for Direct Attachment to Circular Connectors	11
• Slim-Line Boots	12
• Uniboosts	12
• Rectangular Boots	13
• Micromolded Boots	14
• Transitions	15
• Bulbous Transitions	15
• Slim-Line Transitions	17
• Covers	18
• Sleeves	19
• Caps	19
• Feedthroughs	19
• Miscellaneous Cable Management	19
• Selected Molded Shape Families	20
Boot Selection Tables	23
Raychem Application Tooling	27

With one of the largest varieties of heat-shrinkable molded parts available, the TE Connectivity (TE) Raychem brand offers both the components and system-level solutions for complete harnesses.

This visual guide provides photos of common configurations, both in their expanded and fully recovered forms. Because the photos do not indicate relative sizes, the individual product photos are followed by family shots to show the range of each family.

Heat-shrinkable molded parts are useful for a wide range of harnessing needs, including:

- **Connector sealing**
- **Cable strain relief**
- **Cable breakouts and transitions**
- **End caps**

TE Components . . . TE Technology . . . TE Know-how . . .

AMP | AGASTAT | CII | HARTMAN | KILOVAC | MICRODOT | NANONICS | POLAMCO | Raychem | Rochester | DEUTSCH
SEACON Phoenix | LL ROWE | Phoenix Optix | AFP | SEACON

Get your product to market faster with a smarter, better solution.



HAZARD MATCHED

- Different families meet a wide range of challenging environments
- Custom material formulation for enhanced performance

SYSTEM MATCHED

- Molded parts, adhesives, tubing, and cable insulations and jackets— all designed to work together

VERSATILE

- Wide range of shapes and sizes
- Custom features available
- With or without pre-applied adhesive

HIGH PERFORMANCE

- High dielectric strength
- Mechanical robustness
- Superior chemical and fluid resistance
- Wide temperature ranges
- Excellent sealing

Molding Expertise in Materials to Work for You

Expertise in crosslinked polymer chemistry allows TE to create unique formulations that go beyond off-the-shelf polymers to provide exceptional performance in heat-shrinkable tubing, molded parts, and wire insulation and jackets.

Crosslinking and specialized chemical formulations combine to provide demanding markets with reliable high-temperature and fluid-resistant products. Not only did TE's Raychem business pioneer crosslinking and invent heat-shrinkable tubing, we have continually innovated the technology, evolving it into new materials, new applications, and new levels of performance and quality.

Matched to Your Application Needs

TE's Raychem heat-shrinkable molded parts meet a wide range of harsh environmental conditions. Mechanically robust molded parts are easy to install and available in a variety of sizes and shapes.

We have leveraged our expertise in materials well suited to applications requiring:

- Low and high-temperature environments
- Fluid resistance
- Flame resistance
- Mechanical abuse
- Environmental sealing
- Strain relief
- Transitions





A System-Level Approach to Harnessing

Engineered component systems of matched performance is the key to simplifying product choice for a variety of markets. From commercial applications to high-end demands in the aerospace industry, TE has a variety of material systems designed to survive the temperature and harsh environments required by the various markets.

Systems

Components	System 10	System 20	System 25	System 30	System 100	System 200	System 300
Tubing	VERSAFIT	NTFR	DR-25	VPB	ZHTM	RW-200	RT555
Molded Part	-3,-4,-71	-51	-25, -25L	-50	-100	-12	-55
Adhesive	S1017, S1030	S1124, S1048	S1048, S1125	S1125, S1255-04	S1030, S1125	S1125, S1255-04	S1255-04
Precoat	/42, /180	/164, /86	/86, /225	—	/180	—	—



INSTALITE Lightweight Molded Parts

INSTALITE boots are a lighter weight alternative of our -25 heat-shrink boots. Using our expertise in fluid-resistant, modified elastomers, we've created semi-rigid, abrasion-resistant boots that are up to 30% lighter than our standard -25 boots. INSTALITE boots offer the same balance of high-temperature fluid resistance and long-term heat resistance.



Shaped to Your Needs

Also available is an extensive line of adapters and heat-shrinkable tubing to further integrate and strengthen harness assemblies.

Whatever your application, our molded parts almost always meet the performance characteristics you require.



BULBOUS SHAPES

Raychem bulbous-shaped molded parts are VG approved and help provide rugged mechanical and environmental protection, meet numerous specifications, and have been used successfully in military wire and cable harnesses for more than 30 years.

Most connector strain relief boots come in two versions:

- **Lipped** A molded adapter lip locks into the groove on the backshell adapter. Lipped part numbers are identified with a "D" or "K."
- **Nonlipped** The boot may be installed directly on the rear of connector threads 12 mm or longer. Nonlipped part numbers are identified with an "A."

Many other optional features are available, such as molded ports and drain holes. For other modifications and custom shapes, please contact TE.



MODIFICATIONS

Certain variations of the standard shapes, such as shorter leg lengths or specific overexpansions, are possible. Modifications must be requested prior to your order to determine feasibility.

SPECIALS

Complete design, tooling, and production of custom molded shapes and special adaptations are also possible. Estimates are made upon request.



HEAVY-DUTY CABLE BREAKOUTS

Heavy-duty breakouts provide mechanical strain relief and environmental sealing for power cables where the cable jacket is cut back and conductors broken out.

These boots are used widely in ship building and meet the requirements of the following:

- Lloyd's Register of Shipping
- Det Norske Veritas (DNV)
- American Bureau of Shipping (ABS)
- DOD-STD-2003
- MIL-I-81765/1A
- AS85049/142

SLIM-LINE SHAPES

With their low profile, these flexible shapes conform to cables better and create less bulk at transition points and connectors than bulbous shapes. Slim-line shapes include straight and right-angle boots as well as transitions. A small family of parts can provide a wide variety of expansions (under expansion, over expansion, cutoff).

MICROMOLDED SHAPES

With the continued miniaturization of electronic systems and connectors, our micromolded parts offer weight and size savings—and compatibility with today's miniature parts.

CABLE END CAPS

Heat-shrinkable end caps provide a reliable method of sealing power cables, pipes, conduit, and other cylindrical objects to help protect against corrosion and moisture penetration.

Rayaten EMI SHIELDED BOOTS

The Rayaten screen termination is a range of heat-shrinkable boots, transitions, and conductive adhesives that provide high levels of screening against electromagnetic radiation across a very wide frequency range.





Material ID	Material	Temperature Range	Shelf Life	TE Raychem Specification
Ruggedized Materials				
-3	Flame-retardant, semi-rigid polyolefin	-55°C to +135°C	5 years	RT-301
-4	Flame-retardant, flexible polyolefin	-55°C to +135°C	5 years	RT-1304
-12	Flexible, chemical-resistant fluoroelastomer	-55°C to +200°C	3 years	RT-1312
-25	Fluid resistant modified, semi-rigid elastomer	-75°C to +150°C	5 years	RW-2070
-25L	Light weight, flame-retardant, semi-rigid, elastomer	-75°C to 150°C	5 years	RW-3040
-71	Semi-rigid modified polyolefin	-55°C to 135°C	5 years	RT-1316
-100	Zerohal low-fire-hazard material	-30°C to +105°C	5 years	RW-2082
Slim-Line Materials				
-50	Fluid-resistant modified elastomer	-55°C to +150°C	15 months	RT-1313
-51	Chemical-resistant fluoroelastomer	-55°C to +135°C	15 months	RT-1321
-55	Flexible fluoropolymer	-65°C to +200°C	Unlimited	RT-1330
Chemical, Biological, Radiation, Nuclear-Resistant Materials				
-770	CBRN fluoropolymer	-55°C to +125°C	3 years	RT-770 Type II
-780	CBRN fluoropolymer	-55°C to +175°C	5 years	RT-780 Type II
-790	CBRN fluoropolymer	-55°C to +200°C	5 years	RT-790 Type II





Adhesive/Sealant Product Characteristics Tables

Product Type	Precoat Designation	Type	Operating Temperature Range	Product Designation	Available Form/Packaging
Thermosets					
S1006		Epoxy/polyamide two-part paste	-55°C to 135°C [-67°F to 275°F]	S1006 Kit 1	Two 15-gram packs
				S1006 Kit 2	Four 7.5-gram packs
				S1006 Kit A	Ten 3-gram packs
S1009	—	Epoxy/polymercaptan two-part paste	-55°C to 135°C [-67°F to 275°F]	S1009 Kit A	Ten 3-gram packs
				S1009 Kit 8	50-ml dual syringe
S1255-04	—	One-part epoxy tape adhesive	-55°C to 200°C [-67°F to 392°F]	S1255-04	Tape [3/4 in. x .020 x 100 ft.]
S1125	—	Epoxy/polyamide two-part paste	-55°C to 150°C [-67°F to 302°F]	S1125 Kit 1	Five 10-gram packs
				S1125 Kit 2	Two 10-gram packs
				S1125 Kit 4	Five 10-gram packs
				S1125 Kit 5	One 10-gram pack
				S1125 Kit 8	50-ml dual syringe
S1264	—	Epoxy/polyamide two-part paste	-55°C to 150°C [-67°F to 302°F]	S1264 Kit 1	One 10-gram pack
				S1264 Kit 8	50-ml dual syringe
	/225	Precoated latent-curing epoxy/polyamide	-75°C to 150°C [-103°F to 302°F]	Precoat only on -25 molded parts	—
Thermoplastics					
S1017	/42	Hot-melt, polyamide	-20°C to 60°C * [-4°F to 140°F]	S1017	Tape [1 in. x .010 in. x 50 ft.]
S1030	/180	Hot-melt, polyolefin	-80°C to 80°C [-112°F to 176°F]	S1030	Tape [3/4 in. x .010 in. x 33 ft.]
S1048	/86	Hot-melt, high performance	-55°C to 120°C [-67°F to 248°F]	S1048	Tape [1 in. x .026 in. x 100 ft.]
S1124	/164	Hot-melt, elastomeric polymer	-55°C to 105°C [-67°F to 221°F]	S1124	Tape [3/4 in. x .018 in. x 10 ft.]
S1297	/97	Hot-melt, polyamide adhesive	-20°C to 90°C [-4°F to 194°F]	S1297	Tape [1 in. x .010 in. x 10 ft.]
Sealants					
S1278	—	Hot-melt grey butyl sealant	-40°C to 90°C [-40°F to 194°F]	S1278-01	Tape [1 in. x .062 in. x 25 ft.]
				S1278-02	Tape [3-3/4 in. x .125 in. x 10 ft.]
S1305	—	Hot-melt grey butyl sealant, FR	-40°C to 90°C [-40°F to 194°F]	S1305-01	Tape [1 in. x .062 in. x 25 ft.]

*Passes cold bend at -40°C [-40°F] per RT-4204.

For full details on installation procedures and curing conditions, please refer to the applicable TE Code of Practice or installation document.



Part Numbering System

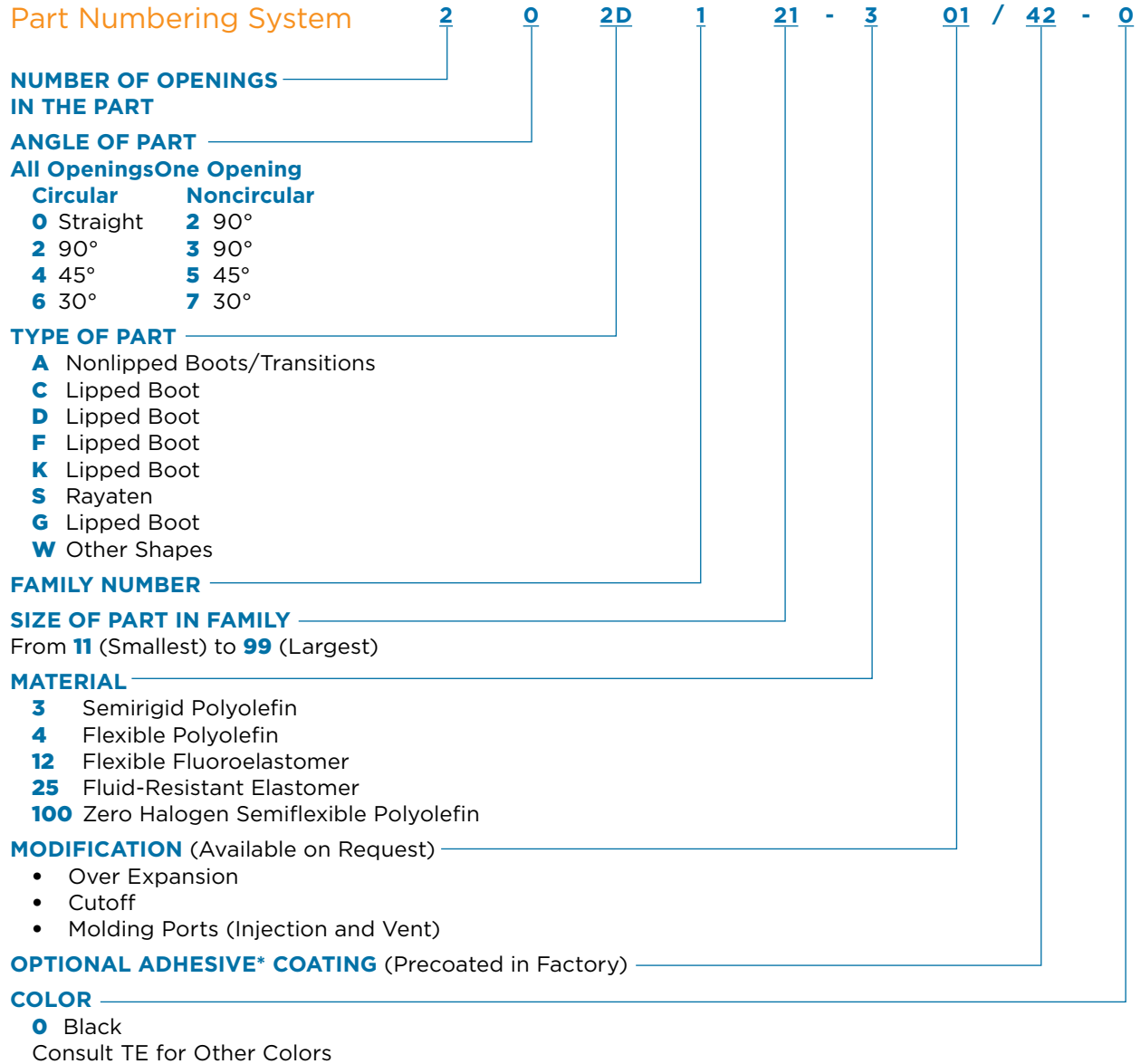



Visual Reference

Lipped Boots
For Use with Adapters

As Supplied	Recovered	Part No.	As Supplied	Recovered	Part No.
		202D121 through 202D196			202D211 through 202D299
		202D921 through 202D963			202K121 through 202K185
		222B012 through 222B063			222B112 and 222B123
		222D121 through 222D196			222D211 through 222D299
		222D921 through 222D963			222K121 through 222K185
		242A312 and 242A322			







































Available in INSTALITE -25L Material
Many of the shapes shown above are available as INSTALITE lightweight boots. Consult TE.



Visual Reference

Nonlipped Boots

For Direct Attachment on Connectors

As Supplied	Recovered	Part No.	As Supplied	Recovered	Part No.
		202A011 through 202A096			203A211
		202A111 through 202A196			203A312
		202A212 through 202A264			204A011
		202A312 through 202A364			204A311
		202A512			204A411
		202A915			204A511
		202A921			204A612
		202B422 and 202B433			208A011 through 208A098
		203A021			222A011 through 222A096*























*Shown with risers for potting









Visual Reference

Nonlipped Boots

For Direct Attachment on Connectors (continued)



As Supplied	Recovered	Part No.	As Supplied	Recovered	Part No.
		222A111 through 222A196*			226A045 and 226A075
		222A213 through 222A255			228A011 through 228A097
		222A313 through 222A355			242A142
		223A213 through 223A233			243A012 and 243A022
		224A012			246A166
*Shown with risers for potting					202B521 through 202B598

Slim-Line Boots

As Supplied	Recovered	Part No.
		202E334 through 202E346
		202F211 through 202F274 202G211 through 202G253
		222F211 through 222F285

Uniboosts

Allow a Variety of Cable Exit Angles

As Supplied	Recovered	Part No.
		202C611 through 202C663 202G621 through 202G653



Visual Reference

Rectangular Boots
For Rectangular Connectors

As Supplied	Recovered	Part No.	As Supplied	Recovered	Part No.
		211A012			214B713
		214A011 through 214A052			234A011 through 234A071
		214A124 and 214A133			234A111 through 234A152
		214A311 through 214A352			234A313 through 234A333
		214A452			234A413 through 234A434
		214A511 through 214A552			234A611 through 234A671
		214A613			234A711 through 234A752
		214A814			234A911 through 234A971
		214A923			234B011 through 234B052
		214B623			453A215 and 453A225
		413A013 through 413A024			



Visual Reference

Micromolded Boots

As Supplied	Recovered	Part No.	As Supplied	Recovered	Part No.
		202A111-25-G07-0			202K111-25-01-0
		203W301-25-G02-0			224W201-25-0
		224W221-25-0			204W221-25-0
		222A511-3-0			204W201-25-0
		223W601-25-0			302A115
		203W301-25-0			





Visual Reference

Bulbous Transitions

As Supplied	Recovered	Part No.	As Supplied	Recovered	Part No.
		301A011 through 301A048			322B813
		302A012 through 302A037			341A015
		302A214			342A012 through 342A058
		322A012 through 322A037			342A112 through 342A138
		322A112 through 322A158			342A215
		322A315			342A313 and 342A323
		322A412 through 322A434			343A014 through 343A027
		322A514			362A014 through 362A114



Visual Reference













Bulbous Transitions (continued)

As Supplied	Recovered	Part No.	As Supplied	Recovered	Part No.
		363A018 and 363A020			422A716
		381A015			422A813
		381A115			423A014
		382A012 through 382A046			423A117
		402A013			453A017
		403A123 through 403A155			462A011 through 462A060
		422A011			462A214
		422A114			502A812 through 502A845
		422A414			522A013
		422A616			561A017







Visual Reference





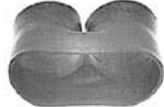

Bulbous Transitions (continued)

As Supplied	Recovered	Part No.	As Supplied	Recovered	Part No.
		622A014			602A022
		562A011 through 562A067			602A114
		602A012			602A212

Lipped Bulbous Transitions

As Supplied	Recovered	Part No.
		323A211
		323A222

Slim-Line Transitions

As Supplied	Recovered	Part No.
		301A511 through 301A514
		381A301 through 381A304
		462A421 through 462A424



Visual Reference

Covers

As Supplied	Recovered	Part No.	As Supplied	Recovered	Part No.
		102A911			220A012 through 220A023
		102A951			234A211
		102A961			234B111 and 234B122
		102A962			301A212, 301A222, 302A312
		102A981			302A734
		102A992			401A212 and 403A312
		102A993			401A414
		102A994			403A016
		202A817			501A012 and 502A212
		601A012			



Visual Reference

Sleeves

As Supplied	Recovered	Part No.
		200A413 and 200A426
		200D944 through 200D988

As Supplied	Recovered	Part No.
		202B811 through 202B821

Caps

As Supplied	Recovered	Part No.
		101A011 through 101A094
		102A811 through 102A865
		SSC

Feedthroughs

As Supplied	Recovered	Part No.
		207W213 through 207W264 with A-type nut
		207W213-x-01 through 207W264-x-01 with B-type nut
		Cable Entry Seals

Cable Management

As Supplied	Recovered	Part No.
		210W321 203W302 203W312 203W342

As Supplied	Recovered	Part No.
		400W242



Visual Reference

Selected Molded Shape Families



Lipped Boots (K Series)
202K121 through 202K185
VG Approved



Nonlipped Boots (A Series)
202A111 through 202A196



Nonlipped Boots (A Series)
202A212 through 202A264



Visual Reference

Selected Molded Shape Families

As Supplied



Recovered



Lipped Boots (D Series)
202D121 through 202D196

As Supplied



Recovered



Lipped Boots (D Series)
202D211 through 202D299
Mil Spec



Lipped Boots (D Series)
202D921 through 202D963
Mil Spec

As Supplied



Recovered



Feedthroughs
207W213 through 207W264



Rectangular Boots
214A011 through 214A052



Visual Reference

Selected Molded Shape Families

As Supplied



Recovered



90° Nonlipped Boots
222A111 through 222A196



90° Nonlipped Boots
222A213 through 222A255

As Supplied



Recovered



90° Nonlipped Boots
222A313 through 222A355

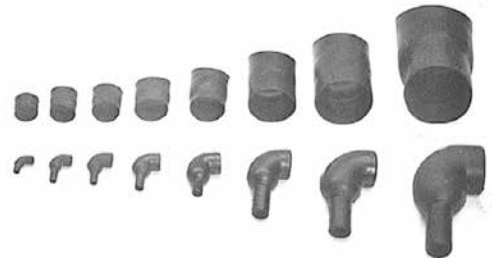

90° Lipped Boots
222D121 through 222D196

As Supplied



Recovered



90° Lipped Boots
222D211 through 222D299
Mil Spec



90° Lipped Boots
222D921 through 222D963
Mil Spec

As Supplied



Recovered



90° Lipped Boots
222K121 through 222K185
VG Approved

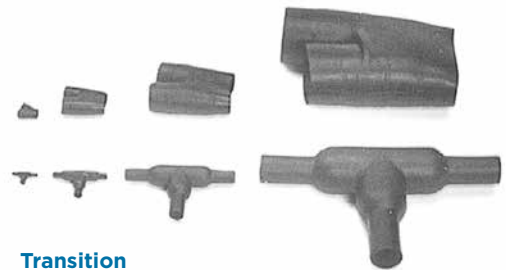

Transition
301A011 through 301A048



Boot Selection Tables

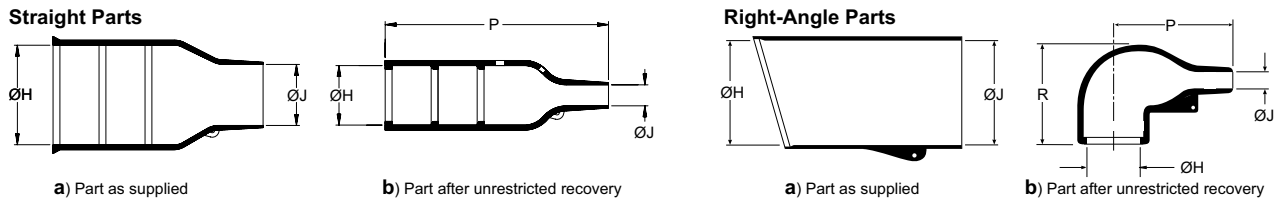

Dimensions relate to -3, -4, -25 compounds, unless otherwise noted.
For expanded dimensions of -12 and -100 parts, please refer to latest TE drawing on TE.com

Lipped Molded Parts

202K Bulbous Straight Parts: VG Style

Part No.	H		J		P ±10%
	Min.	Max.	Min.	Max.	b
	a	b	a	b	
202K121	24 [0.95]	10.4 [0.41]	24 [0.95]	5.6 [0.22]	38 [1.50]
202K132	30 [1.18]	14.2 [0.56]	30 [1.18]	5.9 [0.23]	55 [2.17]
202K142	31 [1.22]	18.0 [0.71]	31 [1.22]	7.1 [0.28]	67 [2.64]
202K153	36 [1.42]	22.4 [0.88]	36 [1.42]	8.4 [0.33]	80 [3.15]
202K163	43 [1.69]	28.2 [1.11]	43 [1.69]	9.9 [0.39]	99 [3.90]
202K174	60 [2.36]	35.1 [1.38]	60 [2.36]	15.7 [0.62]	130 [5.12]
202K185	66 [2.60]	44.5 [1.75]	66 [2.60]	16.8 [0.66]	170 [6.69]

222K Bulbous Right-Angle Parts: VG Style

Part No.	H		J		P ±10%	R ±10%
	Min.	Max.	Min.	Max.	b	b
	a	b	a	b		
222K121	24 [0.95]	10.4 [0.41]	24 [0.95]	5.6 [0.22]	25 [0.98]	25 [0.98]
222K132	30 [1.18]	14.2 [0.56]	30 [1.18]	5.9 [0.23]	32 [1.26]	27 [1.06]
222K142	31 [1.22]	18.0 [0.71]	31 [1.22]	7.1 [0.28]	39 [1.54]	31 [1.22]
222K153	36 [1.42]	22.4 [0.88]	36 [1.42]	8.4 [0.33]	46 [1.81]	38 [1.50]
222K163	43 [1.69]	28.2 [1.11]	43 [1.69]	9.9 [0.39]	55 [2.17]	45 [1.77]
222K174	60 [2.36]	35.1 [1.38]	60 [2.36]	15.7 [0.62]	80 [3.15]	54 [2.13]
222K185	66 [2.60]	44.5 [1.75]	66 [2.60]	16.8 [0.66]	108 [4.25]	68 [2.68]

Nonlipped Molded Parts

202A Straight Parts

Part No.	H		J		P ±10%
	Min.	Max.	Min.	Max.	b
	a	b	a	b	
202A011	10.7 [0.42]	7.9 [0.31]	8.4 [0.33]	3.8 [0.15]	25.4 [1.00]
202A021	23.7 [0.54]	9.9 [0.39]	11.7 [0.46]	5.3 [0.21]	38.1 [1.50]
202A032	19.3 [0.76]	14.2 [0.56]	14.2 [0.56]	6.6 [0.26]	51.3 [2.02]
202A042	23.9 [0.94]	17.8 [0.70]	15.5 [0.61]	7.4 [0.29]	66.8 [2.63]
202A053	30.0 [1.18]	21.9 [0.86]	18.0 [0.71]	8.6 [0.34]	73.7 [2.90]
202A063	37.8 [1.49]	27.4 [1.08]	21.3 [0.84]	9.4 [0.37]	99.1 [3.90]
202A074	47.0 [1.85]	35.3 [1.39]	35.6 [1.40]	16.0 [0.63]	130.3 [5.13]
202A085	59.4 [2.34]	43.7 [1.72]	43.7 [1.72]	19.6 [0.77]	161.3 [6.35]
202A096	81.3 [3.20]	57.2 [2.25]	55.6 [2.19]	26.9 [1.06]	212.6 [8.37]



Nonlipped Molded Parts (continued)

222A Right-Angle Parts

Part No.	H		J		P ±10%	R ±10%
	Min.	Max.	Min.	Max.		
	a	b	a	b		
222A011	10.7 [0.42]	7.9 [0.31]	8.4 [0.33]	3.8 [0.15]	17.3 [0.68]	20.1 [0.79]
222A021	13.7 [0.54]	10.4 [0.41]	11.7 [0.46]	5.6 [0.22]	21.3 [0.84]	22.6 [0.89]
222A032	19.3 [0.76]	14.2 [0.56]	14.2 [0.56]	6.6 [0.26]	26.9 [1.08]	24.1 [0.85]
222A042	23.9 [0.94]	17.8 [0.70]	15.5 [0.61]	7.1 [0.28]	36.6 [1.44]	30.5 [1.20]
222A052	30.0 [1.18]	22.4 [0.88]	18.0 [0.71]	8.4 [0.33]	43.7 [1.72]	34.1 [1.38]
222A063	37.8 [1.49]	28.2 [1.11]	21.3 [0.84]	9.9 [0.39]	53.6 [2.11]	43.9 [1.73]
222A074	47.0 [1.47]	35.1 [1.38]	35.6 [1.40]	15.7 [0.62]	78.0 [3.07]	52.8 [2.08]
222A085	59.4 [2.34]	44.5 [1.75]	43.7 [1.72]	20.3 [0.80]	97.5 [3.84]	66.0 [2.60]
222A096	81.3 [3.20]	57.2 [2.35]	55.6 [2.19]	26.7 [1.05]	128.0 [5.04]	79.2 [3.12]

Lipped, Low-Profile Boots

202D2 Straight Boots: Mil Spec Variants

Part No.	H		J		P ±10%
	Min.	Max.	Min.	Max.	
	a	b	a	b	
202D211	22.4 [.88]	11.4 [.45]	22.4 [.88]	6.4 [.25]	105.9 [4.17]
202D221	25.7 [1.01]	15.0 [.59]	25.7 [1.01]	7.4 [.29]	121.2 [4.77]
202D232	29.5 [1.16]	18.8 [.74]	29.5 [1.16]	8.4 [.33]	138.7 [5.46]
202D242	34.0 [1.34]	22.9 [.90]	34.0 [1.34]	9.7 [.38]	159.5 [6.28]
202D253	37.3 [1.47]	29.5 [1.16]	37.3 [1.47]	10.4 [.41]	177.8 [7.00]
202D263	43.7 [1.72]	34.0 [1.34]	43.7 [1.72]	12.2 [.48]	203.2 [8.00]
202D274	50.0 [1.97]	41.2 [1.62]	50.0 [1.97]	14.2 [.56]	203.2 [8.00]
202D285	62.7 [2.47]	47.0 [1.85]	62.7 [2.47]	17.5 [.69]	203.2 [8.00]
202D296	69.3 [2.73]	59.7 [2.35]	69.3 [2.73]	19.6 [.77]	203.2 [8.00]
202D299	81.8 [3.22]	67.1 [2.64]	81.8 [3.22]	22.9 [.90]	203.2 [8.00]

222D2 Right Angle Boots: Mil Spec Variants

Part No.	H		J		P ±10%	R Ref.
	Min.	Max.	Min. -3, -4, -25	Max.		
	a	b	a	b		
222D211	22.4 [.88]	11.4 [.45]	22.4 [.88]	6.4 [.25]	105.2 [4.14]	18.5 [.73]
222D221	25.7 [1.01]	15.0 [.59]	25.7 [1.01]	7.4 [.29]	124.0 [4.88]	19.8 [.78]
222D232	29.5 [1.16]	18.8 [.74]	29.5 [1.16]	8.4 [.33]	146.3 [5.76]	20.8 [.82]
222D242	34.0 [1.34]	22.9 [.90]	34.0 [1.34]	9.7 [.38]	172.2 [6.78]	21.8 [.86]
222D253	37.3 [1.47]	29.5 [1.16]	37.3 [1.47]	10.4 [.41]	185.2 [7.29]	24.4 [.96]
222D263	43.7 [1.72]	34.0 [1.34]	43.7 [1.72]	12.2 [.48]	213.6 [8.41]	27.4 [1.08]
222D274	50.0 [1.97]	41.1 [1.62]	50.0 [1.97]	14.2 [.56]	224.5 [8.84]	29.5 [1.16]
222D285	62.7 [2.45]	47.0 [1.85]	62.7 [2.47]	17.5 [.69]	227.3 [8.95]	33.3 [1.31]
222D296	69.3 [2.73]	59.7 [2.35]	69.3 [2.73]	19.6 [.77]	233.4 [9.19]	35.1 [1.38]
222D299	81.8 [3.22]	67.1 [2.64]	81.8 [3.22]	22.9 [.90]	237.0 [9.33]	44.5 [1.75]



Lipped, Bulbous Boots

202D1 Straight Boots: Mil Spec Variants

Part No.	H		J		P ±10%
	Min.	Max.	Min.	Max.	
	a	b	a	b	b
202D121	23.3 [0.92]	10.5 [0.41]	23.3 [0.92]	5.6 [0.22]	38.1 [1.50]
202D132	28.4 [1.12]	14.3 [0.56]	28.4 [1.12]	6.6 [0.26]	54.9 [2.16]
202D142	31.0 [1.22]	17.8 [0.70]	31.0 [1.22]	7.2 [0.28]	66.8 [2.63]
202D153	36.0 [1.42]	22.4 [0.88]	36.0 [1.42]	8.4 [0.33]	80.0 [3.15]
202D163	42.7 [1.68]	28.2 [1.11]	42.7 [1.68]	9.9 [0.39]	103.6 [4.08]
202D174	51.8 [2.04]	35.1 [1.38]	51.8 [2.04]	15.8 [0.62]	130.3 [5.13]
202D185	66.0 [2.60]	44.5 [1.75]	66.0 [2.60]	20.4 [0.80]	165.1 [6.50]
202D196	81.7 [3.22]	57.6 [2.27]	81.7 [3.22]	25.4 [1.00]	177.8 [7.00]

222D1 Right-Angle Boots: Mil Spec Variants

Part No.	H		J		P ±10%	R ±10%
	Min.	Max.	Min.	Max.		
	a	b	a	b	b	b
222D121	23.4 [0.92]	10.4 [0.41]	23.4 [0.92]	5.6 [0.22]	21.3 [0.84]	22.6 [0.89]
222D132	28.4 [1.12]	14.2 [0.56]	28.4 [1.12]	6.6 [0.26]	33.8 [1.33]	27.2 [1.07]
222D142	31.0 [1.22]	17.8 [0.70]	31.0 [1.22]	7.1 [0.28]	36.6 [1.44]	31.0 [1.22]
222D152	36.0 [1.42]	22.4 [0.88]	36.0 [1.42]	8.4 [0.33]	43.7 [1.72]	35.1 [1.38]
222D163	42.7 [1.68]	28.2 [1.11]	42.7 [1.68]	9.9 [0.39]	53.6 [2.11]	43.9 [1.73]
222D174	51.8 [2.04]	35.1 [1.38]	51.8 [2.04]	15.7 [0.62]	78.0 [3.07]	52.8 [2.08]
222D185	66.0 [2.60]	44.5 [1.75]	66.0 [2.60]	20.3 [0.80]	97.5 [3.84]	66.0 [2.60]
222D196	81.8 [3.22]	60.5 [2.38]	81.8 [3.22]	25.4 [1.00]	117.9 [4.64]	83.8 [3.30]

Transitions

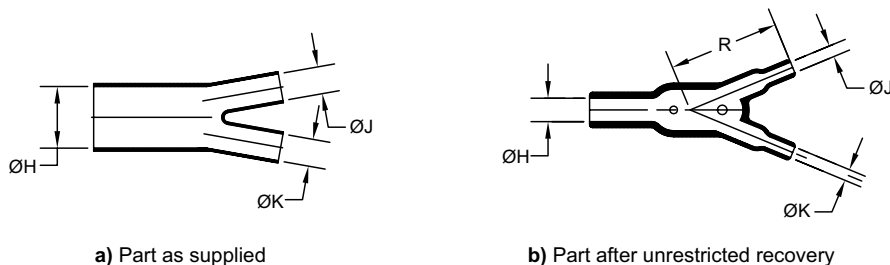

Part No.	H		J		K		P ±10%	R ±10%
	Min.	Max.	Min.	Max.	Min.	Max.		
	a	b	a	b	a	b	b	b
382A012	13.2 [0.52]	6.10 [0.24]	6.6 [0.26]	3.3 [0.13]	6.6 [0.26]	3.3 [0.13]	22.4 [0.88]	19.3 [0.76]
382A023	26.9 [1.06]	12.4 [0.49]	13.2 [0.52]	6.10 [0.24]	13.2 [0.52]	6.10 [0.24]	38.1 [1.50]	43.2 [1.70]
382A034	38.6 [1.52]	18 [0.71]	26.9 [1.06]	12.4 [0.49]	26.9 [1.06]	12.4 [0.49]	65.5 [2.58]	78.7 [3.10]
382A046	55.6 [2.19]	25.9 [1.02]	26.9 [1.06]	12.7 [0.50]	26.9 [1.06]	12.7 [0.50]	85.1 [3.35]	94 [3.70]



Micro-Molded Parts

Straight Micro-Molded Parts

Part No.	H		J		P ±10%
	Min.	Max.	Min.	Max.	
	a	b	a	b	
204W201	10 [0.39]	5.2 [0.20]	9 [0.35]	1.5 [0.06]	20 [0.79]
203W301	10 [0.39]	5.8 [0.23]	10 [0.39]	2.2 [0.09]	29 [1.14]
203W301-*-G02	10 [0.39]	5.8 [0.23]	6.0 [0.24]	2.2 [0.09]	19 [0.75]
202K111-*-01	17 [0.67]	6.9 [0.27]	17 [0.67]	3.0 [0.12]	29 [1.14]
202A111-X-G07	17 [0.67]	7.9 [0.31]	17 [0.67]	2.2 [0.09]	25 [0.98]
204W221	11 [0.43]	9.3 [0.37]	11 [0.43]	2.1 [0.08]	19 [0.75]

Right-Angled Micro-Molded Parts

Part No.	H		J		P ±10%	R ±10%
	Min.	Max.	Min.	Max.		
	a	b	a	b		
224W201	11 [0.43]	5.2 [0.20]	9 [0.35]	1.6 [0.06]	13 [0.51]	11.5 [0.45]
223W601	10 [0.39]	6.3 [0.25]	6 [0.24]	2 [0.08]	12.5 [0.49]	11.5 [0.45]
224W221	11 [0.43]	9.3 [0.37]	11 [0.43]	2.1 [0.08]	12.3 [0.48]	13 [0.51]
222A511	2.3 [0.09]	1.7 [0.07]	2.3 [0.09]	1 [0.04]	12.7 [0.50]	6.1 [0.24]
203W301	10 [0.39]	5.8 [0.23]	10 [0.39]	2.2 [0.09]	29 [1.14]	21 [0.83]

Micro-Molded Transitions

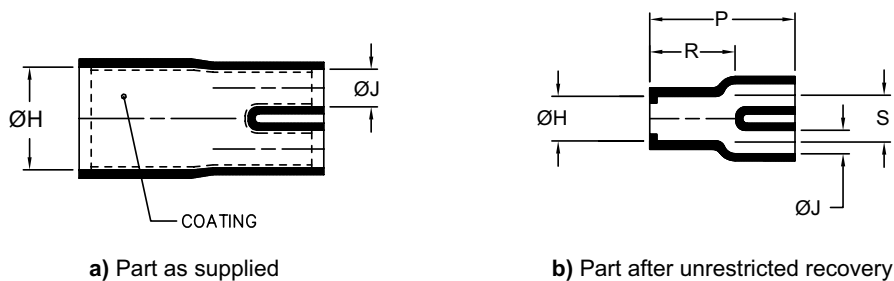

Part No.	H		J		P ±10%	R ±10%	S ±10%
	Min.	Max.	Min.	Max.			
	a	b	a	b			
302A115-X-XX	11.05 [0.44]	6.35 [0.25]	5.59 [0.22]	2.54 [0.10]	20.62 [0.81]	14.27 [0.56]	4.77 [0.19]



Raychem Application Tooling

The Tools to Make Every Connection Count

HIGH QUALITY

- Manufactured to TE Connectivity's strict quality standards
- Tools are designed to make every job easy and trouble-free
- Made from the highest quality materials for low cost of ownership

EASY TO USE

- Designed and developed with the operator in mind
- Convenient, easy to use features make installations faster and easier
- More choice in tooling, from simple hand tools to advanced, automatic operation

APPLICATION SPECIFIC

- Tools offered by TE are designed to aid in the installation of TE wire and cable products
- Decades of experience are applied to the development of all TE installation tools
- Choose from a wide range of tools for any cable management task

For more information on tooling, order our Raychem Application Tooling brochure, literature number 1-1773872-1. Or visit te.com/raychem-tooling

TE Connectivity (TE) offers a variety of dependable hand and bench-mount tools for crimping Raychem devices and heating heat-shrinkable products. The tools help give you more accuracy in terminations—increasing productivity, reducing rework, and taking the guesswork out of procedures. With easy-to-use controls and ergonomic design, Raychem tools help make the job go faster and easier.



CV1981 and CV1983 Series ThermoGun Heating Tools

ThermoGun heating tools are used for installation of TE heat-shrink products, molded parts, and SolderSleeve terminations.



Raychem Heat Guns

Tools are designed for installation of TE heat-shrink products and SolderSleeve devices.

LET'S CONNECT

We make it easy to connect with our experts and are ready to provide all the support you need. Just call your local support number or visit www.te.com/industrial to chat with a Product Information Specialist.

Technical Support

te.com/support-center

North America	+1 800 522 6752	Asia Pacific	+86 400 820 6015
North America (Toll)	+1 717 986 7777	Japan	+81 044 844 8180
EMEA/South Africa	+800 0440 5100	Australia	+61 2 9554 2695
EMEA (Toll)	+31 73 624 6999	New Zealand	+64 (0) 9 634 4580
India (Toll-Free)	+800 440 5100		

te.com/moldedparts

AMP, AGASTAT, CII, DEUTSCH, HARTMAN, INSTALITE, KILOVAC, LL ROWE, MICRODOT, NANONICS, POLAMCO, Rayaten, Raychem, SEACON, SolderSleeve, Tinel-Lock, Uniboot, VERSAFIT, Zerohal, TE, TE Connectivity and the TE connectivity (logo) are trademarks of the TE Connectivity Ltd. family of companies. Other products, logos, and company names mentioned herein may be trademarks of their respective owners.

While TE Connectivity (TE) has made every reasonable effort to ensure the accuracy of the information herein, nothing herein constitutes any guarantee that such information is error-free, or any other representation, warranty or guarantee that the information is accurate, correct, reliable or current. The TE entity issuing this publication reserves the right to make any adjustments to the information contained herein at any time without notice. All implied warranties regarding the information contained herein, including, but not limited to, any implied warranties of merchantability or fitness for a particular purpose are expressly disclaimed. The dimensions herein are for reference purposes only and are subject to change without notice. Specifications are subject to change without notice.

Consult TE for the latest dimensions and design specifications.

© 2016 TE Connectivity Ltd. family of companies All Rights Reserved.

1-1773853-4 12/16

X-ON Electronics

Largest Supplier of Electrical and Electronic Components

Click to view similar products for [TE Connectivity](#) manufacturer:

Other Similar products are found below :

[D38999/24FJ4AN](#) [570416-000](#) [CLTEQ-M81CE-SSRELAY-4-20V](#) [4-1195131-0](#) [650069-000](#) [SMD100-2](#) [358838-000](#) [CB-1022B-78](#)
[RM707012](#) [RP410012](#) [MMS42](#) [1-640426-8](#) [2EDL4CM](#) [DTS20W19-11PD-3028-LC](#) [RM202615](#) [NC6-P104-06](#) [MSPS103B](#) [DTS26F21-](#)
[41HE-LC](#) [DTS26F21-41AE](#) [DTS26F21-41PE-LC](#) [DTS26F21-11SE-3028-LC](#) [30DCB6](#) [1932144-1](#) [293545-4](#) [LVR125S](#) [MS27466T25F4PB](#)
[CKB-38-78010](#) [TR04AI-TINELLOCKRING](#) [1206SFF150F/63-2](#) [D38999/20JB35HA](#) [TE1500A2R2J](#) [D38999/20WC8BB](#) [DTS24F19-11SC-](#)
[3028-LC](#) [D38999/24WG11HA](#) [D38999/24WG11HN](#) [MS27467T21F11H](#) [DJT16E21-11HA](#) [MS27467T21F35J](#) [MS27467T21F11J](#)
[MS27467T21F16H-LC](#) [MS27467T21F35H](#) [MS27467T21F41H-LC](#) [1206SFH150F/24-2](#) [RP330024](#) [DJT16E21-11PA-LC](#) [DJT16E21-11HA-](#)
[LC](#) [DJT16E21-11AA](#) [MS27467T21B11JA](#) [DJT16E21-11JA](#) [MS27467T21B11JA-LC](#)