

Mil-Spec Connectors & Accessories



DEUTSCH ECD

Defense / Aerospace Operations . . .

is the world's premier manufacturer of electrical interconnection devices for use in defense, aerospace, and commercial applications. Whether you need an interconnection device for a commercial or military aircraft, missile, tank, truck transmission or a host of other applications, Deutsch has the solution you're looking for.

Deutsch ECD Defense Aerospace Operations

5733 W. Whittier Ave., Hemet CA (USA) 92545
Phone 909/765-2200 • FAX 909/922-1544

DG123 System Composite Connector System

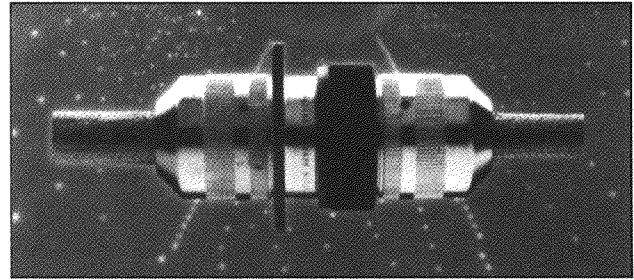

The Deutsch DG123 system is a fully tooled and tested composite interconnection system providing the electronic industry with a proven, superior, high-performance systems approach to cylindrical interconnections.

Our advanced composite interconnection system provides today's engineer with solutions for tomorrow's design requirements. Available in 17 shell sizes and 92 insert arrangements, the DG123 system includes field terminable fiber optic and data bus contacts, lanyard release plugs and a vast array of high-performance, lightweight rear accessories.

The DG123 interconnection system is capable of withstanding highly corrosive environments while providing outstanding EMI protection and lighter weight. These key features, combined with the increased durability of the DG123 system, result in extended life cycle cost savings.

This is the DG123 interconnect system, advancing designs through advanced technology from Deutsch.

Utilizing advanced materials and processes combined with field proven technology, the Deutsch DG123 system has solved the industry's most pressing problems of extreme corrosion and excess weight.

The heart of this system is the contact, a design based on proven MIL-C-39029 specifications and utilizing an advanced manufacturing process.

This Deutsch Process produces a contact that has a dense, smooth flow of the base material, providing a superior surface for the application of Deutschcoat V. The combination of these materials and processes allow Deutsch to produce a contact that is rated to 1500 cycles of durability, three times the life of a standard contact.

The contact is retained in the composite shell by an all dielectric insert. The insert construction utilizes redundant silicone sealing techniques combined with the Deutsch time tested dielectric retention. This method features retention fingers not subject to corrosion.

The insert is locked into a metalized composite shell that provides superior EMI protection, impressive durability and ruggedness.

Historically, rear hardware has played a secondary role in interconnection design. However, in order to meet the design goals of the DG123 it was imperative to consider the system as a whole, "backshell to backshell". This allowed Deutsch to design a series of high performance, lightweight rear accessories capable of terminating the vast majority of cable/harness requirements. The resulting DG123 system exceeds the "connector only" shielding effectiveness requirements of MIL-C-38999 series III and IV. This systems approach to solving EMI/RFI design problems is truly unique and by itself makes the DG123 invaluable.



DG123A Insert Arrangements

09-35 6 SIZE 220 CONTACTS 09-98 3 SIZE 20 CONTACTS 11-05 5 SIZE 20 CONTACTS 11-35 13 SIZE 220 CONTACTS 11-99 7 SIZE 20 CONTACTS 13-04 4 SIZE 16 CONTACTS



13-35 22 SIZE 220 CONTACTS 13-98 10 SIZE 20 CONTACTS 15-05 5 SIZE 16 CONTACTS 15-18 18 SIZE 20 CONTACTS 15-35 37 SIZE 220 CONTACTS

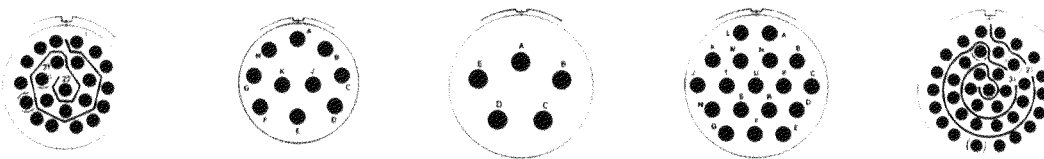

15-97 4 SIZE 16 CONTACTS
8 SIZE 20 CONTACTS 17-06 6 SIZE 12 CONTACTS 17-08 8 SIZE 16 CONTACTS 17-26 26 SIZE 20 CONTACTS 17-35 55 SIZE 220 CONTACTS

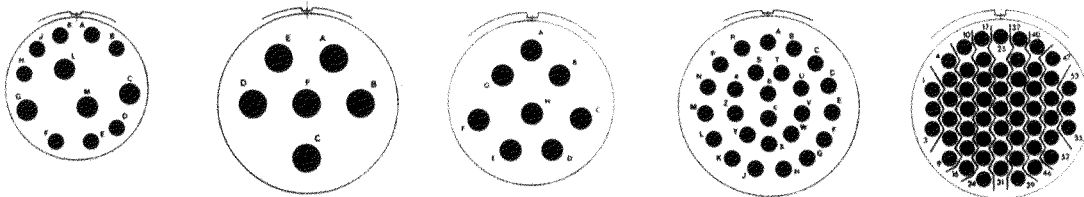

19-11 11 SIZE 16 CONTACTS 19-32 32 SIZE 20 CONTACTS 19-35 66 SIZE 220 CONTACTS 21-11 11 SIZE 12 CONTACTS 21-16 16 SIZE 16 CONTACTS

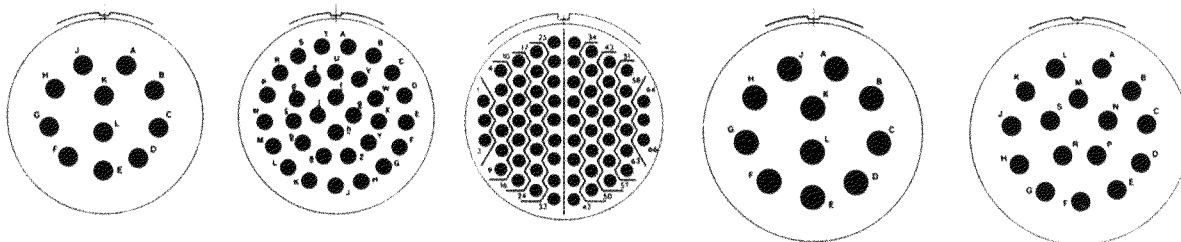

This information is for reference only. Consult factory for envelope drawings, updated specifications, and additions to the product line.



DG123A Insert Arrangements

21-35
79 SIZE 22D CONTACTS

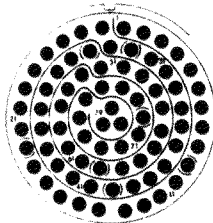

21-41
41 SIZE 20 CONTACTS

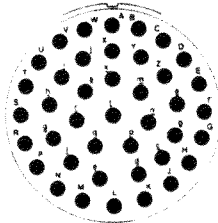

23-21
21 SIZE 16 CONTACTS

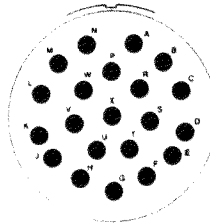

23-35
100 SIZE 22D CONTACTS

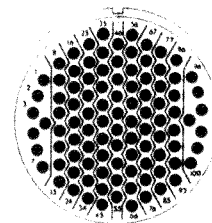

23-53
53 SIZE 20 CONTACTS

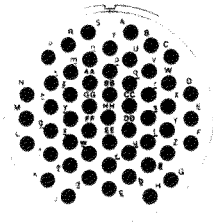

23-55
55 SIZE 20 CONTACTS

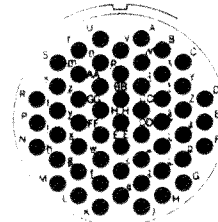

25-04
8 SIZE 16 CONTACTS
48 SIZE 20 CONTACTS

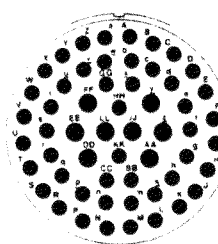

25-19
19 SIZE 12 CONTACTS

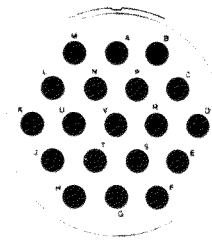

25-20
3 SIZE 8 CONTACTS
4 SIZE 12 CONTACTS
13 SIZE 16 CONTACTS
10 SIZE 20 CONTACTS

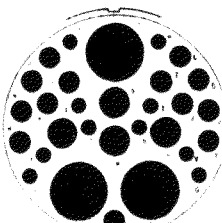

25-24
12 SIZE 12 CONTACTS
12 SIZE 16 CONTACTS

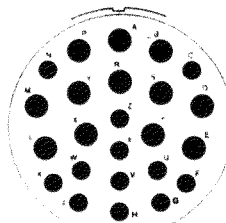

25-29
29 SIZE 16 CONTACTS

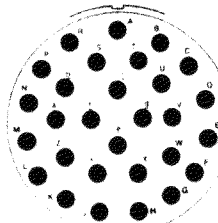

25-35
128 SIZE 22D CONTACTS

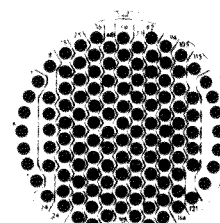

25-61
61 SIZE 20 CONTACTS

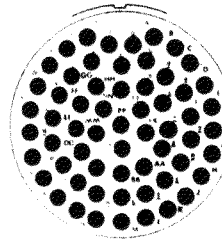

Arrangements are shown looking at pin face (socket is opposite). Cavity identifying letters or numbers are for reference only. Actual marking shall be as required by applicable specifications.



DG123A Connector Part Numbers

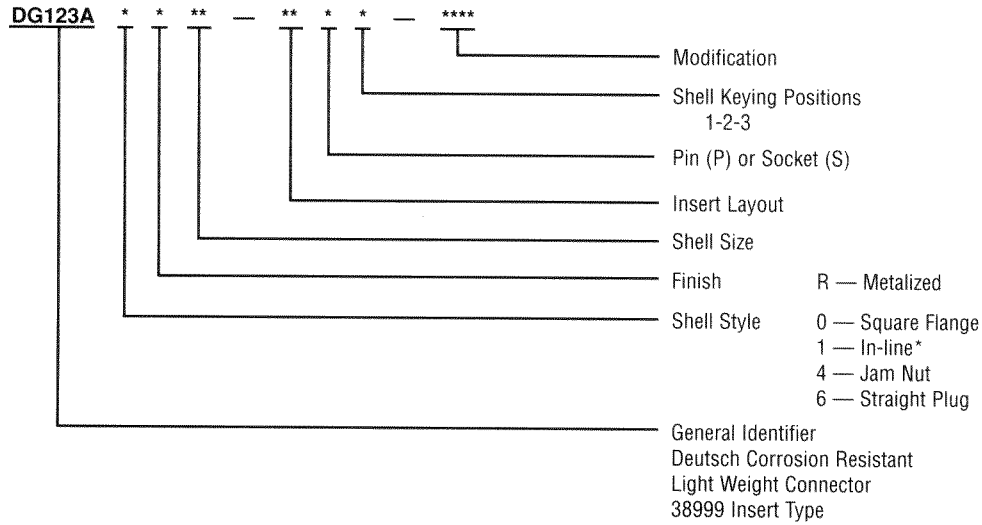

Contact & Tooling Information

DG123A

Size	Contact Deutsch Part Number	Style	Wire Gage	Crimp Tool Positioner	Military Insertion Extraction Tool	Sealing Plugs Deutsch Part Number	Strip Length ±.003	Color Code
22D	12331-22	PIN	22 THRU 28	1 (M22520/7-07)	M81969/14-01	MS27488-22	.160-.190	GREEN
22D	12333-22	SOCKET	22 THRU 28	1 (M22520/7-05)	M81969/14-01	MS27488-22	.160-.190	GREEN
20	12331-20	PIN	20 THRU 24	2 (M22520/1-04)	M81969/14-11	4113-4-2001	230-.260	RED
20	12333-20	SOCKET	20 THRU 24	2 (M22520/1-04)	M81969/14-11	4113-4-2001	230-.260	RED
16	12331-16	PIN	20 THRU 16	2 (M22520/1-04)	M81969/14-03	0613-1-1601	230-.260	BLUE
16	12333-16	SOCKET	20 THRU 16	2 (M22520/1-04)	M81969/14-03	0613-1-1601	230-.260	BLUE
12	12331-12	PIN	12 THRU 14	2 (M22520/1-04)	M81969/14-04	0613-1-1201	230-.260	YELLOW
12	12333-12	SOCKET	12 THRU 14	2 (M22520/1-04)	M81969/14-04	0613-1-1201	230-.260	YELLOW
8	6162-283-0877	TWINAX-PIN	M17/176-00002	SEE DATA SHEET	114008	6104-233-0802		
8	6162-284-0877	TWINAX/SOCKET	M17/176-00002	SEE DATA SHEET	114008	6104-233-0802		

Contact & Tooling Notes (1) Body material: Per MIL-C-39029, Composition A.

(2) For contact size 22D, use M22520/7-01 basic crimp tool. For contact size 20 thru 12, use M22520/1-01 basic crimp tool.

*Consult factory for availability



X-ON Electronics

Largest Supplier of Electrical and Electronic Components

Click to view similar products for [Standard Circular Connector](#) category:

Click to view products by [TE Connectivity](#) manufacturer:

Other Similar products are found below :

[5M2530B10P](#) [600259N006](#) [600273N007](#) [6134-336-13149](#) [6134-337-11149](#) [6134-337-2390](#) [6134-341-17149](#) [6280-4SG-516](#) [6280-7SG-3DC](#)
[6290](#) [6291A](#) [66200A-10](#) [680-SMG](#) [681-PMG](#) [CXS3102A14S2P](#) [CXS3102A181S](#) [7271-6SG-300](#) [7282-3PG-300-CH3](#) [75-474618-01S](#) [75-](#)
[474618-04P](#) [75-474618-04S](#) [799539-000](#) [MI8-SE](#) [805-005-07NF11-19PC](#) [805-005-07NF15-7PA](#) [8280-4PG-516](#) [8280-7PG-519](#) [8282-5PG-](#)
[519](#) [836783-1](#) [MP-4102-25P-C](#) [862256-1](#) [864019-2](#) [866857-1](#) [867865-1](#) [PT01SP-14-18P](#) [PT08P-14-5S](#) [120-1833-000](#)
[QCM019PC2DC012B](#) [1-2069279-1](#) [121583-0217](#) [121667-0020](#) [129591AU](#) [1000B BULK](#) [RD10A16-19-P6CS051/1](#) [RD10A20-31-](#)
[P8CS051/1](#) [RD16A14-12-S6CS051/2](#) [1301240290](#) [1301240347](#) [1301860202](#) [1301240268](#) [1301240275](#)