

Mil-Spec Connectors & Accessories



DEUTSCH ECD

Defense / Aerospace Operations . . .

is the world's premier manufacturer of electrical interconnection devices for use in defense, aerospace, and commercial applications. Whether you need an interconnection device for a commercial or military aircraft, missile, tank, truck transmission or a host of other applications, Deutsch has the solution you're looking for.

Deutsch ECD Defense Aerospace Operations

5733 W. Whittier Ave., Hemet CA (USA) 92545
Phone 909/765-2200 • FAX 909/922-1544

MIL-C-38999 Series IV

General Description

DEUTSCH DIV SERIES

The Deutsch DIV™ connector is a MIL-C-38999 design that evolved, through logic and necessity, from the specifications of the previous 38999 series. It has become the industry's premier environmental connector in areas where vibration, shock and EMI/EMP require the most any connector can be expected to do, or circumstances when there is no second chance, where reliability is essential.

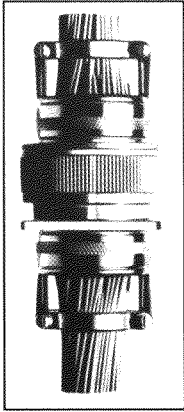

EMI/EMP: The DIV™ was built to strengthen its resistance to, and/or suppression of interfering signals. Special “grounding fingers” form a 360° circle just

inside the shell, acting as a shield. The connector is actually grounded when the shells meet, even before the contacts engage.

Specially designed dielectric retention

fingers hold the contacts. The result is enhanced reliability and dielectric separation far superior to connectors using separate metal clips.

Shock and Vibration: The DIV™ uses a breech-coupling mechanism. It holds up better against severe shock and vibration. Single-unit construction and large metal lands provide a strong locking surface to ensure coupling integrity.

Hermetics: An early Deutsch innovation uses a full glass bead for hermetic sealing. Incorporated into the hermetic version of our DIV™, this design delivers continuous dielectric separation, with a leak rate of less than 1.04×10^{-7} cm³/sec., or 0.01 micron cu. ft/hr.

Installation: Ease was a prime consideration. A blue Ready-to-Mate Indicator line runs from the plug backshell across the coupling thread to the receptacle. When it's lined up, it indicates the DIV™ is ready for engagement. A push, quarter-twist-to-click and the connector is mated securely. Even for blind mating. It's that simple.

Specifications

High Impact Shock

Mated connectors, wired with MIL-C-915/60 or /63 cable and equipped with straight environmentally sealed back shells, withstand high impact shock per MIL-S-901.

Vibration With Rear Accessory Loads

Mated connectors, with weights attached to simulate heavy rear accessories, withstand the following vibration levels:

- Sine vibration per MIL-STD-202, Method 204, Condition G.
- Random vibration per MIL-STD-202, Method 214, Condition II, Letter J.

Shielding Effectiveness, (DIV™46E)

- EMI leakage attenuation greater than 90 dB at 100 MHz and greater than 65 dB through 10 GHz.
- Dynamic EMP protection greater than 90 dB from 1 to 100 MHz while subjected to 3G²/Hz random vibration.
- Shell-to-shell conductivity – 1.0 millivolts maximum. (Class F and N).

Grounding Before Contact Engagement (DIV™46E)

Grounding fingers engage .050 in. minimum prior to engagement of contacts, providing full radiation hazard and HERO protection.

Temperature Range

Class C, F, Y and N: -65°C (-85°F) to +200°C (+392°F). Class W: -65°C (-85°F) to +175°C (+347°F).

Corrosion Resistance

Class C, Y and W withstand 500 hour salt spray. Class F and N withstand 48 hour salt spray.

Fluid Resistance

Connectors withstand specified immersions in MIL-L-7808, MIL-L-23699, MIL-H-5606, Chevron M2-V, Coolanol 25, Gasoline, Ethylene Glycol, Freon TMC, and other solvents and cleaning agents.

Rear Accessory Threads

Metric rear accessory threads provide increased strength and accept standard rear hardware. An uninterrupted cylindrical surface is provided for environmentally sealed accessories.

Scoop-Proof Design

Pin contacts are recessed to prevent damage due to scooping by the mating connector shell.

Pin-to-Pin Mating Protection

Plug and receptacle cannot mate when both contain the same contact type. This prevents the failures possible with many other connectors, which permit pin to mate with pins, resulting in either lack of continuity or short circuits and severe mechanical damage.

Coupling Durability

Exceeds specifications requirements of 500 mate/unmate cycles.

This information is for reference only. Consult factory for envelope drawings, updated specifications, and additions to the product line.



Straight Plug

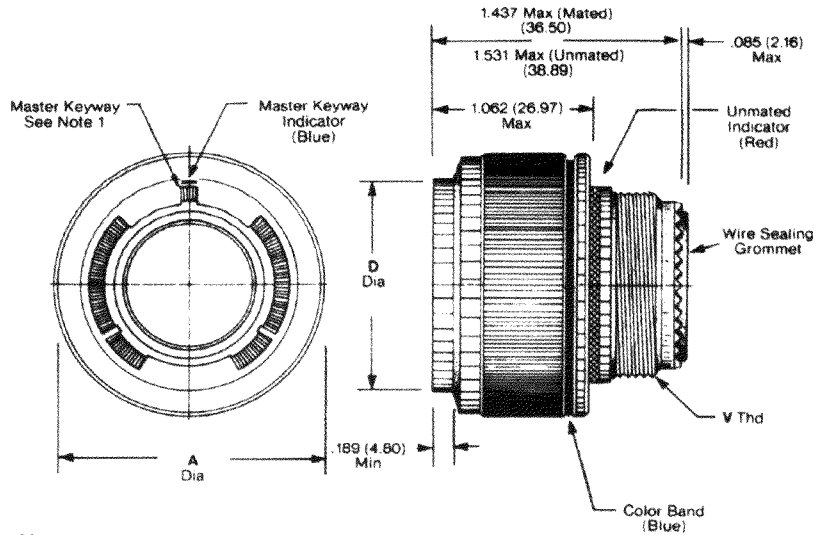

Notes:

1. Key/Keyway position N shown.
For alternate polarization, consult factory.
2. For complete part number, consult factory.

Shell Size	A Dia. Max.		D Dia. Max.		V Thd. Metric
	In.	mm	In.	mm	
11	1.047	26.6	.775	19.7	M15x1.0-6g-0.1R
13	1.220	31.0	.901	22.9	M18x1.0-6g-0.1R
15	1.346	34.2	1.039	26.4	M22x1.0-6g-0.1R
17	1.472	37.4	1.149	29.2	M25x1.0-6g-0.1R
19	1.583	40.2	1.275	32.4	M28x1.0-6g-0.1R
21	1.704	43.3	1.401	35.6	M31x1.0-6g-0.1R
23	1.831	46.5	1.527	38.8	M34x1.0-6g-0.1R
25	1.957	49.7	1.649	41.9	M37x1.0-6g-0.1R

This information is for reference only. Consult factory for envelope drawings, updated specifications, and additions to the product line.



Square Flange Receptacle

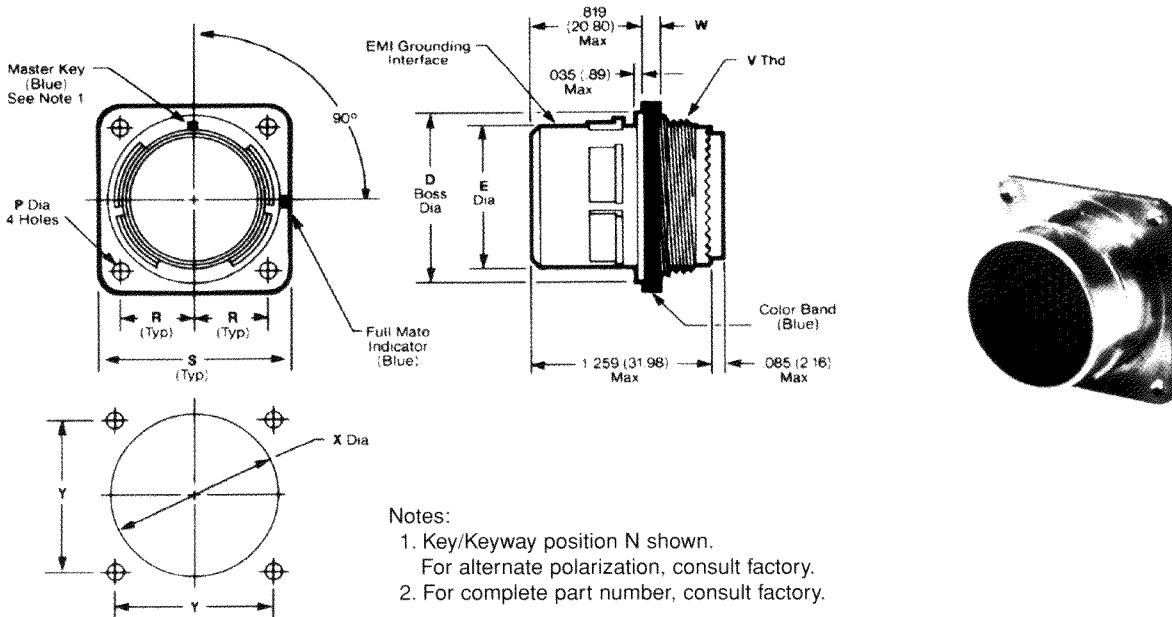

Shell Size	D Boss Dia. Max.		E Dia. Max.		P Dia. Min.		R Bsc.		S Max.	
	In.	mm	In.	mm	In.	mm	In.	mm	In.	mm
11	.793	20.14	.509	12.93	.122	3.10	.408	10.31	1.051	26.70
13	.919	23.34	.634	16.10			.453	11.51	1.145	29.08
15	1.044	26.52	.759	19.28			.4845	12.31	1.240	31.50
17	1.170	29.72	.885	22.48			.531	13.49	1.334	33.88
19	1.294	32.87	1.009	25.63			.578	14.68	1.460	37.08
21	1.419	36.04	1.134	28.80			.625	15.88	1.582	40.18
23	1.544	39.22	1.259	31.98	.142	3.81	.6875	17.46	1.708	43.38
25	1.669	42.39	1.384	35.15			.750	19.05	1.834	46.58

Shell Size	V Thd. Metric	W Max.		X Dia. Basic		Y Bsc.	
		In.	mm	In.	mm	In.	mm
11	M15x1.0-6g-0.1R	.102	2.6	.806	20.47	.812	20.62
13	M18x1.0-6g-0.1R			.932	23.87	.906	23.01
15	M22x1.0-6g-0.1R			1.057	26.85	.969	24.61
17	M25x1.0-6g-0.1R			1.219	30.96	1.062	26.97
19	M28x1.0-6g-0.1R			1.307	33.20	1.156	29.36
21	M31x1.0-6g-0.1R			1.432	36.37	1.250	31.75
23	M34x1.0-6g-0.1R	.133	3.4	1.557	39.55	1.375	34.93
25	M37x1.0-6g-0.1R			1.682	42.72	1.500	38.10



Box Mounting Receptacle

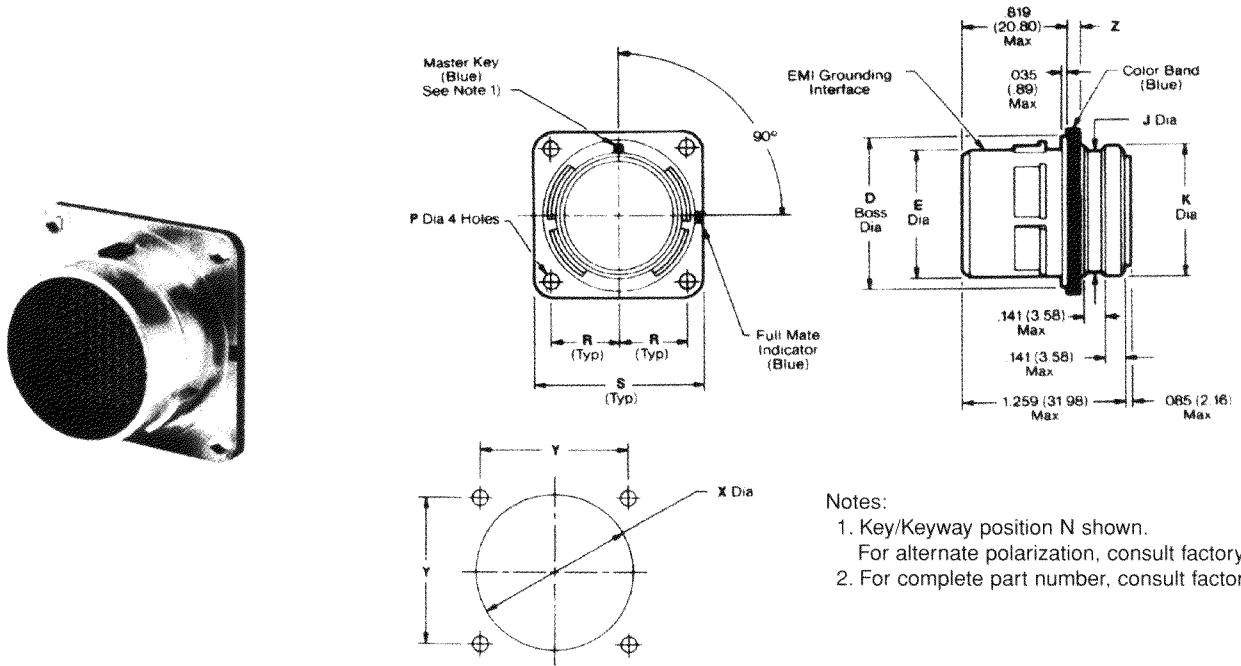

- Notes:
1. Key/Keyway position N shown. For alternate polarization, consult factory.
 2. For complete part number, consult factory.

Shell Size	D Boss Dia. Max.		E Dia. Max.		J Dia. Max.		K Dia. Max.		P Dia. Min.		R Bsc.	
	In.	mm	In.	mm	In.	mm	In.	mm	In.	mm	In.	mm
11	.793	20.14	.509	12.93	.535	13.6	.578	14.7	1.22	3.10	.406	10.31
13	.919	23.34	.634	16.10	.649	16.5	.892	17.6			.453	11.51
15	1.044	26.52	.759	19.28	.771	19.6	.818	20.8			.4845	12.31
17	1.170	29.72	.885	22.48	.897	22.8	.944	24.0			.531	13.48
19	1.294	32.87	1.009	25.63	1.003	25.5	1.051	26.7			.578	14.66
21	1.419	36.04	1.134	28.80	1.130	28.7	1.173	29.8	.626	15.88		
23	1.544	39.22	1.259	31.98	1.255	31.9	1.299	33.0	.142	3.61	.6875	17.46
25	1.669	42.39	1.384	35.15	1.378	35.0	1.425	36.2			.750	19.05

Shell Size	S Max.		X Dia. Bsc.		Y Bsc.		Z Max. Ref.	
	In.	mm	In.	mm	In.	mm	In.	mm
11	1.051	26.70	.806	20.47	.812	20.62	.102	2.6
13	1.145	29.08	.932	23.67	.906	23.01		
15	1.240	31.50	1.057	26.85	.969	24.61		
17	1.334	33.88	1.219	30.96	1.062	26.97		
19	1.460	37.08	1.307	33.20	1.156	29.36		
21	1.582	40.18	1.432	36.37	1.250	31.75	.133	3.4
23	1.708	43.38	1.557	39.55	1.375	34.93		
25	1.834	46.58	1.682	42.72	1.500	38.10		

This information is for reference only. Consult factory for envelope drawings, updated specifications, and additions to the product line.



Jam Nut Receptacle

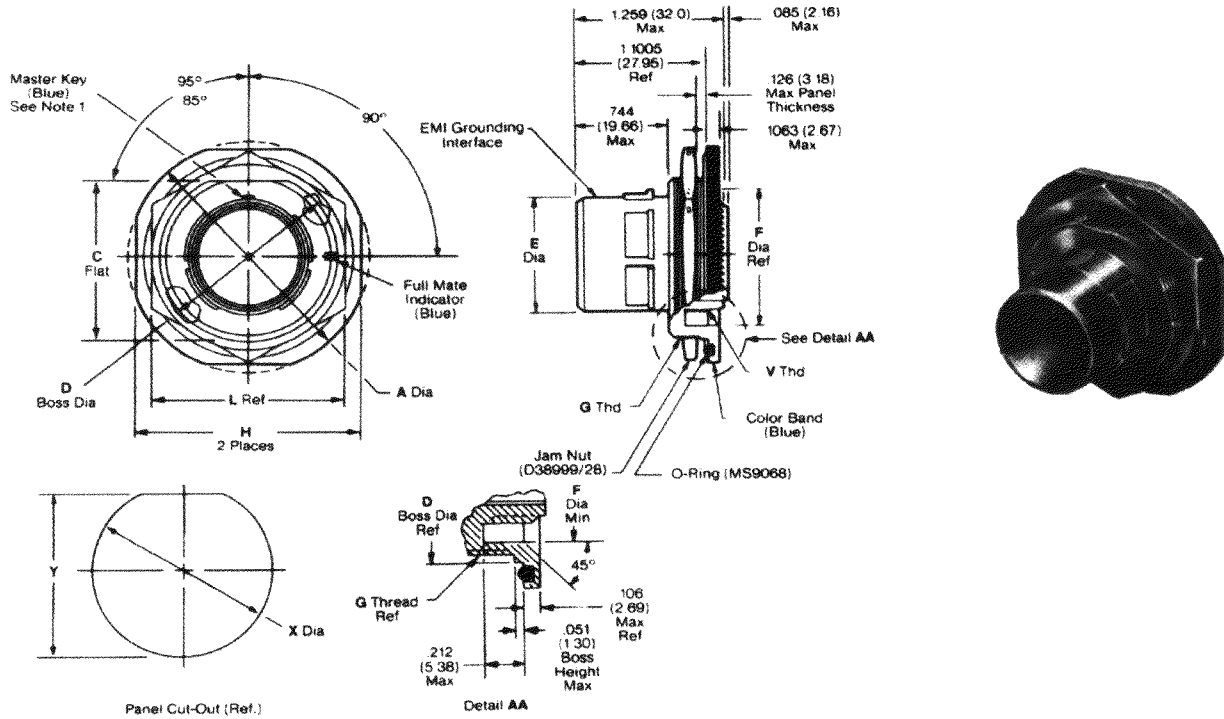

Shell Size	A Dia. Max.		C Flat Max.		D Dia. Max.		E Dia. Max.		F Dia. Min.		G Thd. Metric	H Flat Max.	
	in.	mm	in.	mm	in.	mm	in.	mm	in.	mm		in.	mm
11	1.520	38.61	.942	23.93	1.000	25.40	.509	12.83	.794	20.17	M25x1.0-6g-0.1R	1.394	35.41
13	1.642	41.71	1.066	27.08	1.125	28.58	.634	16.10	.918	23.32	M28x1.0-6g-0.1R	1.520	38.61
15	1.768	44.91	1.191	30.25	1.250	31.75	.759	19.28	1.036	26.31	M31x1.0-6g-0.1R	1.642	41.71
17	1.957	49.71	1.321	33.55	1.375	34.93	.885	22.48	1.172	29.77	M34x1.0-6g-0.1R	1.799	45.69
19	2.035	51.69	1.441	36.80	1.500	38.10	1.009	25.68	1.286	32.66	M38x1.0-6g-0.1R	1.909	48.49
21	2.157	54.79	1.566	39.78	1.625	41.28	1.134	28.80	1.412	35.86	M41x1.0-6g-0.1R	2.035	51.69
23	2.283	57.99	1.691	42.95	1.750	44.45	1.258	31.90	1.538	39.01	M44x1.0-6g-0.1R	2.157	54.8
25	2.409	61.19	1.816	46.13	1.875	47.83	1.384	35.15	1.662	42.21	M47x1.0-6g-0.1R	2.283	58.0

Shell Size	L Ref.		V Thd. Metric	X Dia. Bsc.		Y Bsc.		Recommended Packing (O Ring)
	in.	mm		in.	mm	in.	mm	
11	1.260	32.0	M15x1.0-6g-0.1R	1.017	25.83	.995	24.25	MS9068-24
13	1.417	36.0	M18x1.0-6g-0.1R	1.144	29.06	1.084	27.53	MS9068-26
15	1.614	41.0	M22x1.0-6g-0.1R	1.269	32.23	1.206	30.69	MS9068-28
17	1.814	41.0	M25x1.0-6g-0.1R	1.394	35.41	1.333	33.86	MS9068-29
19	1.811	46.0	M28x1.0-6g-0.1R	1.517	38.53	1.459	37.06	MS9068-30
21	1.968	50.0	M31x1.0-6g-0.1R	1.644	41.78	1.576	40.03	MS9068-31
23	1.966	50.0	M34x1.0-6g-0.1R	1.769	44.93	1.701	43.21	MS9068-32
25	2.165	55.0	M37x1.0-6g-0.1R	1.894	48.10	1.826	46.38	MS9068-33

This information is for reference only. Consult factory for envelope drawings, updated specifications, and additions to the product line.



Insert Arrangements

(Front Face of Pin Insert Shown) Legend ○ 22D ⊖ 20 ⊕ 16 ⊕ 12

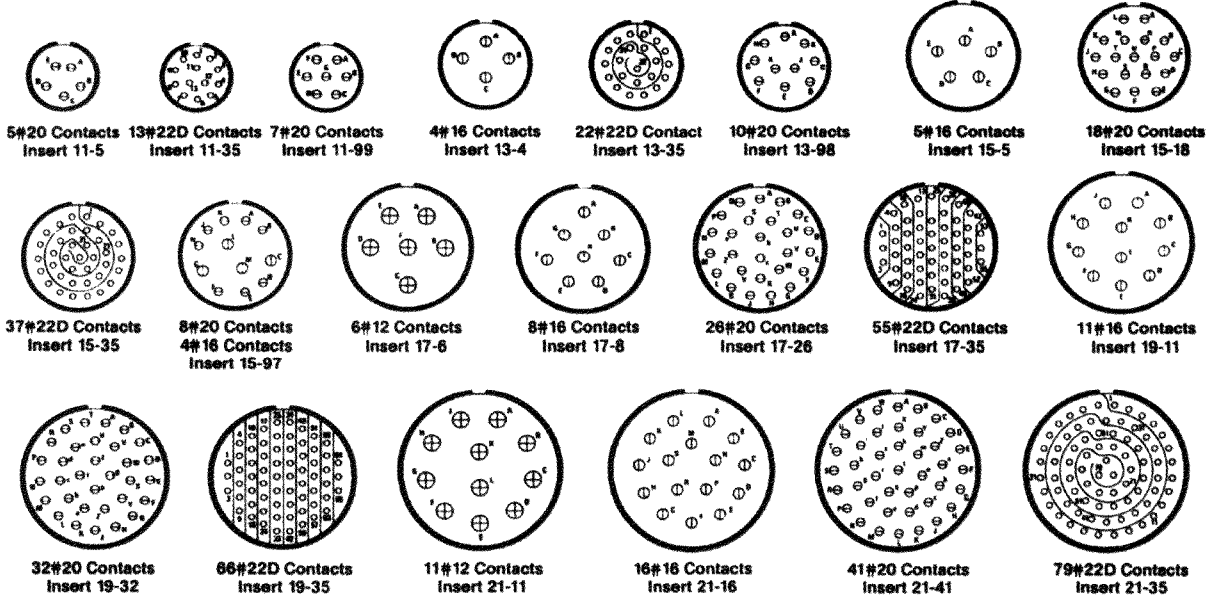

Deutsch Shell Sizes

DIX	Service Rating	Total Contacts	Contact Size			
			22D	20	16	12
11-5	I	5		5		
11-35	III	13	13			
11-99	I	7		7		
13-4	I	4			4	
13-35	III	22	22			
13-98	I	10		10		
15-5	II	5			5	
15-18	I	18		18		
15-35	III	37	37			
15-97	I	12		8	4	
17-6	I	6				6
17-8	II	8			8	
17-26	I	26		26		
17-35	III	55	55			
18-11	II	11			11	
18-32	I	32		32		
18-35	III	66	66			
21-11	I	11				11
21-16	II	16			16	
21-41	I	41		41		
21-35	III	79	79			
23-21	II	21			21	
23-35	III	100	100			
23-53	I	53		53		
23-55	I	55		55		
25-4	I	56		48	8	
25-19	I	19				19
25-24	I	24			12	12
25-29	I	29			29	
25-35	III	128	128			
25-61	I	61		61		

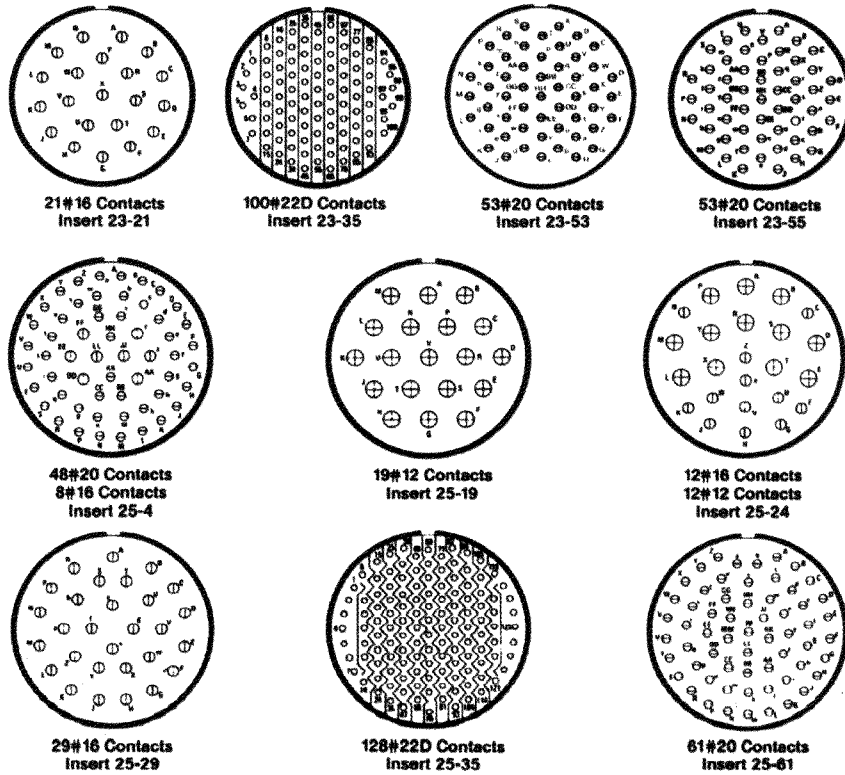

This information is for reference only. Consult factory for envelope drawings, updated specifications, and additions to the product line.



Part Numbering, Contacts

Deutsch Part Numbering

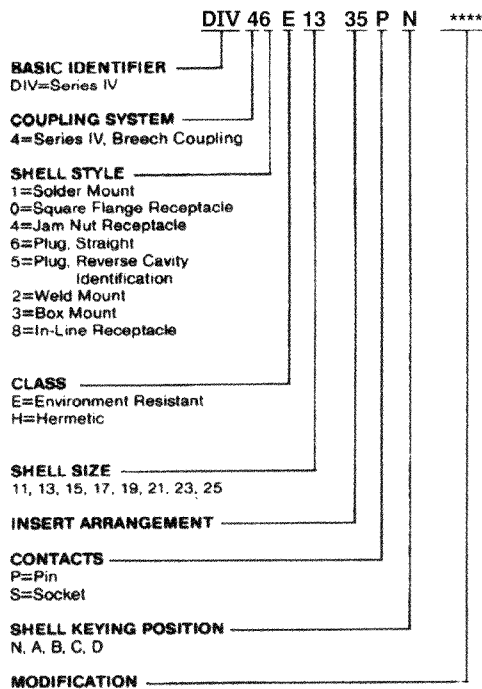

MIL-C-38999/Series IV

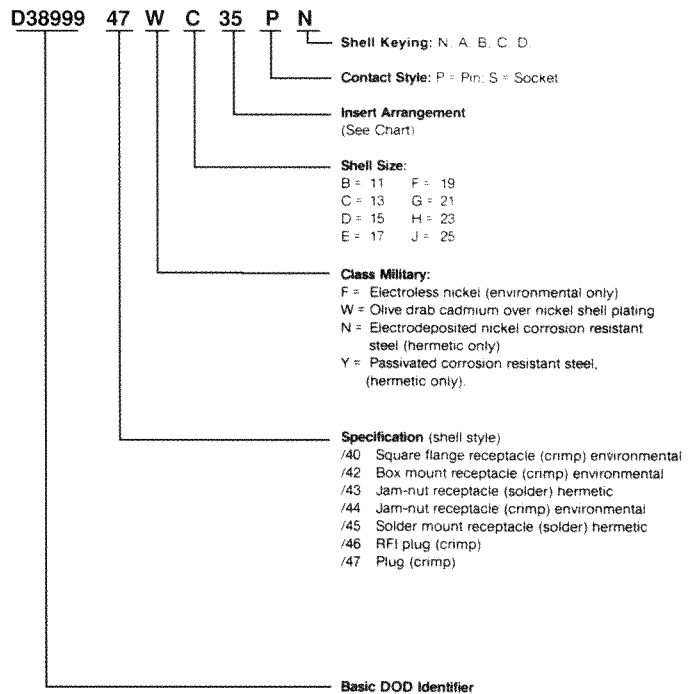

Contacts, Sealing Plugs and Assembly Tools

Contact Size	Deutsch Contacts Part Number	Installing and Removal Tool
Pin		
22D	38941-22	MIL-I-81969/14-22B
20	38941-20	MIL-I-81969/14-20
16	38941-16	MIL-I-81969/14-16
12	38941-12	MIL-I-81969/14-12
Socket		
22D	38943-22	MIL-I-81969/14-22D
20	38943-20	MIL-I-81969/14-20
16	38943-16	MIL-I-81969/14-16
12	38943-12	MIL-I-81969/14-12

Contact Size	Insulation Strip Length (inches)	Crimping Tools	Sealing Plugs
22D	.190-.190	MS22520/2 or/7	MS14197-S22
20	.230-.260	MS22520/1, /2 or/7	MS14197-S20
16	.230-.260	MS22520/1 or/7	MS14197-S16
12	.230-.260	MS22520/1	MS14197-S12



X-ON Electronics

Largest Supplier of Electrical and Electronic Components

Click to view similar products for [Circular DIN Connectors](#) category:

Click to view products by [TE Connectivity](#) manufacturer:

Other Similar products are found below :

[CTV06RQF-25-8SA-LC](#) [CTV06RQF-25-8S-LC](#) [CTV06RQW-25-8SB-LC](#) [CTV06RW-25-20P](#) [CTV06RW-25-20PA](#) [CTV06RW-25-20PB](#)
[CTV06RW-25-20PE-LC](#) [CTV06RW-25-20SB](#) [CTV06RW-25-20SE](#) [CTV07RW-17-8S\(506\)](#) [CTVP00RW-19-32S\(506\)](#) [CTVP00RW-9-35S\(506\)](#) [M83723/71R20416](#) [M83723/71R22196](#) [M83723/71W2039N](#) [M83723/71W24196](#) [M83723/71W2419N](#) [M83723/72A1404N-LC](#)
[M83723/72R1203N](#) [M83723/72W20418](#) [M83723/72W22126](#) [M83723/72W22556](#) [M83723/72W2419N](#) [M83723/72W2461N](#)
[M83723/73R2028N](#) [M83723/73R2039N](#) [M83723/73W1412N](#) [M83723/73W2039N](#) [M83723/74R1624N](#) [M83723/74R1808N](#)
[M83723/74R2212N](#) [M83723/74W1203N](#) [M83723/74W1412N](#) [M83723/74W20416](#) [M83723/74W2041N](#) [M83723/75R10058](#)
[M83723/75W2232N](#) [M83723/76R14157](#) [M83723/76R20256](#) [M83723/76W1808N](#) [M83723/76W2016N](#) [M83723/76W2461N](#)
[M83723/77W2016N](#) [M83723/78R22327](#) [M83723/78W2212N](#) [M83723/78W22556](#) [M85049/50-5F](#) [D38999/20FF11AC](#) [D38999/20FJ20BB](#)
[D38999/20FJ20SC](#)