

## Type DPL12 Series

### Key Features

12mm rotary encoder

Incremental type

Push switch option

Various shaft lengths

LED color options

Detent Options



12mm rotary incremental encoder with LED for use in electronic equipment.

Can be supplied with or without switch with customization to standard options.

### Characteristics – Electrical

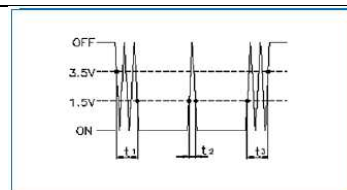

|                             |   |
|-----------------------------|---|
| Pulse                       | 24 / 360°   |
| Contact Rating              | 0.5mA 5VDC  |
| Dielectric Strength         | 300VAC / 1mA, 1 minute                                  |
| Insulation Resistance (min) | 100MΩ at 250VAC   |
| Operating Speed (RPM)       | 60 RPM  |
| Electrical Travel           | Continuous  |
| Rotational Noise            | t <sub>2</sub> = 2.0ms max (see below)                  |
| Chattering                  | t <sub>1</sub> & t <sub>3</sub> = 3.0ms max (see below) |



Code off Area V=3.5V or more  
Code on Area V=1.5V or less

|                                    |  |
|------------------------------------|--|
| LED                                | With Switch – Dual color (see below)<br>No Switch – Single color (see below)                         |
| Color Options                      | Switch – 1 = Blue / Green, 2 = Blue / Orange, 3 = Green / Red<br>No Switch – White, Red, Green, Blue |
| Switch Power Rating (where fitted) | 5VDC 10mA  |
| Switch contact Resistance          | 100MΩ max.   |
| Operating Temperature              | -10°C ~ +85°C  |
| Storage Temperature                | -40°C ~ +70°C  |

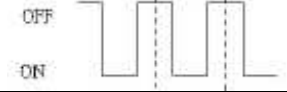
## Electrical Characteristics

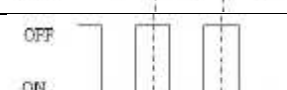
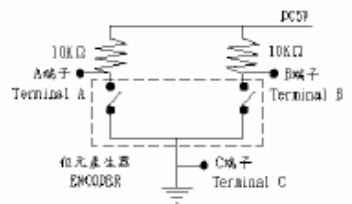
| Item                      | Conditions  |   | Specifications   |
|---------------------------|---|---|--|
| Output Signal Format      |   |   | 2 Phase different signals (signal A & signal B) Details shown below (broken line shows detent position where fitted) |
|                           | C/W   | A (Terminal A-C)  |                                   |
|                           |   | B (Terminal B-C)  |                                   |
|                           | C C/W   | A (Terminal A-C)  |                                   |
| B (Terminal B-C)          |   |  |  |
| Resolution                | Number of pulses in 360° rotation   |   | 24 pulses / 360° each phase  |
| Switching Characteristics | Measurement shall be made under the following conditions:<br>1. Shaft rotational speed: 360°/S<br>2. Test Circuit: See below<br>  |   |  |
| Sliding Noise             | Chattering<br>Specified by the signal's passage time from 3.5V to 1.5V or from 1.5V to 3.5V of each switching position (Code OFF → ON or ON → OFF)<br>NB To avoid chattering ( $t_1 - t_3$ ) please consider masking time and adding C/R filters to your circuit for pulse count design.  |   | $t_1, t_3 \leq 3\text{ms}$   |
|                           | Bounce<br>Specified by the time of voltage change exceed 1.5V in code ON area. When the bounce has code ON time less than 1ms between chattering ( $t_1$ or $t_3$ ) the voltage change shall be regarded as part of chattering, When the code ON time between two bounces is less than 1ms they are regarded as one linked bounce |   | $T_2 \leq 2\text{ms}$  |

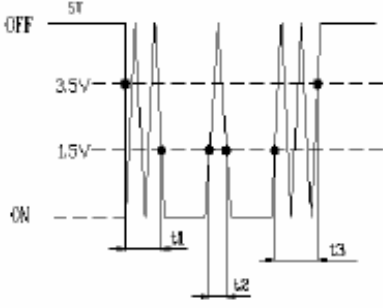
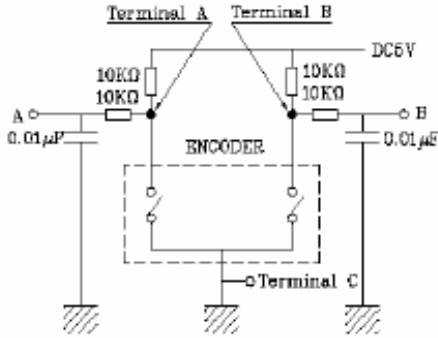
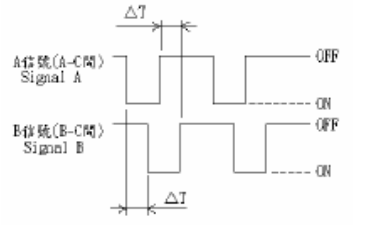
|   |   |   |
|---|---|---|
| <p>Sliding Noise<br/>(continued)</p>   | <p>Sliding Noise<br/>The voltage change in OFF area</p>   | <p>3.5V min.</p>  |
| <p>(t<sub>1</sub>, t<sub>3</sub>) Masking time to avoid chattering<br/>Code OFF area – The area in which the voltage is 3.5V or more<br/>Code ON area – The area in which the voltage is 1.5V or less</p> |   |   |
| <p>Phase<br/>Difference</p>   | <p>Measurement shall be made in the condition in which the shaft is rotated in 360° / S (constant speed)</p> <p>Rotational direction</p>  <p>Rotational Direction →</p> <p>Note: The test is conducted using equipment at constant speed 360° / S according to spec. The test result could be different under manual conditions.<br/>In order to prove the interoperability between the firmware and the encoder please test the part in real conditions</p> | <p><math>\Delta T \geq 3.5\text{msec}</math></p>  |
| <p>Insulation<br/>Resistance</p>  | <p>Measurement shall be made under the condition which a voltage of 250V D.C is applied between individual terminals and attaching plate</p>  | <p>Between individual terminals and attaching Plate:100MΩ MIN</p>   |
| <p>Dielectric<br/>Strength</p>  | <p>A voltage of 300V A.C. shall be applied for 1 min or a voltage of 360 VA.C. shall be applied for 2 sec between individual terminals and attaching plate ( Leak current : 1mA )</p>   | <p>Without arcing or breakdown</p>  |
| <p>Number and<br/>position of<br/>detents</p>   |   | <p>24 detents<br/>Step angle: 15°±3°</p>  |
| <p>Terminal<br/>Strength</p>  | <p>Push and pull static load of 5Kgf shall be applied to the shaft in the axial direction for 10sec. ( After soldering of the PC board )</p>  | <p>Without damage to. or excessive play in shaft .No excessive abnormality in rotational feeling and electrical characteristics shall be satisfied.</p> |
| <p>Rotation play at<br/>the click<br/>position</p>  | <p>Measure with jig for rotational angle</p>  | <p>4°Max</p>  |

### Endurance Characteristics

| Item            | Conditions   | Specification  |
|-----------------|--|--|
| Rotational Life | The shaft of the encoder shall be rotated to 30,000 cycles at a speed of 600 ~ 1000 cycles per hour without electrical load, after which measurement shall be made (1 cycle : rotate 360° C.C.W. rotate 360° C.W.) | Chattering: $t_1, t_3 \leq 5\text{ms}$<br>Bounce: $t_2 \leq 3\text{ms}$<br>Phase-difference: $\Delta T \geq 2.5\text{msec}$<br>Where applicable detent feeling remains.<br>All electrical specification shall be met |

### Soldering Condition

| Item           | Conditions   | Specifications   |
|----------------|--|--|
| Hand Soldering | Bit temperature: 350°C or less<br>Dwell time: 3S max.  | There shall be no deformation or cracks in molded part. No excessive abnormality in rotational feeling |
| Dip soldering  | Preheating:<br>PCB surface temp: 100°C or less<br>Preheating time: 2 minutes Max.<br>Soldering:<br>Solder temperature: 260°C±5°C<br>Immersion time: 5±1S<br>2 times max. |  |

### Switch Electrical Characteristics (Where fitted)

| Item                          | Conditions   | Specification  |
|-------------------------------|--|--|
| Contact resistance            | Measured by the electric current D.C. voltage drop method  | 100 mΩ MAX   |
| Chattering                    | Switch is operated at the rate of 1 cycle 1 sec.<br>The 1 cycle shall be OFF - ON - OFF  | Less than 10 msec  |
| Insulation Resistance         | Measurement shall be made under the condition which a voltage of 250V D.C. is applied between individual terminals and attaching plate.  | Between individual terminals and attaching plate.<br>100MΩ MIN . |
| Dielectric Strength           | A voltage of 300V A.C. shall be applied for 1 min. or a voltage of 360V A.C. shall be applied for 2 sec between individual terminals and attaching plate. ( Leak current : 1mA ) | Without damage to parts arcing or breakdown.                     |
| Switch rating (Resistor load) |  | D.C.5V 10mA  |
| Note                          | Shaft is insulated from switch terminal  |  |

### Switch Mechanical Characteristics (Where fitted)

| Item                | Conditions | Specification   |
|---------------------|------------|-----------------|
| Contact arrangement |            | S.P.S.T Push On |
| Switching stroke    |            | 0.5+0/-0.3mm    |

## Switch Mechanical Characteristics (Continued)

| Item            | Conditions | Specification |
|-----------------|------------|---------------|
| Switch strength |            | 450 ± 200gf   |

## Switch Endurance Characteristics

| Item           | Conditions   | Specification   |
|----------------|--|---|
| Operating life | The shaft of switch shall be operated 20,000 times without electronic load, after which measurements shall be made | Switch contact resistance : 200mΩ MAX<br>Switch strength: Relative to the previously Specified value +10% / -30%. Except above items specification as shown above |

## LED Common Specifications

### Single color (No Switch)

#### Circuit

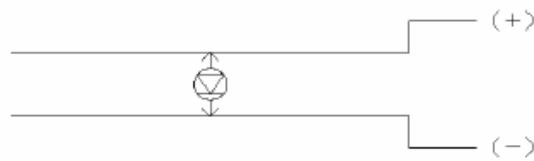

## LED Characteristics

### Reverse Voltage: 5V

| Emitted Colour | Power Dissipation | DC Forward Current | Test Conditions<br>IF = 20mA |      |
|----------------|-------------------|--------------------|------------------------------|------|
|                |                   |                    | Forward Voltage (V)          |      |
|                |                   |                    | Typ.                         | Max. |
| Red            | 60mW              | 30mA               | 1.8                          | 2.6  |
| Lawn Green     | 100mW             | 30mA               | 2                            | 2.6  |
| Blue           | 72mW              | 20mA               | 3.2                          | 3.6  |
| Orange         | 100mW             | 30mA               | 2.1                          | 2.6  |
| White          | 72mW              | 20mA               | 3.2                          | 3.6  |
| Green          | 72mW              | 20mA               | 3.2                          | 3.6  |
| Dark Orange    | 100mW             | 30mA               | 2.1                          | 2.6  |

## LED Common Specifications

Dual color (Switch)

Circuit

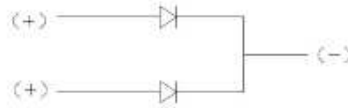

LED Characteristics

Reverse Voltage: 5V

| Emitted Colour |        | Power Dissipation (mW) | DC Forward Current (mA) | Test Conditions<br>IF = 20mA |      |      |
|----------------|--------|------------------------|-------------------------|------------------------------|------|------|
|                |        |                        |                         | Forward Voltage (V)          |      |      |
|                |        |                        |                         | Min.                         | Typ. | Max. |
| Blue / Orange  | Blue   | 75                     | 20                      | 2.7                          | 3.3  | 3.7  |
|                | Orange | 60                     | 25                      | 1.7                          | 2    | 2.4  |
| Green / Red    | Green  | 95                     | 25                      | 2.7                          | 3.3  | 3.7  |
|                | Red    | 60                     | 25                      | 1.7                          | 2    | 2.4  |
| Blue / Green   | Blue   | 75                     | 20                      | 2.7                          | 3.3  | 3.7  |
|                | Green  | 95                     | 25                      | 2.7                          | 3.3  | 3.7  |
| Red / Green    | Red    | 60                     | 25                      | 1.7                          | 2    | 2.4  |
|                | Green  | 95                     | 25                      | 2.7                          | 3.3  | 3.7  |
| Green / Orange | Green  | 95                     | 25                      | 2.7                          | 3.3  | 3.7  |
|                | Orange | 60                     | 25                      | 1.7                          | 2    | 2.4  |
| Blue / Red     | Blue   | 75                     | 20                      | 2.7                          | --   | 3.3  |
|                | Red    | 60                     | 25                      | 1.7                          | --   | 2.4  |
| White / Red    | White  | 75                     | 20                      | 2.7                          | --   | 3.7  |
|                | Red    | 60                     | 25                      | 1.75                         | --   | 2.35 |
| White / Green  | White  | 75                     | 20                      | 2.7                          | --   | 3.7  |
|                | Green  | 60                     | 25                      | 1.7                          | --   | 2.4  |

## Dimensions DPL12V

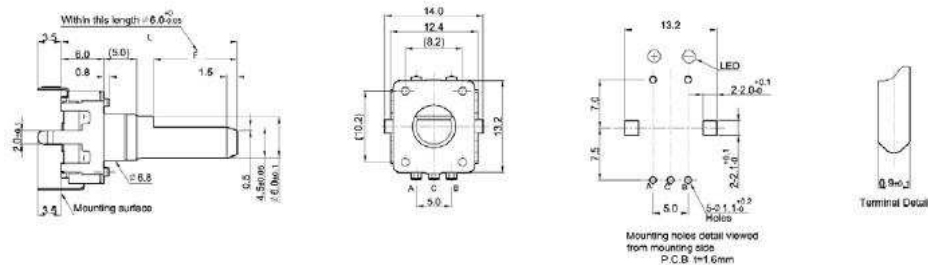

## Dimensions DPL12H

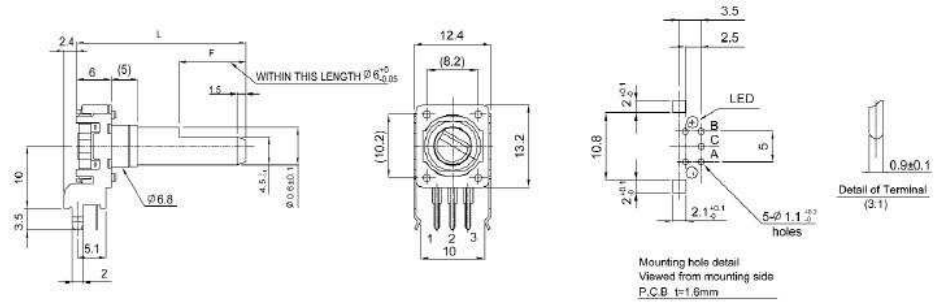

## Dimensions DPL12SV

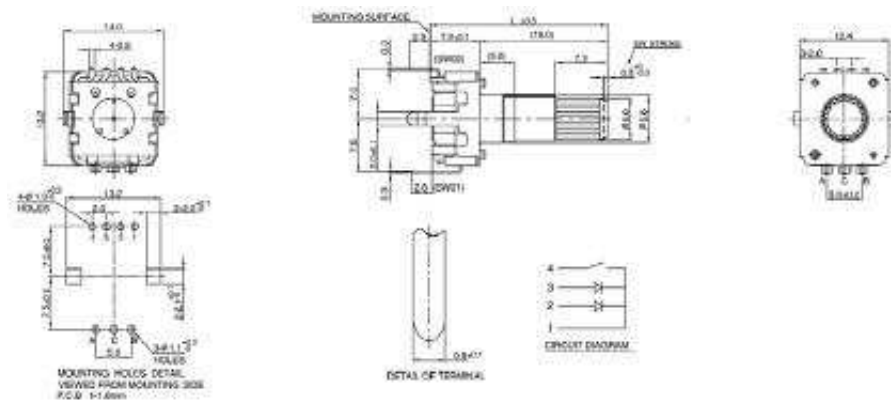

## Dimensions DPL12SH

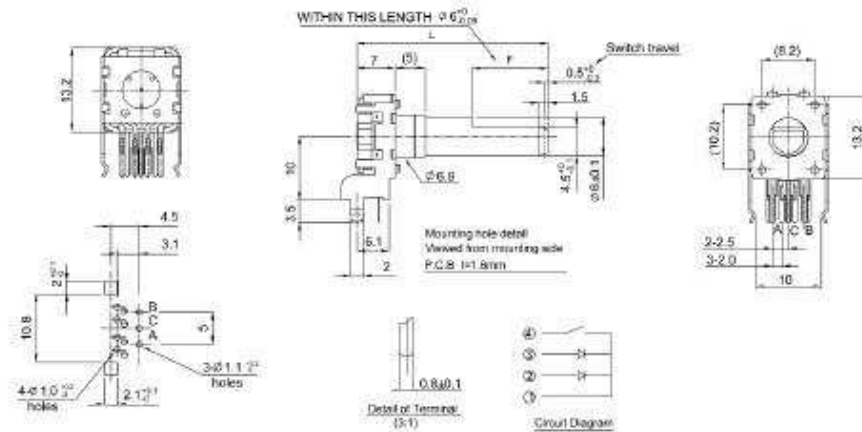

## Shaft Length – Without Switch

| Type | Dim                       | Options (mm) |    |    |
|------|---------------------------|--------------|----|----|
| K    | L (from mounting surface) | 24 only      |    |    |
| F    | L (from mounting surface) | 17.5         | 20 | 25 |
|      | F                         | 5            | 7  | 12 |

## Shaft Length – With Switch

| Type | Dim                       | Options (mm) |    |    |
|------|---------------------------|--------------|----|----|
| K    | L (from mounting surface) | 25 only      |    |    |
| F    | L (from mounting surface) | 18.5         | 21 | 26 |
|      | F                         | 5            | 7  | 12 |

## LED Color Codes

| Switch Option               | Code | Description    |
|-----------------------------|------|----------------|
| Switch<br>(Dual Color)      | 1    | Blue / Green   |
|                             | 2    | Blue / Orange  |
|                             | 3    | Green / Red    |
|                             | 4    | Red / Green    |
|                             | 5    | Green / Orange |
|                             | 6    | Blue / Red     |
|                             | 7    | White / Red    |
|                             | 8    | White / Green  |
| No Switch<br>(Single Color) | R    | Red            |
|                             | L    | Lawn Green     |
|                             | B    | Blue           |
|                             | O    | Orange         |
|                             | W    | White          |
|                             | G    | Green          |
|                             | D    | Dark Orange    |

## How To Order

| DPL12                                | V                              | N                          | 24             | A    | 20                 | F                          | R                  |
|--------------------------------------|--------------------------------|----------------------------|----------------|------|--------------------|----------------------------|--------------------|
| Common Part                          | Orientation                    | Detent                     | Pulses         | Bush | Shaft Length       | Shaft Style                | LED Color          |
| DPL12 – No Switch<br>DPL12S – Switch | V – Vertical<br>H – Horizontal | N – None<br>24 – 24 clicks | 24 – 24 pulses | 5mm  | See relevant table | F – Flatted<br>K – Knurled | See relevant table |



## X-ON Electronics

Largest Supplier of Electrical and Electronic Components

*Click to view similar products for [Encoders](#) category:*

*Click to view products by [TE Connectivity](#) manufacturer:*

Other Similar products are found below :

[6-1393048-0](#) [6-1393048-5](#) [62AG22-H5-P](#) [62B22-LP-030C](#) [63K25](#) [63K32](#) [63KS100](#) [63KS64](#) [63R100](#) [63R50-020](#) [63RS256-060](#) [700-09-36](#)  
[RE12D300-201-1](#) [1393047-3](#) [2-1393047-2](#) [T101-5C2-111-M1](#) [T101-5C3-111-M1](#) [T101-5C4-111-M1](#) [385001M0439](#) [385001M0216](#)  
[V23401H1409B101](#) [V23401T8002B802](#) [V23401U6019B609](#) [E69-1](#) [E69DF10](#) [E69-FCA](#) [62B11-LP-100S](#) [62B11-LPP-040C](#) [62N11-P](#)  
[62S22-H9-120S](#) [62S30-L0-200C](#) [62V15-02-080S](#) [63K64](#) [63KS100-040](#) [63R64-050](#) [63RS64](#) [700-16-16](#) [V23401D3002B301](#) [3-1393048-1](#)  
[63KS128](#) [63KS256](#) [1-1879391-5](#) [GH65C11-N-SO](#) [62S15-M0-P](#) [1393047-1](#) [E69-FCA02](#) [E69-FCA04](#) [E69-DF20](#) [E69-DF2](#) [63R50](#)