

REV
B

DRBF-3**

REVISIONS			
SYM	DESCRIPTION	DATE	APPROVED
NC	NEW RELEASE PER E.O. P17210	4-9-01	R.D.R.
A	REVISED PER E.O. P18954	7-12-05	R.D.R.
B	REVISED PER E.O. P19034	9-13-05	RDR

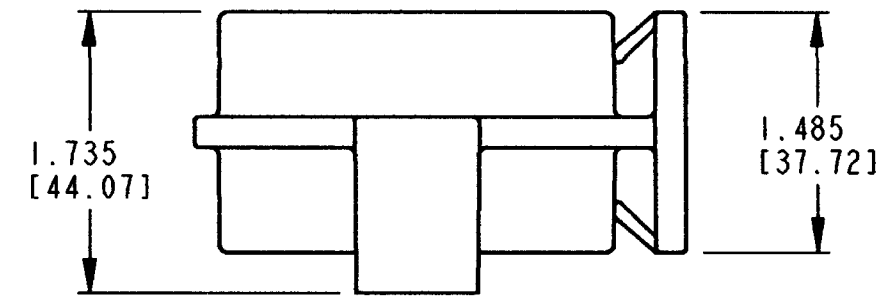
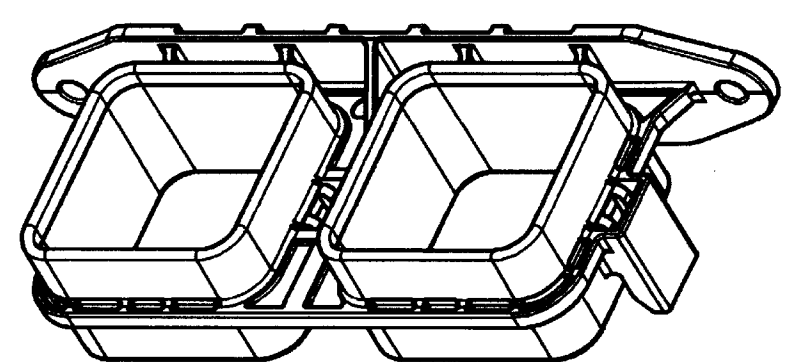

- NOTES:
1. DIMENSIONS ARE IN INCHES [mm].
 2. DIMENSION TOLERANCE: ±.025 [.64].
 3. THIS PART MATES WITH DRB12-48P*(N)E-****, DRB12-60P*(N)E-****, DRB16-48S*(N)E-****, AND DRB16-60S*(N)E-****. (* = A,B,C,D KEYS; **** = ALL MODIFICATIONS). CONSULT FACTORY FOR MODS.
 4. MATERIAL: PLASTIC
 5. SEE SHEETS 2, 3 AND 4 FOR OTHER KEY ARRANGEMENTS.

SIGNATURE & DATE	
DR	S.PALLUTH 04/04/01
CHK	R. Sullivan 9-13-05
PE	Wadsworth 9/13/05
APPD	D. Meyer 9/13/05
SCALE	NONE 1:1

FLANGE DUAL INTERFACE
KEYS: AA THRU DD
COLOR: BLACK
DRB SERIES

ENVELOPE

CP	EP063	MATL CODE
The Deutch Company DEUTSCH I.P.D. 3850 INDUSTRIAL AVE. HEMET, CALIF. 92545		
B	DRBF-3**	
DWG SIZE	CODE 11139	SHEET 1 OF 4

REV B DRBF-3**

REVISIONS			
SYM	DESCRIPTION	DATE	APPROVED
B	SEE SHEET 1	9-13-05	RDR

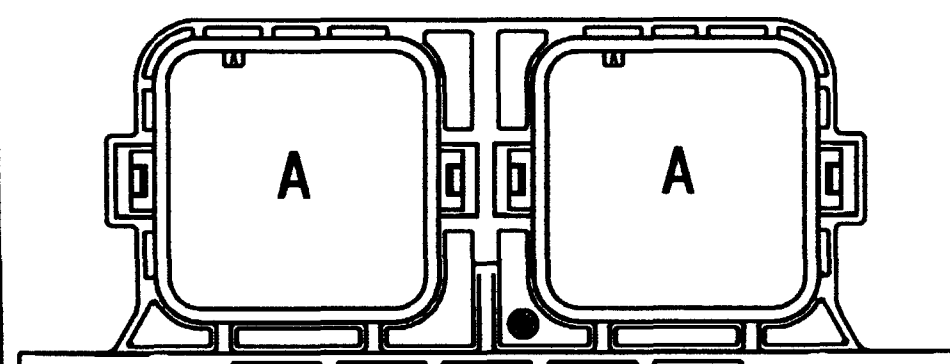

DRBF-3AA
KEYS A & A

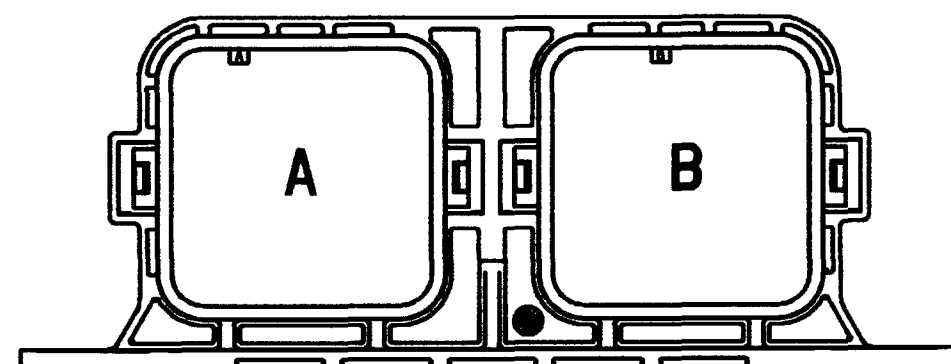

DRBF-3AB
KEYS A & B

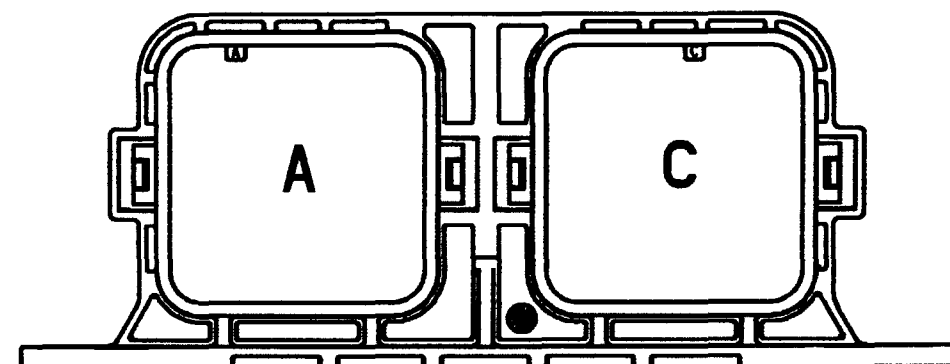

DRBF-3AC
KEYS A & C

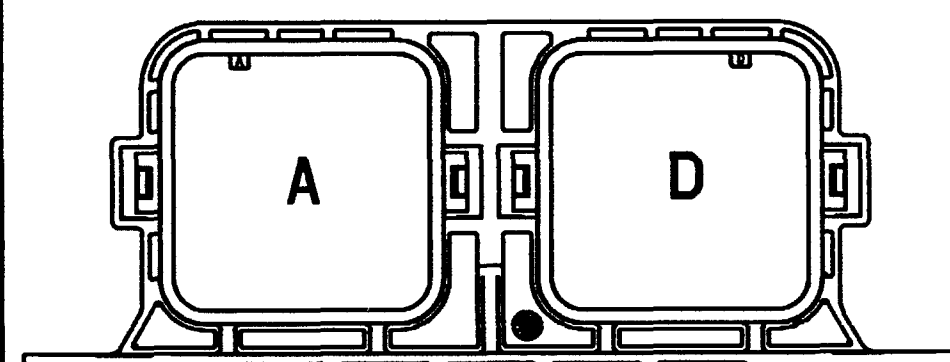

DRBF-3AD
KEYS A & D

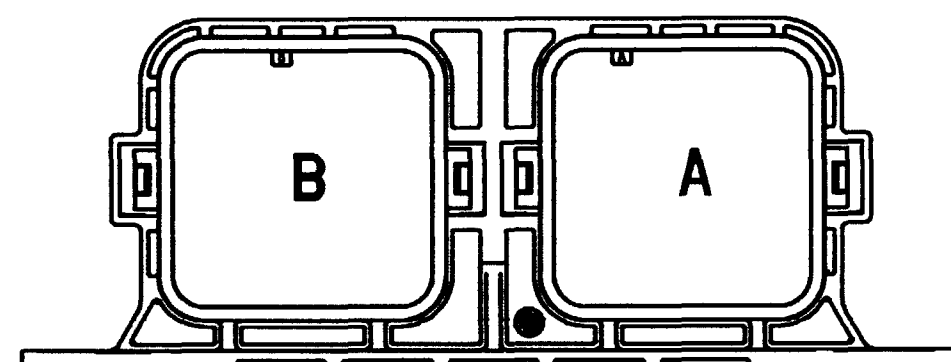

DRBF-3BA
KEYS B & A

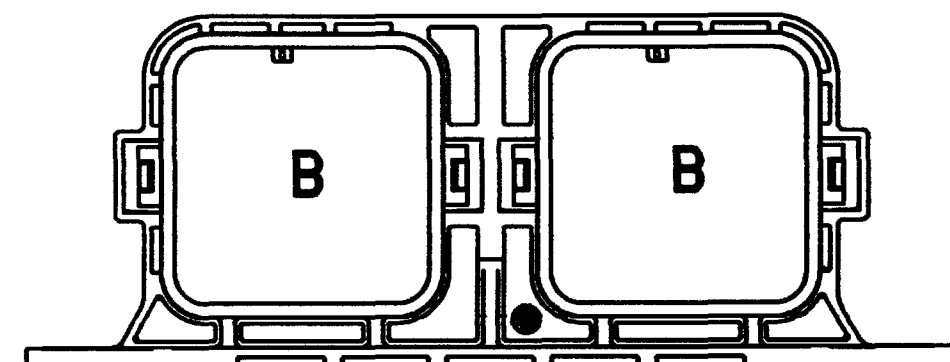

DRBF-3BB
KEYS B & B

NOTES:

SIGNATURE & DATE	
DR	S. PALLUTH 04/04/01
CHK	R. Sullivan 9-13-05
PE	Vladimir Tomca SEP-2-05
APPD	D. Meyer 9/6/05
SCALE	NONE DWT

FLANGE DUAL INTERFACE
KEYS: AA THRU DD
COLOR: BLACK
DRB SERIES

ENVELOPE

CP	EP063	MATL. CODE
The Deutch Company DEUTSCH I.P.D. 3850 INDUSTRIAL AVE. HEMET, CALIF. 92545		
B	DRBF-3**	
DWG SIZE	CODE 11139	SHEET 2 OF 4

REV
B DRBF-3**

REVISIONS			
SYM	DESCRIPTION	DATE	APPROVED
B	SEE SHEET 1	9-13-05	RDR

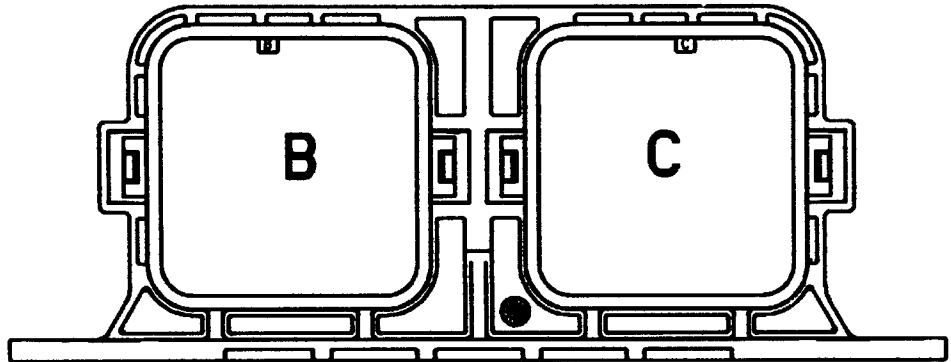

DRBF-3BC
KEYS B & C

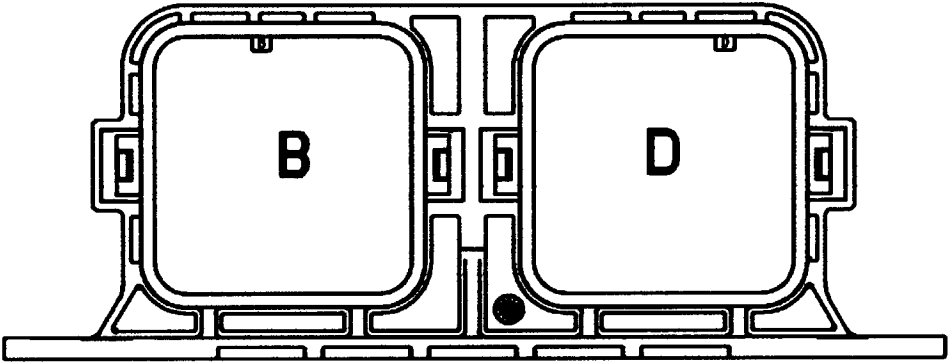

DRBF-3BD
KEYS B & D

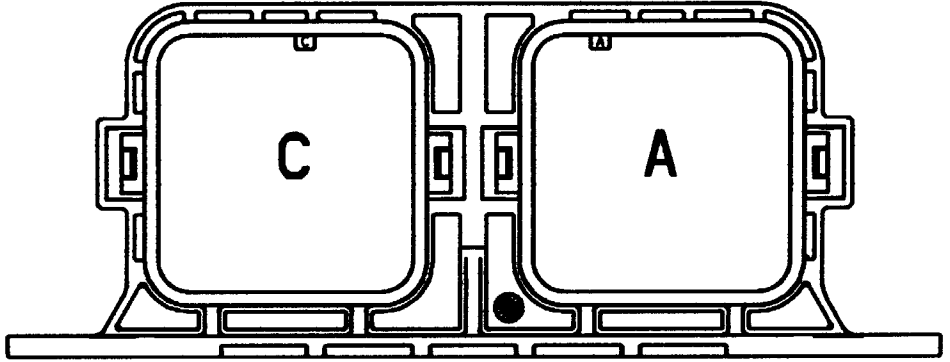

DRBF-3CA
KEYS C & A

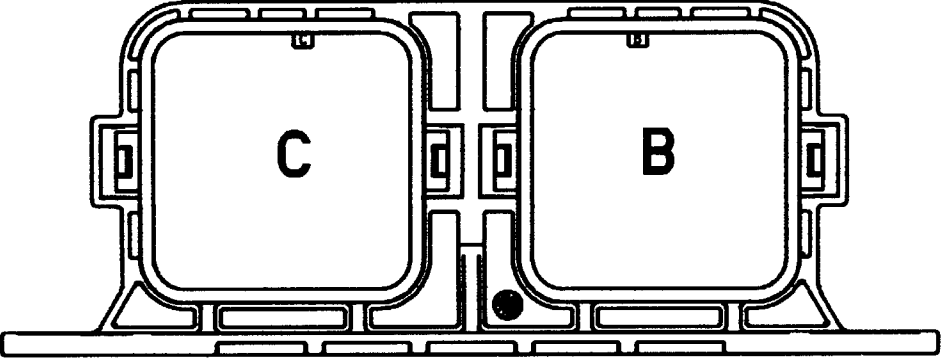

DRBF-3CB
KEYS C & B

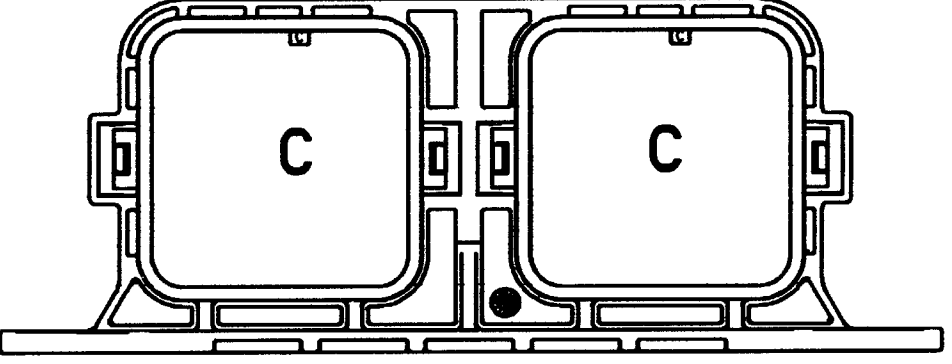

DRBF-3CC
KEYS C & C

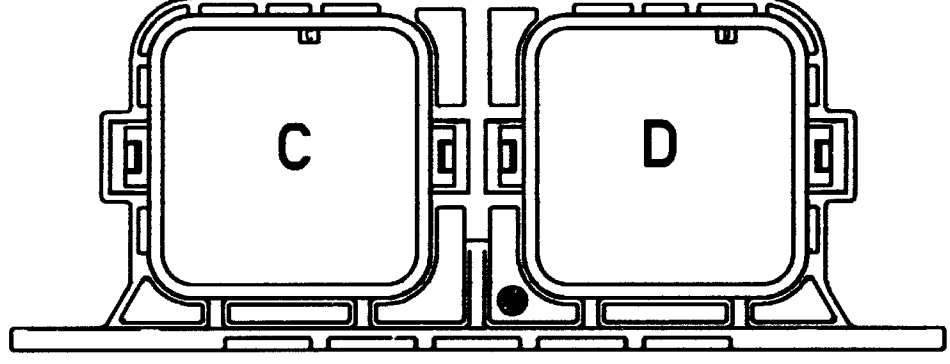

DRBF-3CD
KEYS C & D

NOTES:

SIGNATURE & DATE	
DR	S. PALLUTH 04/04/01
CHK	<i>R. Miller</i> 9-13-05
PE	<i>Radwin Tomse</i> SEP-2-05
APPD	<i>D. Messy</i> 9/16/05
SCALE	NONE

FLANGE DUAL INTERFACE
KEYS: AA THRU DD
COLOR: BLACK
DRB SERIES

ENVELOPE

CP	EP063	MATL. CODE
The Deutsch Company DEUTSCH I. P. D. 3850 INDUSTRIAL AVE. HEMET, CALIF. 92545		
B	DRBF-3**	
DWG SIZE	CODE 11139	SHEET 3 OF 4

REV	DRBF-3**	REVISIONS			
B		SYM	DESCRIPTION	DATE	APPROVED
		B	SEE SHEET 1	9-13-05	RDR

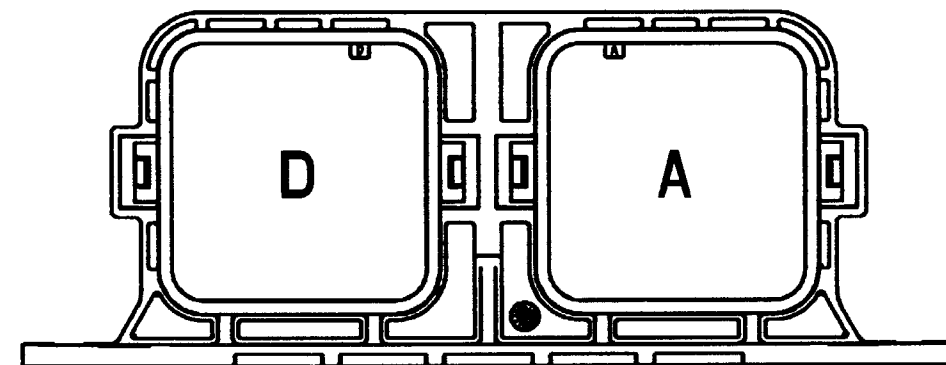

DRBF-3DA
KEYS D & A

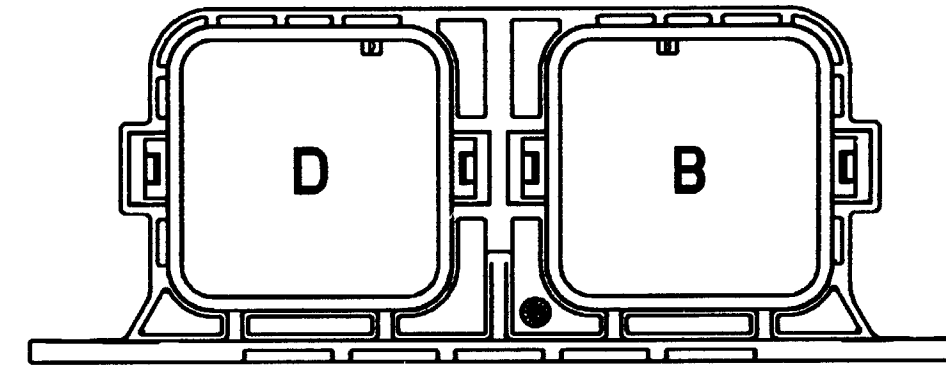

DRBF-3DB
KEYS D & B

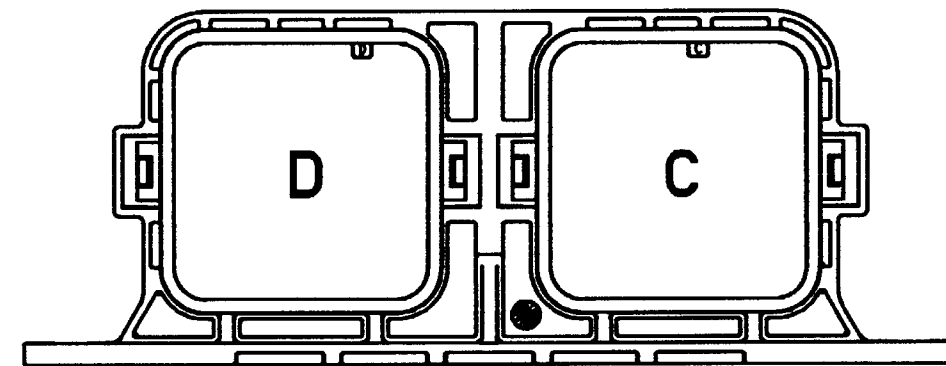

DRBF-3DC
KEYS D & C

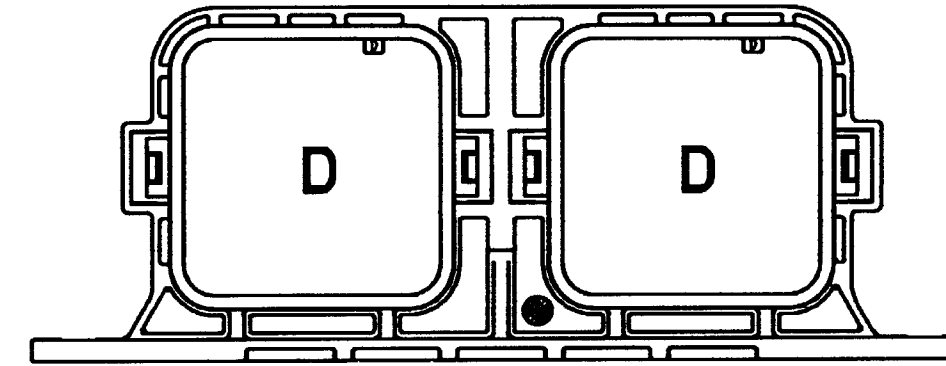

DRBF-3DD
KEYS D & D

NOTES:

SIGNATURE & DATE		FLANGE DUAL INTERFACE KEYS: AA THRU DD COLOR: BLACK DRB SERIES	CP	EP063	MATL. CODE
DR	S. PALLUTH 04/04/01		The Deutch Company		
CHK	R. Sullivan 9-13-05		DEUTSCH I.P.D. 3850 INDUSTRIAL AVE. HEMET, CALIF. 92545		
PE	Nadimir Tomor SEP 2-05		B DRBF-3**		
APPD	D. May 9/6/05	ENVELOPE	DWG SIZE	CODE 11139	SHEET 4 OF 4
SCALE	NONE				

X-ON Electronics

Largest Supplier of Electrical and Electronic Components

Click to view similar products for [Automotive Connectors](#) category:

Click to view products by [TE Connectivity](#) manufacturer:

Other Similar products are found below :

[003-018-000](#) [60403001](#) [60993906-B](#) [M902-2131](#) [M902-2161](#) [72.330.1035.1](#) [73.353.4028.0](#) [F119300-B](#) [F166900](#) [F258300-B](#) [F358300-B](#)
[F407400](#) [F444110](#) [F487000](#) [F509500B-B](#) [827153-1](#) [8N1515-32-24P](#) [9-1326729-8](#) [925474-1](#) [928905-1](#) [964562-4](#) [968782-1](#) [GT17SA-8DS-](#)
[HU](#) [98891-1012](#) [98947-1016](#) [12004147](#) [12004475-L](#) [12010290](#) [12010309-B](#) [12015454](#) [12020219-B](#) [12020308](#) [12041318-B](#) [12052225-L](#)
[12052466](#) [12059125](#) [12064869](#) [12004327-B](#) [12010503-B](#) [12015308](#) [12015384](#) [12015909](#) [1-21030-1](#) [12041254](#) [12041318](#) [12047946-B](#)
[12047957](#) [12047957-L](#) [12059473](#) [12066261](#)