

REVISIONS					
P	LTR	DESCRIPTION	DATE	DWN	APVD
	A1	REVISED PER PCN E-17-012564	28AUG2017	JA	DM

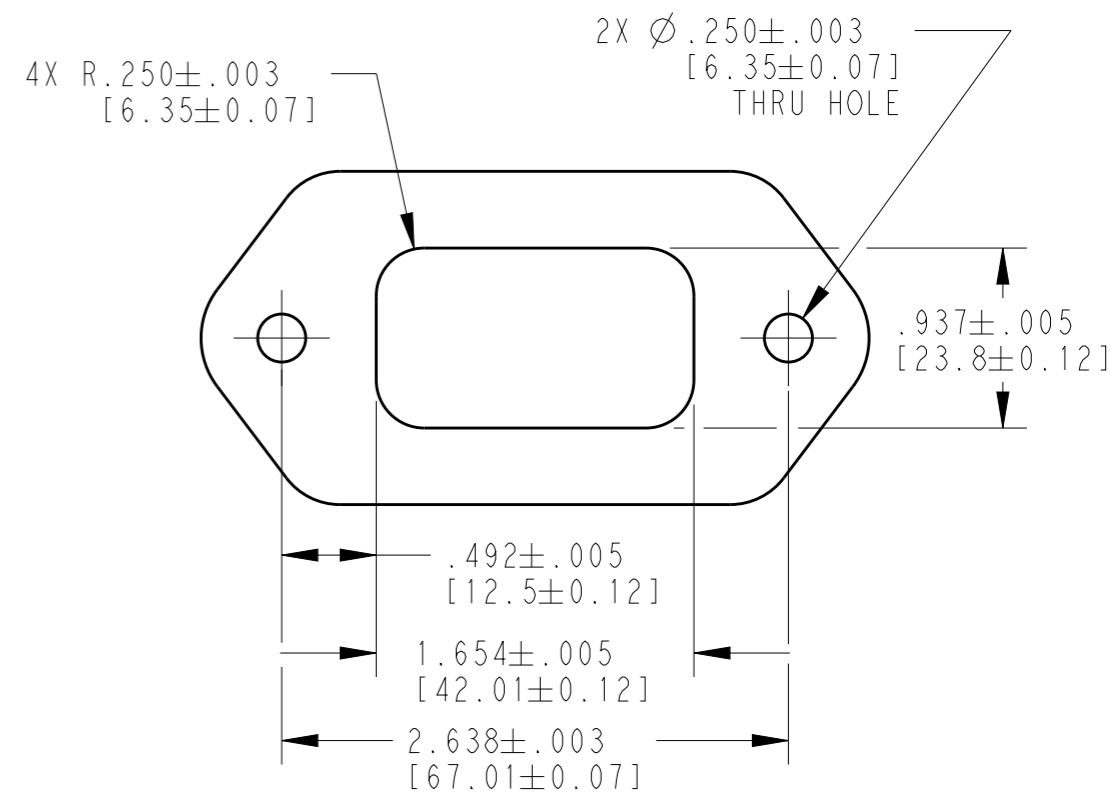
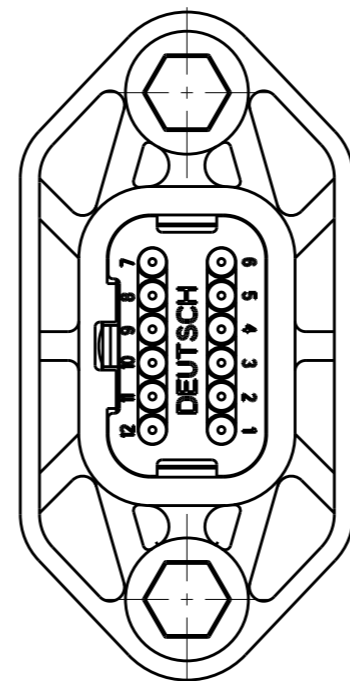
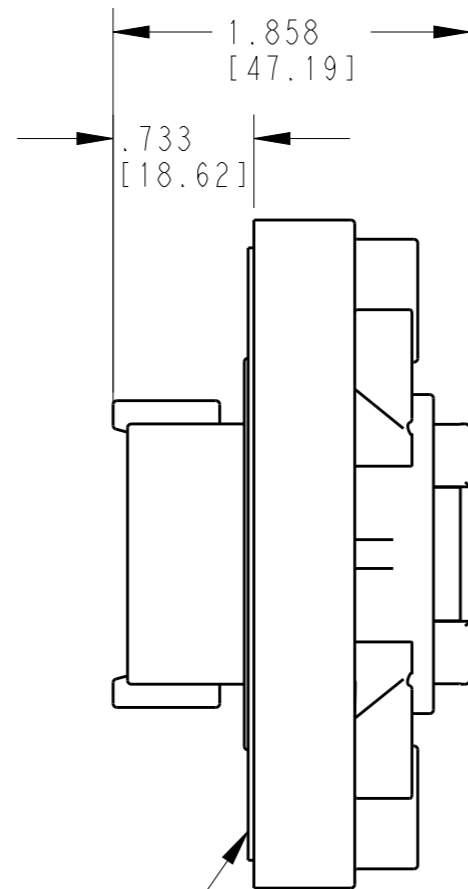
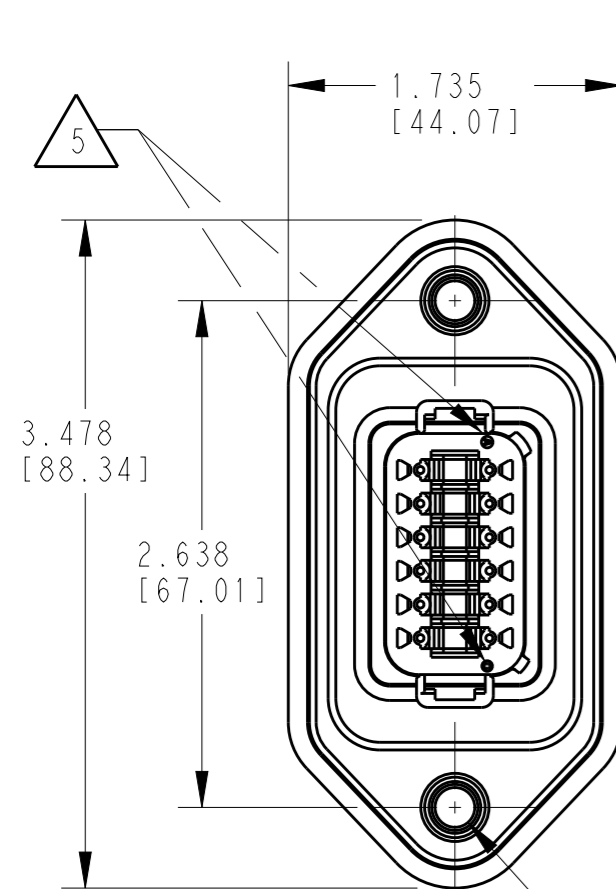

2X THREADED INSERT
M6 X .500 DEEP
RECOMMENDED TORQUE:
62-88 IN-LB [7-10 N-m]

FLANGE SEAL IS INTENDED
FOR NON-PRESSURIZED
FLUID SPLASH ONLY

**RECOMMENDED MOUNTING
DETAIL**

TE INTERNAL PN	DEUTSCH PN
DT04-12PA-LE01	DT04-12PA-LE01
DT04-12PB-LE01	DT04-12PB-LE01
DT04-12PC-LE01	DT04-12PC-LE01
DT04-12PD-LE01	DT04-12PD-LE01

CONTACT SIZE	MIN. INSUL O.D.	MAX. INSUL O.D.	WIRE RANGE [mm ²] REF ONLY
16	.088 [2.24]	.145 [3.68]	14-20 AWG [2.5-0.5]

- 5 DATE CODE: MONTH IS REPRESENTED BY SEQUENTIAL ALPHA CHARACTERS. EX: A = JANUARY, YEAR IS REPRESENTED BY LAST NUMERICAL DIGIT. EX: 0 = 2010
- 4. COLOR OF FLANGE IS BLACK FOR ALL KEY ARRANGEMENTS WHILE COLOR OF SHELL AND WELD CAP DEPENDS ON KEY ARR. AS SHOWN ON SHEET 2.
- 3 MATERIAL: HOUSING, CAP, FLANGE: PA66 GF15
GROMMET, GASKET: VMQ (RED-ORANGE)
INSERTS: STAINLESS STEEL

2. THIS RECEPTACLE MATES WITH DT06-12SX-XXXX PLUG.
(X = KEY ARR. A,B,C, OR D, XXXX = ALL MODIFICATIONS)
CONSULT FACTORY FOR MODIFICATIONS.

1 FOR CONTACTS AND WIRE PERFORMANCE AND APPLICATION CHARACTERISTICS, SEE ENVELOPE DRAWING 0425-015-0000.

NOTES: UNLESS OTHERWISE SPECIFIED

THIS DRAWING IS A CONTROLLED DOCUMENT.		DWN T. YOHANNES 18SEP2002		
DIMENSIONS: in [mm]		CHK R. MESSENGER 03MAY2005		
TOLERANCES UNLESS OTHERWISE SPECIFIED:		APVD S. BEARD 27APR2005	NAME 12 WAY RECEPTACLE DT SERIES	
0 PLC ±		PRODUCT SPEC 108-151009	SIZE A3	
1 PLC ±		APPLICATION SPEC 0425-017-0000	CAGE CODE 4AFU8	DRAWING NO. DT04-12PX-LE01
2 PLC ±		WEIGHT 80.88g	RESTRICTED TO -	
3 PLC ±.025 [0.64]		CUSTOMER DRAWING	SCALE 1:1	SHEET 1 OF 2
4 PLC ±			REV A1	
ANGLES ±0° 30' 0"				
MATERIAL	FINISH			

REVISIONS

P	LTR	DESCRIPTION	DATE	DWN	APVD
-		SEE SHEET 1	-	-	-

DT04-12PA-LE01
 KEY ARR. -A-
 COLOR : GRAY (SHELL AND WELD CAP)
 (FLANGE IS BLACK FOR ALL KEY ARR.)

DT04-12PB-LE01
 KEY ARR. -B-
 COLOR : BLACK (SHELL AND WELD CAP)

DT04-12PC-LE01
 KEY ARR. -C-
 COLOR : GREEN (SHELL AND WELD CAP)

DT04-12PD-LE01
 KEY ARR. -D-
 COLOR : BROWN (SHELL AND WELD CAP)

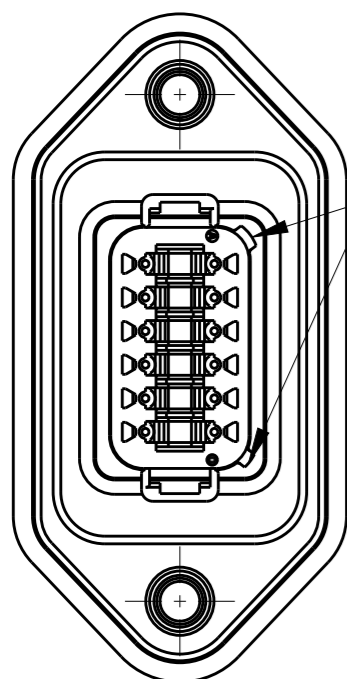

KEYWAYS -A-

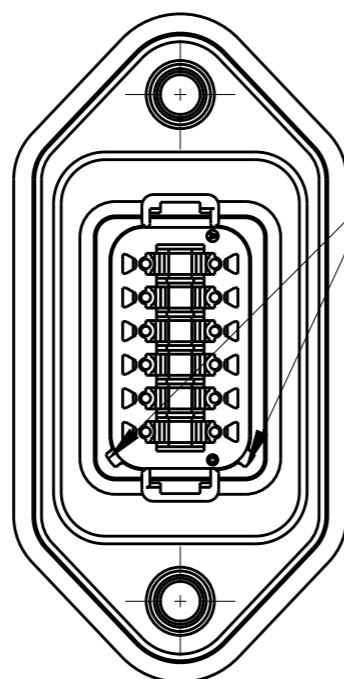

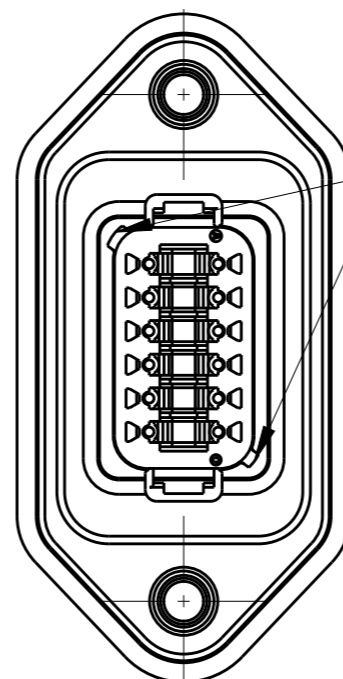

KEYWAYS -B-

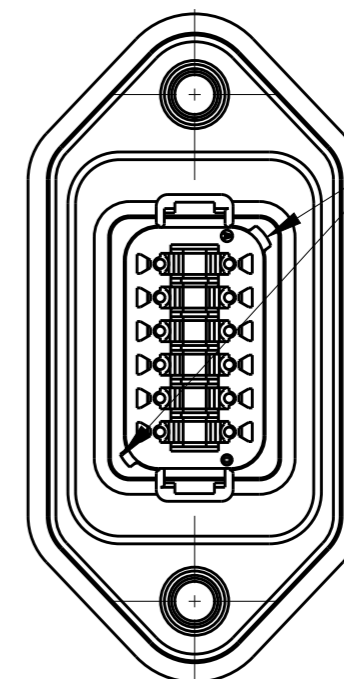

KEYWAYS -C-



KEYWAYS -D-

THIS DRAWING IS A CONTROLLED DOCUMENT.		DWN T. YOHANNES 18SEP2002	 TE Connectivity		
DIMENSIONS: in [mm]		CHK R. MESSENGER 03MAY2005			
TOLERANCES UNLESS OTHERWISE SPECIFIED:		APVD S. BEARD 27APR2005	NAME 12 WAY RECEPTACLE DT SERIES		
0 PLC ± 1 PLC ± 2 PLC ± 3 PLC ±.025 [0.64] 4 PLC ± ANGLES ±0° 30' 0"		PRODUCT SPEC 108-151009	RESTRICTED TO		
MATERIAL		APPLICATION SPEC 0425-017-0000	SIZE A3	CAGE CODE 4AFU8	DRAWING NO DT04-12PX-LE01
FINISH		WEIGHT 80.88g	SCALE 1:1		
		CUSTOMER DRAWING	SHEET 2 OF 2		
			REV A1		

X-ON Electronics

Largest Supplier of Electrical and Electronic Components

Click to view similar products for [Automotive Connectors](#) category:

Click to view products by [TE Connectivity](#) manufacturer:

Other Similar products are found below :

[003-018-000](#) [60403001](#) [60993906-B](#) [M902-2131](#) [M902-2161](#) [72.330.1035.1](#) [73.353.4028.0](#) [F119300-B](#) [F166900](#) [F258300-B](#) [F358300-B](#)
[F407400](#) [F444110](#) [F487000](#) [F509500B-B](#) [827153-1](#) [8N1515-32-24P](#) [9-1326729-8](#) [925474-1](#) [928905-1](#) [964562-4](#) [968782-1](#) [GT17SA-8DS-](#)
[HU](#) [98891-1012](#) [98947-1016](#) [12004147](#) [12004475-L](#) [12010290](#) [12010309-B](#) [12015454](#) [12020219-B](#) [12020308](#) [12041318-B](#) [12052225-L](#)
[12052466](#) [12059125](#) [12064869](#) [12004327-B](#) [12010503-B](#) [12015308](#) [12015384](#) [12015909](#) [1-21030-1](#) [12041254](#) [12041318](#) [12047946-B](#)
[12047957](#) [12047957-L](#) [12059473](#) [12066261](#)