

3D VIEW

REV  
NC DT06-12S\*-CE04

REVISIONS			
SYM	DESCRIPTION	DATE	APPROVED
NC	REDRAWN/REPLACES PREVIOUS		
	RELEASE PER E.O. P18157	5-16-03	RDR

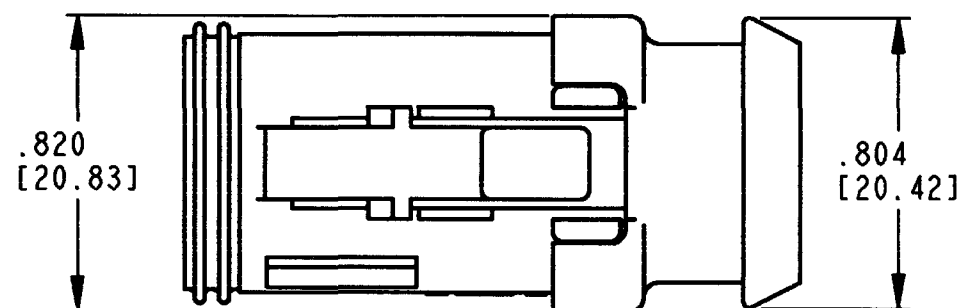

CONTACT SIZE	MIN. INSUL O.D.	MAX. INSUL O.D.	WIRE RANGE [mm <sup>2</sup> ] REF ONLY
16	.053 [1.35]	.120 [3.05]	14-20 AWG [2.0-0.5]

DATE CODE: MONTH IS REPRESENTED BY SEQUENTIAL ALPHA CHARACTERS. EX: A=JANUARY

DATE CODE: YEAR IS REPRESENTED BY THE LAST NUMERICAL DIGIT. EX: 0=2000.

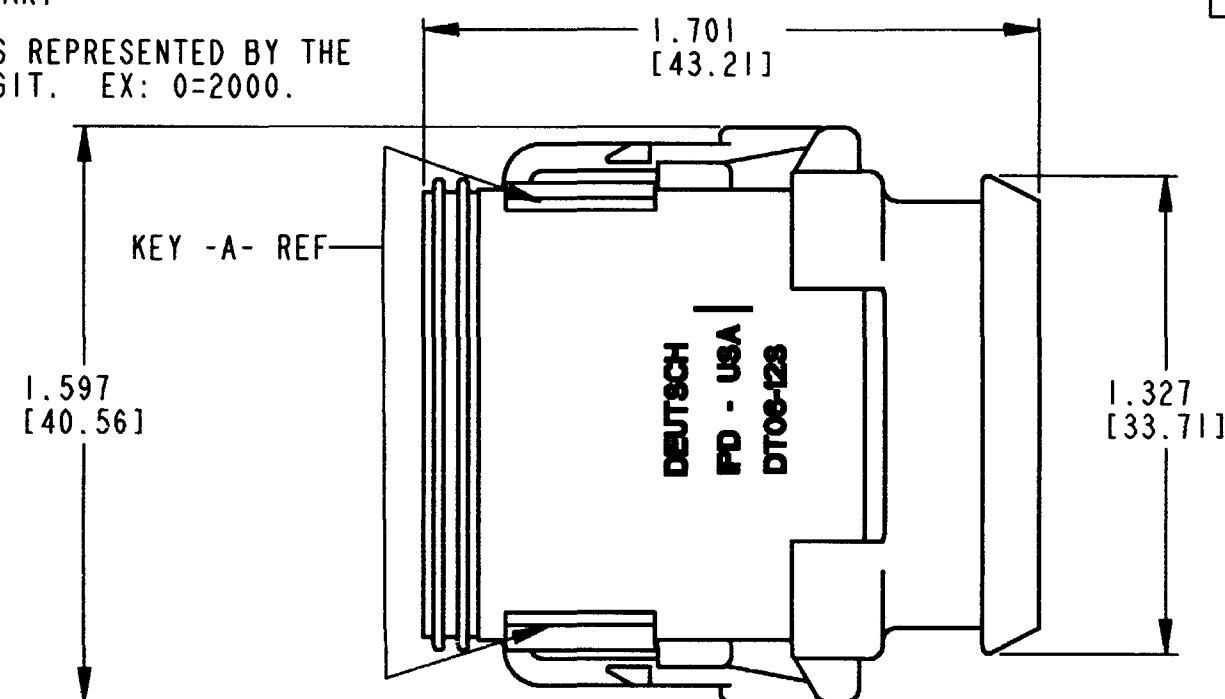
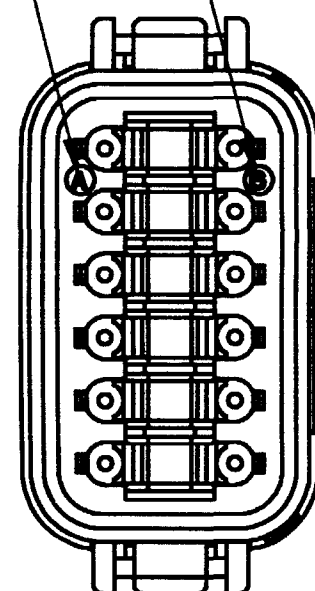

-E- DESIGNATES REDUCED DIAMETER WIRE SEAL

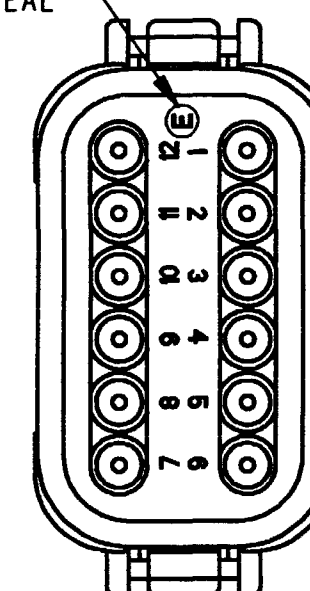

5. MATERIAL: SHELL: PLASTIC  
SEAL: RUBBER

4. THIS PLUG MATES WITH DT04-12PA-\*\*\*\* (\*\*\*\* = ALL MODIFICATIONS). CONSULT FACTORY FOR MODIFICATIONS.

3. FOR CONTACTS AND WIRE PERFORMANCE AND APPLICATION CHARACTERISTICS SEE ENVELOPE DRAWING 0425-015-0000 AND 0425-017-0000.

2. DIMENSIONS ARE ±.025[0.63] UNLESS OTHERWISE SPECIFIED.

1. DIMENSIONS ARE IN INCHES [MILLIMETERS].

NOTES:

SIGNATURE & DATE	
DR	T. YOHANNES 5/2/03
CHK	D. M... 5/15/03
PE	T. Johannes 5/16/03
APPD	S. Band 5-7-03
SCALE	NONE WT

12 WAY PLUG  
W/ EXTENDED WELD CAP  
AND REDUCED WIRE SEALS  
DT SERIES

ENVELOPE

CP	MATL. CODE
	<b>The Deutsch Company</b> DEUTSCH I. P. D. 3850 INDUSTRIAL AVE. HEMET, CALIF. 92545
<b>B</b>	<b>DT06-12S*-CE04</b>
DWG SIZE	CODE 11139 SHEET 1 OF 2

REV	DT06-12S*-CE04	REVISIONS		
SYM	DESCRIPTION	DATE	APPROVED	
NC	REDRAWN/REPLACES PREVIOUS			
	RELEASE PER E.O. P18157	5-16-03	ADR	

PART NO: DT06-12SA-CE04  
KEY ARR. -A-  
COLOR: GRAY

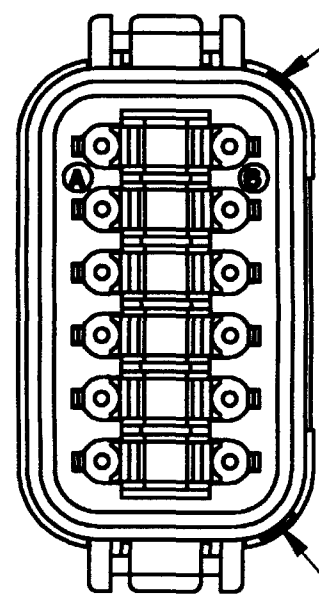

PART NO: DT06-12SB-CE04  
KEY ARR. -B-  
COLOR: BLACK

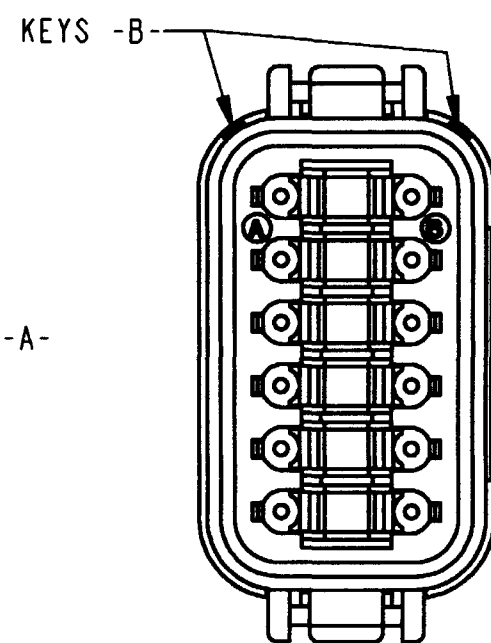

PART NO: DT06-12SC-CE04  
KEY ARR. -C-  
COLOR: GREEN

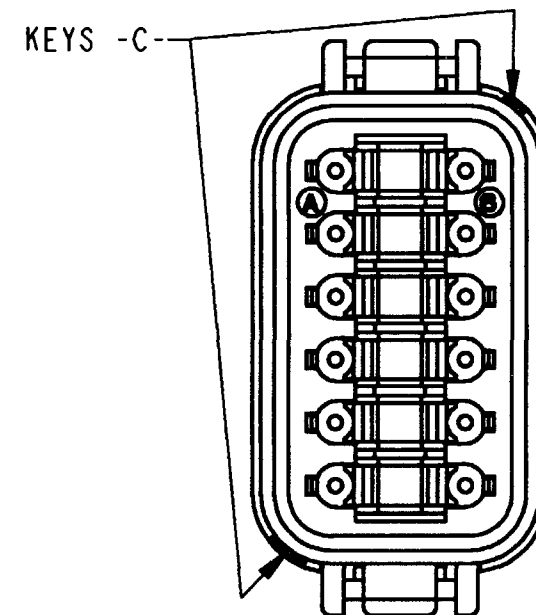

PART NO: DT06-12SD-CE04  
KEY ARR. -D-  
COLOR: BROWN

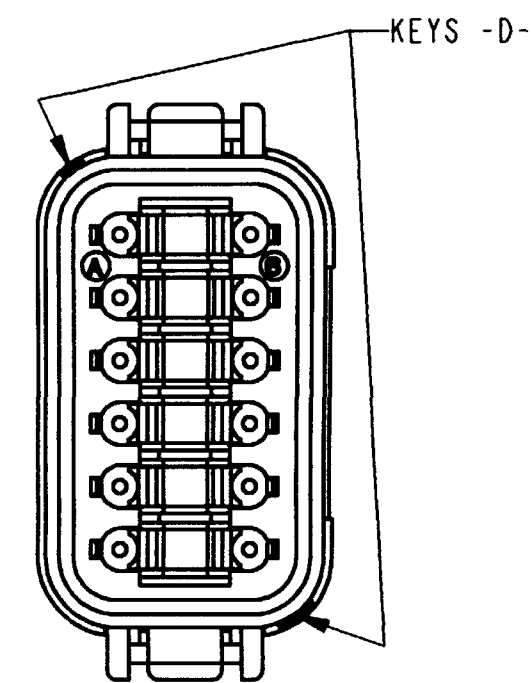

NOTES:

SIGNATURE & DATE		12 WAY PLUG W/ EXTENDED WELD CAP AND REDUCED WIRE SEALS DT SERIES	CP	MATL. CODE	
DR	T. YOHANNES 5/2/03		The Deutch Company DEUTSCH I. P. D. 3850 INDUSTRIAL AVE. HEMET, CALIF. 92545		
CHK	<i>D. Meyer</i> 5/15/03		<b>B</b>	DT06-12S*-CE04	
PE	<i>Tom Jones</i> 5/15/03			DWG SIZE	CODE 11139
APPD	<i>S. Brand</i> 5-7-03	ENVELOPE			
SCALE	NONE WT				

## X-ON Electronics

Largest Supplier of Electrical and Electronic Components

*Click to view similar products for [Automotive Connectors](#) category:*

*Click to view products by [TE Connectivity](#) manufacturer:*

Other Similar products are found below :

[003-018-000](#) [60403001](#) [60993906-B](#) [M902-2131](#) [M902-2161](#) [72.330.1035.1](#) [73.353.4028.0](#) [F119300-B](#) [F166900](#) [F258300-B](#) [F358300-B](#)  
[F407400](#) [F444110](#) [F487000](#) [F509500B-B](#) [827153-1](#) [8N1515-32-24P](#) [9-1326729-8](#) [925474-1](#) [928905-1](#) [964562-4](#) [968782-1](#) [GT17SA-8DS-](#)  
[HU](#) [98891-1012](#) [98947-1016](#) [12004147](#) [12004475-L](#) [12010290](#) [12010309-B](#) [12015454](#) [12020219-B](#) [12020308](#) [12041318-B](#) [12052225-L](#)  
[12052466](#) [12059125](#) [12064869](#) [12004327-B](#) [12010503-B](#) [12015308](#) [12015384](#) [12015909](#) [1-21030-1](#) [12041254](#) [12041318](#) [12047946-B](#)  
[12047957](#) [12047957-L](#) [12059473](#) [12066261](#)