

REV
NC DTM06-12S*-E003

REVISIONS			
SYM	DESCRIPTION	DATE	APPROVED
NC	NEW RELEASE PER E.O. P17535	12-17-01	RDR

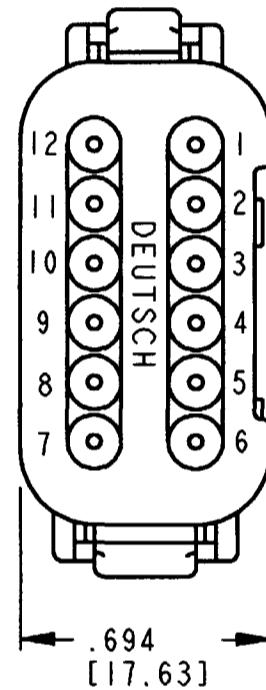

8
END CAP

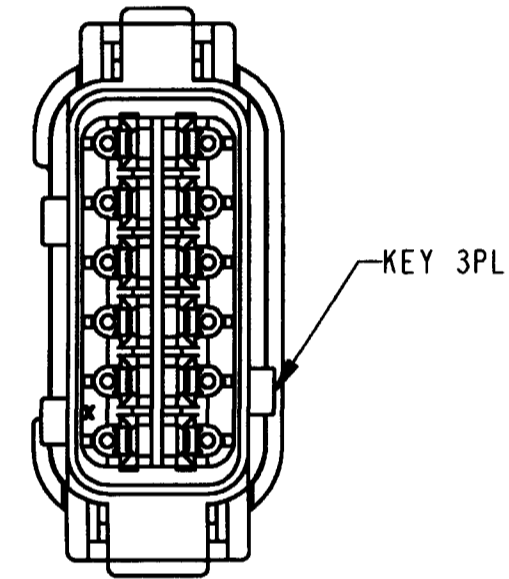
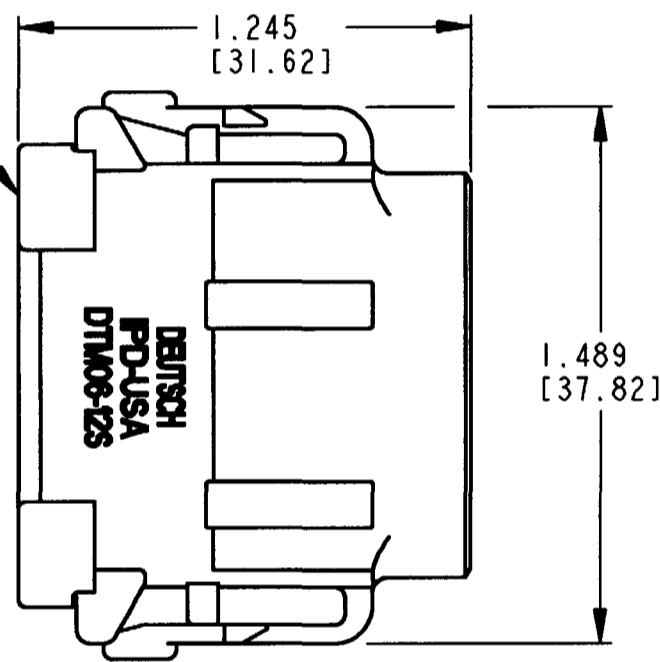

- 8. PART MODIFICATION.
 - 7. SEE SHEET 2 FOR OTHER KEY ARRANGEMENT.
 - 6. MATERIAL - HOUSING/END CAP: PLASTIC; GROMMET: RUBBER.
 - 5. THIS PLUG MATES WITH DTM04-12P*-**** RECEPTACLE. (* = A,B,C,D KEYS; **** = ALL MODIFICATIONS)
 - 4. FOR CONTACT AND WIRE PERFORMANCE AND APPLICATION CHARACTERISTICS SEE ENVELOPE DRAWING 0425-015-0000.
 - 3. SECONDARY WEDGE LOCK SOLD SEPARATELY: WM-12S.
 - 2. DIMENSION TOLERANCE: $\pm .025$ [.64].
 - 1. DIMENSIONS ARE IN INCHES [mm].
- NOTES: UNLESS OTHERWISE SPECIFIED

CONTACT SIZE	MIN. INSUL. O.D.	MAX. INSUL. O.D.	WIRE RANGE [mm ²] REF ONLY
20	.053 [1.35]	.120 [3.05]	16-20 AWG [1.0-0.5]

SIGNATURE & DATE	
DR	D. MEYER 11/15/01
CHK	B. B. 12/17/01
PE	D. Meyer 12/13/01
APPD	R. Reed 12-17-01
SCALE	NONE WT

PLUG W/END CAP
12 CONTACTS, SIZE 20
A,B,C,D KEYS
-E003 MOD
DTM SERIES

CP	MATL. CODE
The Deutsch Company DEUTSCH I.P.D. 3850 INDUSTRIAL AVE. HEMET, CALIF. 92545	
B DTM06-12S*-E003	
DWG SIZE	CODE 11139 SHEET 1 OF 2

ENVELOPE

REV NC	DTM06-12S*-E003	REVISIONS		
SYM	DESCRIPTION	DATE	APPROVED	
	SEE SHEET 1	12-17-01	ROR	

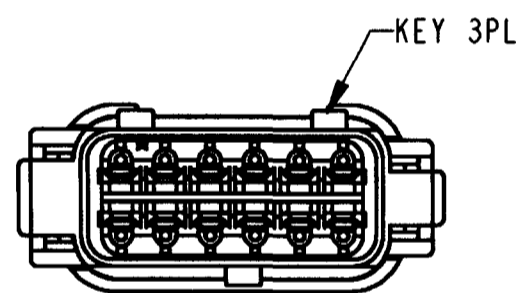
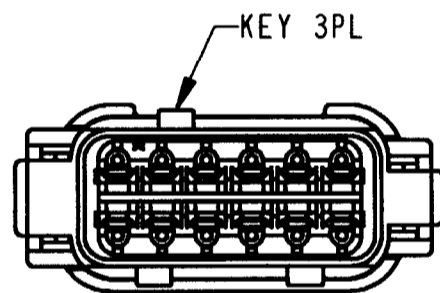
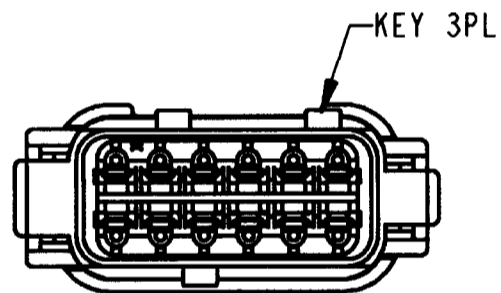
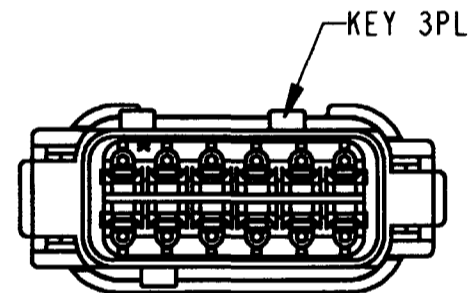
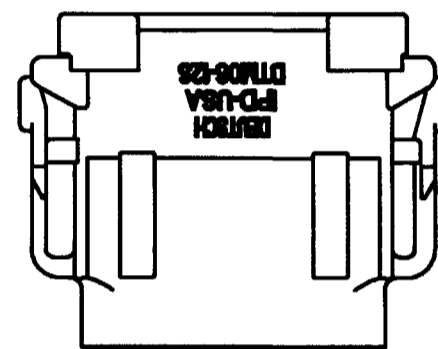
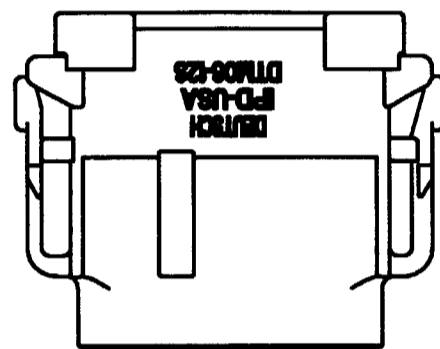
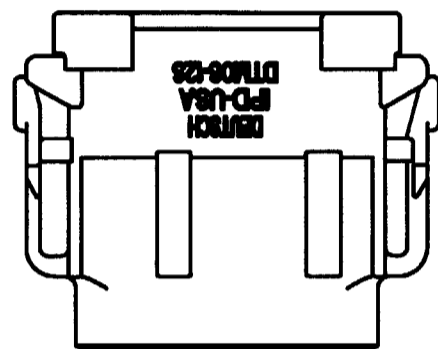
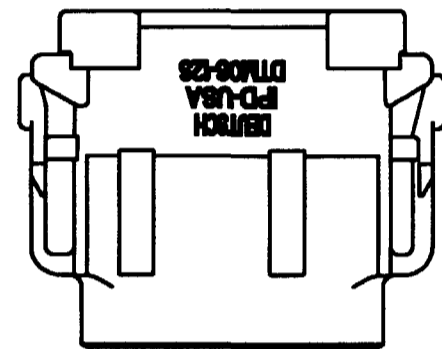

DTM06-12SA-E003
KEY -A-
COLOR: GREY

DTM06-12SB-E003
KEY -B-
COLOR: BLACK

DTM06-12SC-E003
KEY -C-
COLOR: GREEN

DTM06-12SD-E003
KEY -D-
COLOR: BROWN

NOTES:

SIGNATURE & DATE		PLUG W/END CAP 12 CONTACTS, SIZE 20 A,B,C,D KEYS -E003 MOD DTM SERIES	CP	MATL. CODE
DR	D. MEYER 11/15/01		The Deutsch Company DEUTSCH I.P.D. 3850 INDUSTRIAL AVE. HEMET, CALIF. 92545	
CHK	R. Reed 12/17/01		B DTM06-12S*-E003	
PE	D. Meyer 12/13/01			
APPD	R. Reed 12-17-01		DWG SIZE	CODE 11139
SCALE	NONE	WT		

ENVELOPE

X-ON Electronics

Largest Supplier of Electrical and Electronic Components

Click to view similar products for [Automotive Connectors](#) category:

Click to view products by [TE Connectivity](#) manufacturer:

Other Similar products are found below :

[003-018-000](#) [60403001](#) [60993906-B](#) [M902-2131](#) [M902-2161](#) [72.330.1035.1](#) [73.353.4028.0](#) [F119300-B](#) [F166900](#) [F258300-B](#) [F358300-B](#)
[F407400](#) [F444110](#) [F487000](#) [F509500B-B](#) [827153-1](#) [8N1515-32-24P](#) [9-1326729-8](#) [925474-1](#) [928905-1](#) [964562-4](#) [968782-1](#) [GT17SA-8DS-](#)
[HU](#) [98891-1012](#) [98947-1016](#) [12004147](#) [12004475-L](#) [12010290](#) [12010309-B](#) [12015454](#) [12020219-B](#) [12020308](#) [12041318-B](#) [12052225-L](#)
[12052466](#) [12059125](#) [12064869](#) [12004327-B](#) [12010503-B](#) [12015308](#) [12015384](#) [12015909](#) [1-21030-1](#) [12041254](#) [12041318](#) [12047946-B](#)
[12047957](#) [12047957-L](#) [12059473](#) [12066261](#)