

CONTACT SIZE	MIN. INSUL. O.D.	MAX. INSUL. O.D.	WIRE RANGE [mm <sup>2</sup> ] REF ONLY
16	.088 [2.23]	.145 [3.68]	14-20 AWG [2.0-0.5]

REV NC **DTV06-18S\***

REVISIONS			
SYM	DESCRIPTION	DATE	APPROVED
NC	NEW RELEASE PER E.O. P17202	3-29-01	RJR

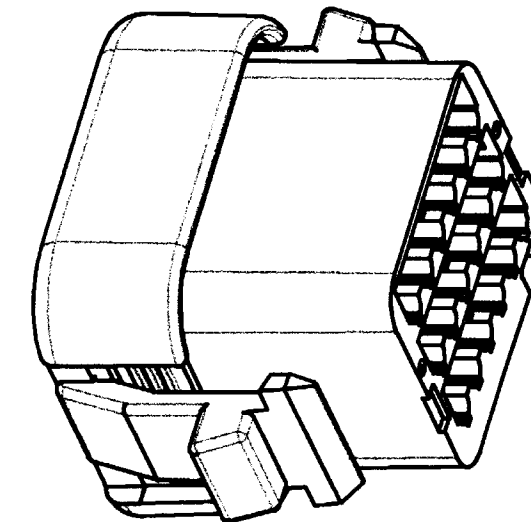
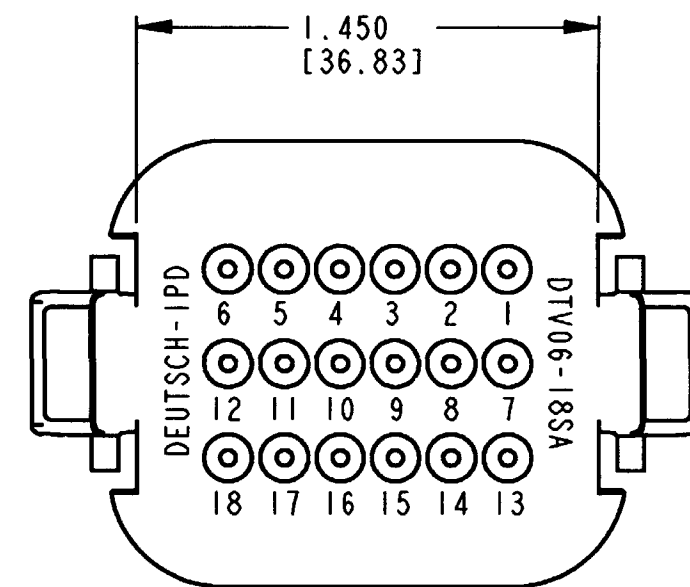
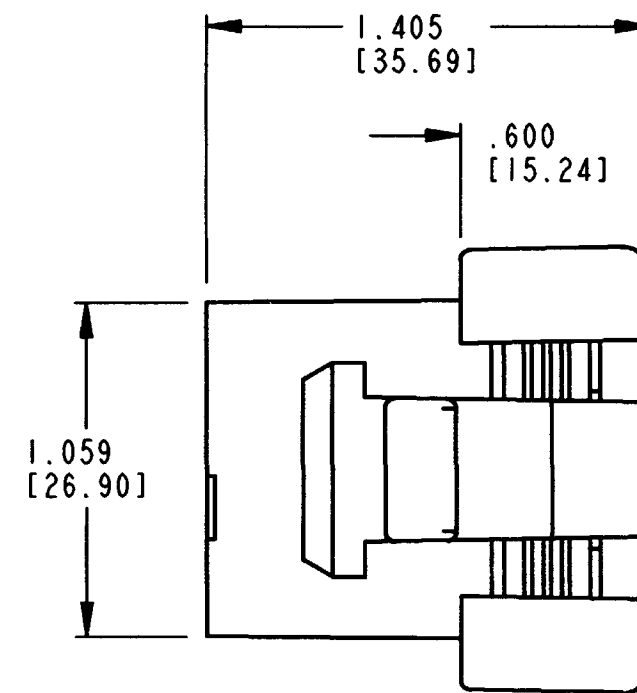

- 6. MATERIAL: HOUSING: PLASTIC; GROMMET: RUBBER.
  - 5. THIS PLUG MATES WITH DTV02-18P\*-\*\*\*\* RECEPTACLE. (\* = A,B,C,D KEYS; \*\*\*\* = ALL MODIFICATIONS.) CONSULT FACTORY FOR MODS.
  - 4. FOR CONTACT AND WIRE PERFORMANCE AND APPLICATION CHARACTERISTICS, SEE ENVELOPE DRAWINGS 0425-015-0000.
  - 3. ITEMS SOLD SEPARATELY: SECONDARY WEDGE LOCK WV-18S
  - 2. DIMENSION TOLERANCE: ±.025 [0.64]
  - 1. ALL DIMENSIONS ARE INCHES [mm].
- NOTES: UNLESS OTHERWISE SPECIFIED

8. DATE CODE: MONTH IS REPRESENTED BY SEQUENTIAL ALPHA CHARACTERS. EX: A = JANUARY; YEAR IS REPRESENTED BY LAST NUMERICAL DIGIT. EX: 9 = 2009

7. SEE SHEET 2 FOR OTHER KEY ARRANGEMENTS.

SIGNATURE & DATE		<b>PLUG</b> <b>18 CONTACTS, SIZE 16</b> <b>KEYS A,B,C &amp; D</b> <b>DTV SERIES</b>	CP 072	MATL. CODE
DR	S. PALLUTH 03/21/01		<b>The Deutsch Company</b> DEUTSCH I.P.D. 3850 INDUSTRIAL AVE. HEMET, CALIF. 92545	
CHK	J.C. [Signature] 3/26/01		<b>B DTV06-18S*</b> DWG SIZE CODE 11139 SHEET 1 OF 2	
PE	S. Palluth 3/22/01			
APPD	[Signature] 3/22/01	ENVELOPE		
SCALE	NONE [W]			

REV NC	DTV06-18S*	REVISIONS			
		SYM	DESCRIPTION	DATE	APPROVED
			SEE SHEET 1	3-29-01	RDR

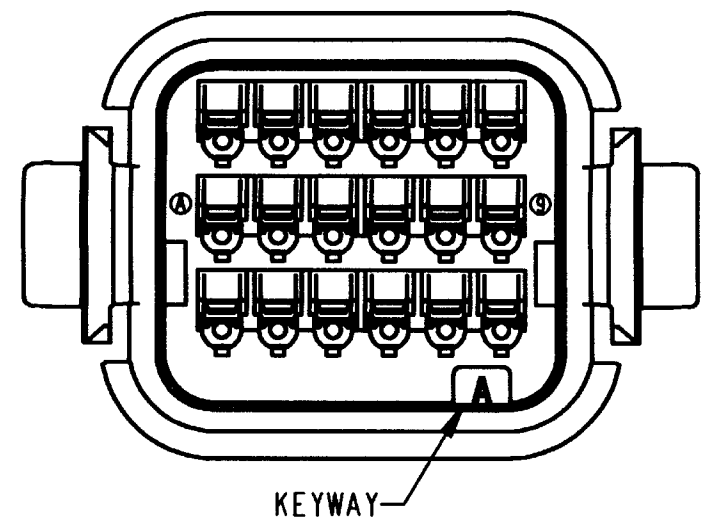

**DTV06-18SA**  
KEY ARRANGEMENT -A-  
COLOR: GREY

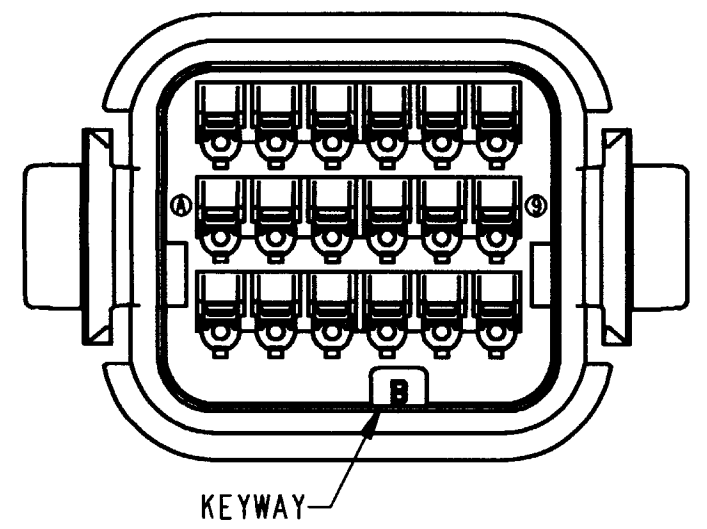

**DTV06-18SB**  
KEY ARRANGEMENT -B-  
COLOR: BLACK

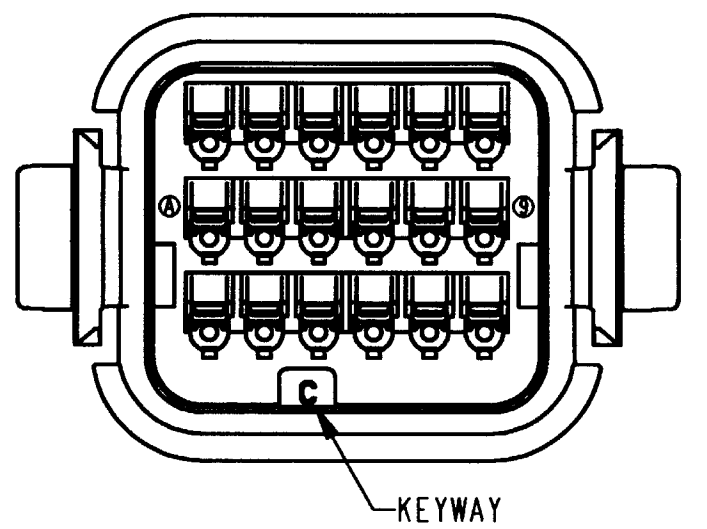

**DTV06-18SC**  
KEY ARRANGEMENT -C-  
COLOR: GREEN

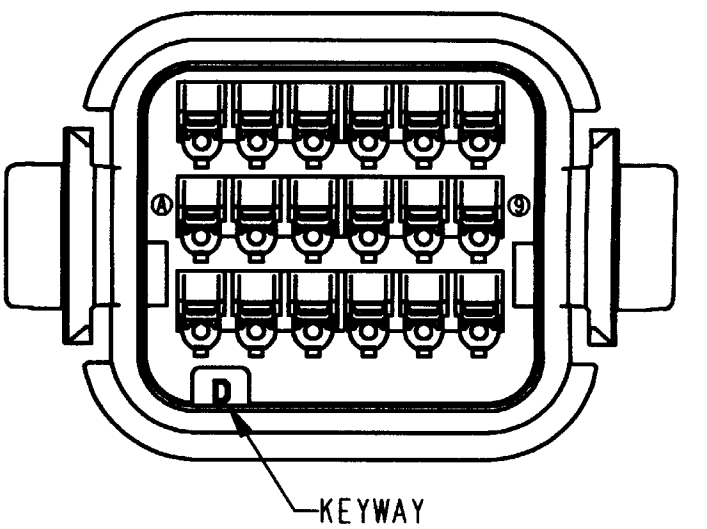

**DTV06-18SD**  
KEY ARRANGEMENT -D-  
COLOR: BROWN

NOTES:

SIGNATURE & DATE		PLUG 18 CONTACTS, SIZE 16 KEYS A, B, C & D DTV SERIES	CP 072	MATL. CODE	
DR	S. PALLUTH 03/21/01		<b>The Deutch Company</b> DEUTSCH I. P. D. 3850 INDUSTRIAL AVE. HEMET, CALIF. 92545		
CHK	<i>[Signature]</i> 3/26/01		<b>B</b>	<b>DTV06-18S*</b>	
PE	<i>[Signature]</i> 3/21/01			DWG SIZE	CODE 11139
APPD	<i>[Signature]</i> 3/22/01	ENVELOPE			
SCALE	NONE				

## X-ON Electronics

Largest Supplier of Electrical and Electronic Components

*Click to view similar products for [Automotive Connectors](#) category:*

*Click to view products by [TE Connectivity](#) manufacturer:*

Other Similar products are found below :

[003-018-000](#) [60403001](#) [60993906-B](#) [M902-2131](#) [M902-2161](#) [72.330.1035.1](#) [73.353.4028.0](#) [F119300-B](#) [F166900](#) [F258300-B](#) [F358300-B](#)  
[F407400](#) [F444110](#) [F487000](#) [F509500B-B](#) [827153-1](#) [8N1515-32-24P](#) [9-1326729-8](#) [925474-1](#) [928905-1](#) [964562-4](#) [968782-1](#) [GT17SA-8DS-](#)  
[HU](#) [98891-1012](#) [98947-1016](#) [12004147](#) [12004475-L](#) [12010290](#) [12010309-B](#) [12015454](#) [12020219-B](#) [12020308](#) [12041318-B](#) [12052225-L](#)  
[12052466](#) [12059125](#) [12064869](#) [12004327-B](#) [12010503-B](#) [12015308](#) [12015384](#) [12015909](#) [1-21030-1](#) [12041254](#) [12041318](#) [12047946-B](#)  
[12047957](#) [12047957-L](#) [12059473](#) [12066261](#)