



## CABLE GLANDS

Standard, specialized cable glands, plates and accessories for industrial applications



---

# Contents

Overview .....	p. 4
Offering.....	p. 5

## Standard cable glands

Polyamide with & without nut.....	p. 6
Brass with & without nut.....	p. 10
Snap-In Polyamide & Brass .....	p. 14

## Specialized cable glands

RJ45 Polyamide & Brass.....	p. 16
EMC Cable Glands .....	p. 18
EMC2 & EMC4.....	p. 18
Railway.....	p. 21
Hygienic.....	p. 22
Cable Glands: Standard & EMC.....	p. 22
Conduit Fittings.....	p. 24
Cable Entry Plates .....	p. 26
Ventilation Plugs.....	p. 28
Drain Plugs.....	p. 31
Round Plugs Polyamide & Metal .....	p. 32

## Accessories

Dome Plugs .....	p. 34
Locknuts.....	p. 36
Washer Gaskets .....	p. 38

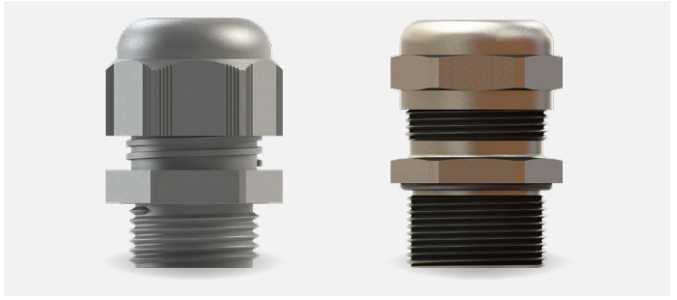

## A ROBUST HIGH-QUALITY PORTFOLIO FOR ENCLOSURE ENTRY IN STANDARD AND HARSH INDUSTRIAL ENVIRONMENTS

The ENTRELEC Electrical solutions industrial cable glands provide excellent strain relief for cables and high ingress protection against dirt, dust, water and other liquids for electrical enclosures. Portfolio includes plastic and metal cable glands and appropriate accessories for both standard and specialized applications.

### Reliable in harsh environments

#### High ingress protection ratings

IP68 and IP66 offer high protection against dirt, dust, sand, water, projections and other liquids with IP68 and IP66 ratings.

#### EMC protection & Vibration proof

EMC and railway metal cable glands are fitted with contact springs that enlarge contact with the cable shield ensuring long-lasting contact quality and vibration-proof connection.

#### Hygienic and low contamination areas

Hygienic cable glands and fittings are designed with high quality stainless steel to prevent harmful microorganisms from adhering to the surface and allow products to be suitable for high-pressure steam cleaning.

### Flexible to use

#### Many mounting options

- 3 types of thread specs: Metric, PG and NPT
- Time-saving option with snap-in products
- Locknuts included with a majority of standard glands

#### Various product functions to fit many applications

- Cable glands for single cable entry
- Cable plates for economical multiple cable entry
- Ventilation plugs to prevent humidity
- Drain plugs to drain water inside a cabinet
- EMC glands to protect cables against industrial noise
- RJ45 glands for data cables
- Fittings for conduits entry
- Dome and round plugs to close open holes

#### Various material and color options

- 3 plastic colors: light gray, gray and black
- Nickel plated brass available for most products
- Stainless steel available for select products

### For virtually all your needs

#### Standard industrial applications

Standard plastic & brass glands for electrical cabinets, plastic and metal boxes, LV/MV/HV panels, machine tools, motors, HVAC, compressors and more.

#### Industrial applications with harsh environments

- Brass EMC glands for environments with vibrations including elevators, HVAC, compressors, motors, railway and more.
- Hygienic glands for environments with potential contamination including food & pharmaceuticals, manufacturing & packaging, clean room technology, biotechnology, chemical industries and more.

#### A range adapted to your needs

- Economical: cable plates or plastic glands
- Durable: Brass and stainless steel glands
- High-performance : EMC brass and hygienic stainless steel glands

# Cable Glands

Offering

## Standard Cable Glands

With Thread				Snap-in	
Without Locknut 1SNG601....	With Locknut 1SNG626....	without Locknut 1SNG602....	With Locknut 1SNG625....	1SNG622.... Polyamide	1SNG623.... Brass
Polyamide				Brass	

## Specialized Cable Glands

RJ45		EMC			Hygienic		
1SNG618... Polyamide	1SNG619.... Brass	EMC2 1SNG613....	EMC4 1SNG614....	Railway 1SNG606....	With Thread 1SNG615....	EMC, with Thread 1SNG617...	Conduit fittings 1SNG616...
		Brass			Stainless steel 303		

## Plugs & Plates

Ventilation Plugs		Drain Plugs		Round Plugs		Cable Entry Plates	
1SNG605... Polyamide	1SNG624... Metal	1SNG611... Polyamide	1SNG612... Metal	1SNG620... Polyamide	1SNG621... Brass	For connectorised and non-connectorised cables 1SNG604.. Reinforced fiber	For non-connectorised cables 1SNG603... Reinforced fiber

## Accessories

Locknuts		Washer Gaskets		Dome Plugs
Flanged 1SNG607... Polyamide	1SNG608... Brass	1SNG609... CR	1SNG609... MBR	1SNG610... Polyamide



# Cable Glands

Standard Cable Glands, Polyamide with Threads, without Locknut



## Polyamide cable glands with lamellar clamping

- For standard industrial applications
- Material: Body, Cap: PA 6 / Seal: CR
- Ingress Protection Rating: IP 68 - 5 Bar, 30 min / IP 66
- UL Environmental Rating: TYPE 1, 4X acc. to UL 50E
- Flammability: V2 according to UL94
- Operating temperature:
  - Permanent: -20 °C to +100 °C
  - Intermittent: -30 °C to +150 °C
- Cable type: Non armoured
- Accessories (refers to dedicated page): Locknuts, Washer Gaskets, Dome Plugs

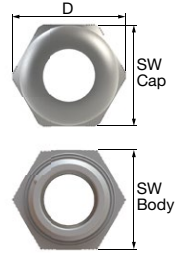
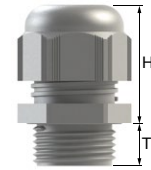

### Thread Type METRIC acc. to EN 60423

Outer Thread Size (Male)	Clamping Range Ø min - max	Outer Thread Length TL	Spanner Width		Outer Ø		Max. Height	Light grey RAL 7035		Grey RAL 7001		Black RAL 9005		Pkg per Box		
			Cap SW	Body SW	D	H		Description	Part Number	Description	Part Number	Description	Part Number			
M12x1.5	2-5 0.079-0.197	8 15	0.315	0.591	15	17	25.3	EP-SG-M12-LGR-A	1SNG601001R0000	EP-SG-M12-GR-A	1SNG601002R0000	EP-SG-M12-BL-A	1SNG601003R0000	100		
			0.394	0.591	0.669	0.996	EP-SG-M12-LGR-B	1SNG601004R0000	EP-SG-M12-GR-B	1SNG601005R0000	EP-SG-M12-BL-B	1SNG601006R0000	100			
			0.591	0.591	EP-SG-M12-LGR-C	1SNG601007R0000	EP-SG-M12-GR-C	1SNG601008R0000	EP-SG-M12-BL-C	1SNG601009R0000	100					
	3-6.5 0.118-0.02	8 15	0.315	0.591	15	17	25.3	EP-SG-M12-LGR-D	1SNG601010R0000	EP-SG-M12-GR-D	1SNG601011R0000	EP-SG-M12-BL-D	1SNG601012R0000	100		
			0.394	0.591	0.669	0.996	EP-SG-M12-LGR-E	1SNG601013R0000	EP-SG-M12-GR-E	1SNG601014R0000	EP-SG-M12-BL-E	1SNG601015R0000	100			
			0.591	0.591	EP-SG-M12-LGR-F	1SNG601016R0000	EP-SG-M12-GR-F	1SNG601017R0000	EP-SG-M12-BL-F	1SNG601018R0000	100					
M16x1.5	2-6 0.079-0.236	8 15	0.315	0.748	19	19	21.7	27.4	EP-SG-M16-LGR-A	1SNG601019R0000	EP-SG-M16-GR-A	1SNG601020R0000	EP-SG-M16-BL-A	1SNG601021R0000	50	
			0.394	0.748	0.854	1.079	EP-SG-M16-LGR-B	1SNG601022R0000	EP-SG-M16-GR-B	1SNG601023R0000	EP-SG-M16-BL-B	1SNG601024R0000	50			
			0.591	0.748	EP-SG-M16-LGR-C	1SNG601025R0000	EP-SG-M16-GR-C	1SNG601026R0000	EP-SG-M16-BL-C	1SNG601027R0000	50					
	3-7 0.118-0.276	10 15	0.394	0.866	22	25	32.2	1.268	EP-SG-M16-LGR-D	1SNG601028R0000	EP-SG-M16-GR-D	1SNG601029R0000	EP-SG-M16-BL-D	1SNG601030R0000	50	
			0.591	0.866	0.984	1.268	EP-SG-M16-LGR-E	1SNG601031R0000	EP-SG-M16-GR-E	1SNG601032R0000	EP-SG-M16-BL-E	1SNG601033R0000	50			
			0.866	0.866	EP-SG-M16-LGR-F	1SNG601034R0000	EP-SG-M16-GR-F	1SNG601035R0000	EP-SG-M16-BL-F	1SNG601036R0000	50					
	4-8 0.157-0.315	8 15	0.315	0.748	19	19	21.7	27.4	EP-SG-M16-LGR-G	1SNG601037R0000	EP-SG-M16-GR-G	1SNG601038R0000	EP-SG-M16-BL-G	1SNG601039R0000	50	
			0.394	0.748	0.854	1.079	EP-SG-M16-LGR-H	1SNG601040R0000	EP-SG-M16-GR-H	1SNG601041R0000	EP-SG-M16-BL-H	1SNG601042R0000	50			
			0.591	0.748	EP-SG-M16-LGR-I	1SNG601043R0000	EP-SG-M16-GR-I	1SNG601044R0000	EP-SG-M16-BL-I	1SNG601045R0000	50					
	5-10 0.197-0.394	10 15	0.394	0.866	22	25	32.2	1.268	EP-SG-M16-LGR-J	1SNG601046R0000	EP-SG-M16-GR-J	1SNG601047R0000	EP-SG-M16-BL-J	1SNG601048R0000	50	
			0.591	0.866	0.984	1.339	EP-SG-M20-LGR-A	1SNG601049R0000	EP-SG-M20-GR-A	1SNG601050R0000	EP-SG-M20-BL-A	1SNG601051R0000	50			
			0.866	0.866	EP-SG-M20-LGR-B	1SNG601052R0000	EP-SG-M20-GR-B	1SNG601053R0000	EP-SG-M20-BL-B	1SNG601054R0000	50					
M20x1.5	6-12 0.236-0.472	10 15	0.394	0.945	24	27	32.4	1.276	EP-SG-M20-LGR-C	1SNG601055R0000	EP-SG-M20-GR-C	1SNG601056R0000	EP-SG-M20-BL-C	1SNG601057R0000	50	
			0.591	0.945	1.063	1.276	EP-SG-M20-LGR-D	1SNG601058R0000	EP-SG-M20-GR-D	1SNG601059R0000	EP-SG-M20-BL-D	1SNG601060R0000	50			
			0.945	0.945	EP-SG-M20-LGR-E	1SNG601061R0000	EP-SG-M20-GR-E	1SNG601062R0000	EP-SG-M20-BL-E	1SNG601063R0000	50					
	7-12 0.276-0.472	10 15	0.394	1.063	27	30.9	31.9	1.256	EP-SG-M20-LGR-F	1SNG601064R0000	EP-SG-M20-GR-F	1SNG601065R0000	EP-SG-M20-BL-F	1SNG601066R0000	50	
			0.591	1.063	1.217	1.256	EP-SG-M20-LGR-G	1SNG601067R0000	EP-SG-M20-GR-G	1SNG601068R0000	EP-SG-M20-BL-G	1SNG601069R0000	50			
			1.063	1.063	EP-SG-M20-LGR-H	1SNG601070R0000	EP-SG-M20-GR-H	1SNG601071R0000	EP-SG-M20-BL-H	1SNG601072R0000	50					
	10-14 0.394-0.551	10 15	0.394	1.063	27	30.9	31.9	1.256	EP-SG-M20-LGR-I	1SNG601073R0000	EP-SG-M20-GR-I	1SNG601074R0000	EP-SG-M20-BL-I	1SNG601075R0000	50	
			0.591	1.063	1.217	1.256	EP-SG-M25-LGR-A	1SNG601076R0000	EP-SG-M25-GR-A	1SNG601077R0000	EP-SG-M25-BL-A	1SNG601078R0000	50			
			1.063	1.063	EP-SG-M25-LGR-B	1SNG601079R0000	EP-SG-M25-GR-B	1SNG601080R0000	EP-SG-M25-BL-B	1SNG601081R0000	40					
	M25x1.5	9-13 0.354-0.512	8 15	0.315	1.142	29	32.5	37.7	1.484	EP-SG-M25-LGR-C	1SNG601082R0000	EP-SG-M25-GR-C	1SNG601083R0000	EP-SG-M25-BL-C	1SNG601084R0000	25
				0.591	1.142	1.280	1.484	EP-SG-M25-LGR-D	1SNG601085R0000	EP-SG-M25-GR-D	1SNG601086R0000	EP-SG-M25-BL-D	1SNG601087R0000	25		
				1.142	1.142	EP-SG-M25-LGR-E	1SNG601088R0000	EP-SG-M25-GR-E	1SNG601089R0000	EP-SG-M25-BL-E	1SNG601090R0000	50				
11-17 0.433-0.669		8 15	0.315	1.142	29	32.5	37.7	1.484	EP-SG-M25-LGR-F	1SNG601091R0000	EP-SG-M25-GR-F	1SNG601092R0000	EP-SG-M25-BL-F	1SNG601093R0000	40	
			0.591	1.142	1.280	1.484	EP-SG-M25-LGR-G	1SNG601094R0000	EP-SG-M25-GR-G	1SNG601095R0000	EP-SG-M25-BL-G	1SNG601096R0000	25			
			1.142	1.142	EP-SG-M25-LGR-H	1SNG601097R0000	EP-SG-M25-GR-H	1SNG601098R0000	EP-SG-M25-BL-H	1SNG601099R0000	25					
M32x1.5	11-15 0.433-0.591	10 15	0.394	1.299	33	41	42.3	1.512	EP-SG-M32-LGR-A	1SNG601100R0000	EP-SG-M32-GR-A	1SNG601101R0000	EP-SG-M32-BL-A	1SNG601102R0000	25	
			0.591	1.299	1.417	1.665	EP-SG-M32-LGR-B	1SNG601103R0000	EP-SG-M32-GR-B	1SNG601104R0000	EP-SG-M32-BL-B	1SNG601105R0000	25			
			1.299	1.299	EP-SG-M32-LGR-C	1SNG601106R0000	EP-SG-M32-GR-C	1SNG601107R0000	EP-SG-M32-BL-C	1SNG601108R0000	20					
	12-20 0.472-0.787	10 15	0.394	1.654	42	47.1	43.3	1.705	EP-SG-M32-LGR-D	1SNG601109R0000	EP-SG-M32-GR-D	1SNG601110R0000	EP-SG-M32-BL-D	1SNG601111R0000	25	
			0.591	1.654	1.417	1.614	1.665	EP-SG-M32-LGR-E	1SNG601112R0000	EP-SG-M32-GR-E	1SNG601113R0000	EP-SG-M32-BL-E	1SNG601114R0000	25		
			1.654	1.654	EP-SG-M32-LGR-F	1SNG601115R0000	EP-SG-M32-GR-F	1SNG601116R0000	EP-SG-M32-BL-F	1SNG601117R0000	20					
M40x1.5	16-23 0.630-0.906	10 18	0.394	2.087	46	52.4	47.4	1.866	EP-SG-M40-LGR-A	1SNG601118R0000	EP-SG-M40-GR-A	1SNG601119R0000	EP-SG-M40-BL-A	1SNG601120R0000	20	
			0.591	2.087	2.063	1.866	EP-SG-M40-LGR-B	1SNG601121R0000	EP-SG-M40-GR-B	1SNG601122R0000	EP-SG-M40-BL-B	1SNG601123R0000	15			
			2.087	2.087	EP-SG-M40-LGR-C	1SNG601124R0000	EP-SG-M40-GR-C	1SNG601125R0000	EP-SG-M40-BL-C	1SNG601126R0000	20					
	19-28 0.748-1.102	10 18	0.394	2.362	46	52.4	47.4	1.866	EP-SG-M40-LGR-D	1SNG601127R0000	EP-SG-M40-GR-D	1SNG601128R0000	EP-SG-M40-BL-D	1SNG601129R0000	15	
			0.591	2.362	53	59.6	52.4	EP-SG-M40-LGR-E	1SNG601130R0000	EP-SG-M40-GR-E	1SNG601131R0000	EP-SG-M40-BL-E	1SNG601132R0000	10		
			2.362	2.362	EP-SG-M40-LGR-F	1SNG601133R0000	EP-SG-M40-GR-F	1SNG601134R0000	EP-SG-M40-BL-F	1SNG601135R0000	10					
	20-26 0.787-1.024	18	0.709	2.087	53	59.6	52.4	2.063								
			2.087	2.087												
M50x1.5	25-31 0.984-1.220	18	0.709	2.559	60	67.8	54.8	2.157	EP-SG-M50-LGR-A	1SNG601136R0000	EP-SG-M50-GR-A	1SNG601137R0000	EP-SG-M50-BL-A	1SNG601138R0000	10	
			0.709	2.559	60	67.8	54.8	EP-SG-M50-LGR-B	1SNG601139R0000	EP-SG-M50-GR-B	1SNG601140R0000	EP-SG-M50-BL-B	1SNG601141R0000	10		
			2.559	2.559												
M63x1.5	30-38 1.181-1.496	18	0.709	2.559	60	67.8	54.8	2.157								
			0.709	2.559	65	72.4	54.9	EP-SG-M63-LGR-A	1SNG601142R0000	EP-SG-M63-GR-A	1SNG601143R0000	EP-SG-M63-BL-A	1SNG601144R0000	10		
			2.559	2.559	2.850	2.161	EP-SG-M63-LGR-B	1SNG601145R0000	EP-SG-M63-GR-B	1SNG601146R0000	EP-SG-M63-BL-B	1SNG601147R0000	10			
M75x2.0	48-55 1.890-2.165	25	0.984	3.150	75	89	55	2.165	EP-SG-M75-LGR-A	1SNG601148R0000	EP-SG-M75-GR-A	1SNG601149R0000	EP-SG-M75-BL-A	1SNG601150R0000	5	
			0.984	3.150	3.504	2.165										

# Cable Glands

Standard Cable Glands, Polyamide with Threads, without Locknut

## Thread Type NPT acc. to ANSI B1.20.1

Outer Thread Size (Male)	Clamping Range Ø min - max	Outer Thread Length TL	Spanner Width		Outer Ø	Max. Height	Light grey RAL 7035		Grey RAL 7001		Black RAL 9005		Pkg per Box
			Cap	Body			Description	Part Number	Description	Part Number	Description	Part Number	
			SW Cap	SW Body									
mm	mm	mm	mm	mm	mm	mm	mm	mm	mm	mm	mm	mm	
NPT 3/8"	3-7	15	22	22	25	32.2	EP-SG-NPT38-LGR-A	1SNG601151R0000	EP-SG-NPT38-GR-A	1SNG601152R0000	EP-SG-NPT38-BL-A	1SNG601153R0000	50
	0.118-0.276	0.591	0.866	0.866	0.984	1.268							
	5-10	15	22	22	25	32.2	EP-SG-NPT38-LGR-B	1SNG601154R0000	EP-SG-NPT38-GR-B	1SNG601155R0000	EP-SG-NPT38-BL-B	1SNG601156R0000	50
NPT 1/2"	5-9	15	24	24	27	32.4	EP-SG-NPT12-LGR-A	1SNG601157R0000	EP-SG-NPT12-GR-A	1SNG601158R0000	EP-SG-NPT12-BL-A	1SNG601159R0000	50
	0.197-0.354	0.591	0.945	0.945	1.063	1.276							
	6-12	15	24	24	27	32.4	EP-SG-NPT12-LGR-B	1SNG601160R0000	EP-SG-NPT12-GR-B	1SNG601161R0000	EP-SG-NPT12-BL-B	1SNG601162R0000	50
	0.236-0.472	0.591	0.945	0.945	1.063	1.276							
	7-12	15	27	27	30.9	31.9	EP-SG-NPT12-LGR-C	1SNG601163R0000	EP-SG-NPT12-GR-C	1SNG601164R0000	EP-SG-NPT12-BL-C	1SNG601165R0000	50
	0.276-0.472	0.591	1.063	1.063	1.217	1.256							
NPT 3/4"	9-16	15	33	33	37.2	38.4	EP-SG-NPT34-LGR-A	1SNG601169R0000	EP-SG-NPT34-GR-A	1SNG601170R0000	EP-SG-NPT34-BL-A	1SNG601171R0000	25
	0.354-0.630	0.591	1.299	1.299	1.465	1.512							
	13-18	15	33	33	37.2	38.4	EP-SG-NPT34-LGR-B	1SNG601172R0000	EP-SG-NPT34-GR-B	1SNG601173R0000	EP-SG-NPT34-BL-B	1SNG601174R0000	25
NPT 1"	0.512-0.708	0.591	1.299	1.299	1.465	1.512							
	12-20	18	42	42	47.1	43.3	EP-SG-NPT1-LGR-A	1SNG601175R0000	EP-SG-NPT1-GR-A	1SNG601176R0000	EP-SG-NPT1-BL-A	1SNG601177R0000	20
	0.472-0.787	0.709	1.654	1.654	1.854	1.705							
	18-25	18	42	42	47.1	43.3	EP-SG-NPT1-LGR-B	1SNG601178R0000	EP-SG-NPT1-GR-B	1SNG601179R0000	EP-SG-NPT1-BL-B	1SNG601180R0000	20
0.708-0.984	0.709	1.654	1.654	1.854	1.705								

## Thread Type PG acc. to DIN 40430

Outer Thread Size (Male)	Clamping Range Ø min - max	Outer Thread Length TL	Spanner Width		Outer Ø	Max. Height	Light grey RAL 7035		Grey RAL 7001		Black RAL 9005		Pkg per Box
			Cap	Body			Description	Part Number	Description	Part Number	Description	Part Number	
			SW Cap	SW Body									
mm	mm	mm	mm	mm	mm	mm	mm	mm	mm	mm	mm	mm	
PG 7	2-5	8	15	15	17	25.3	EP-SG-PG7-LGR-A	1SNG601181R0000	EP-SG-PG7-GR-A	1SNG601182R0000	EP-SG-PG7-BL-A	1SNG601183R0000	100
	0.079-0.197	0.315	0.591	0.591	0.669	0.996							
	3-6.5	8	15	15	17	25.3	EP-SG-PG7-LGR-B	1SNG601184R0000	EP-SG-PG7-GR-B	1SNG601185R0000	EP-SG-PG7-BL-B	1SNG601186R0000	100
PG 9	0.118-0.02	0.315	0.591	0.591	0.669	0.996							
	2-6	8	19	19	21.7	27.4	EP-SG-PG9-LGR-A	1SNG601187R0000	EP-SG-PG9-GR-A	1SNG601188R0000	EP-SG-PG9-BL-A	1SNG601189R0000	50
	0.079-0.236	0.315	0.748	0.748	0.854	1.079							
PG 11	4-8	8	19	19	21.7	27.4	EP-SG-PG9-LGR-B	1SNG601190R0000	EP-SG-PG9-GR-B	1SNG601191R0000	EP-SG-PG9-BL-B	1SNG601192R0000	50
	0.157-0.315	0.315	0.748	0.748	0.854	1.079							
	3-7	8	22	22	25	32.2	EP-SG-PG11-LGR-A	1SNG601193R0000	EP-SG-PG11-GR-A	1SNG601194R0000	EP-SG-PG11-BL-A	1SNG601195R0000	50
PG 13.5	0.118-0.276	0.315	0.866	0.866	0.984	1.268							
	5-10	8	22	22	25	32.2	EP-SG-PG11-LGR-B	1SNG601196R0000	EP-SG-PG11-GR-B	1SNG601197R0000	EP-SG-PG11-BL-B	1SNG601198R0000	50
	0.197-0.394	0.315	0.866	0.866	0.984	1.268							
PG 16	5-9	10	24	24	27	32.4	EP-SG-PG135-LGR-A	1SNG601199R0000	EP-SG-PG135-GR-A	1SNG601200R0000	EP-SG-PG135-BL-A	1SNG601201R0000	50
	0.197-0.354	0.394	0.945	0.945	1.063	1.276							
	6-12	10	24	24	27	32.4	EP-SG-PG135-LGR-B	1SNG601202R0000	EP-SG-PG135-GR-B	1SNG601203R0000	EP-SG-PG135-BL-B	1SNG601204R0000	50
PG 21	0.236-0.472	0.394	0.945	0.945	1.063	1.276							
	7-12	10	27	27	30.9	31.9	EP-SG-PG16-LGR-A	1SNG601205R0000	EP-SG-PG16-GR-A	1SNG601206R0000	EP-SG-PG16-BL-A	1SNG601207R0000	50
	0.276-0.472	0.394	1.063	1.063	1.217	1.256							
PG 29	10-14	10	27	27	30.9	31.9	EP-SG-PG16-LGR-B	1SNG601208R0000	EP-SG-PG16-GR-B	1SNG601209R0000	EP-SG-PG16-BL-B	1SNG601210R0000	50
	0.394-0.551	0.394	1.063	1.063	1.217	1.256							
	9-16	11	33	33	37.2	38.4	EP-SG-PG21-LGR-A	1SNG601211R0000	EP-SG-PG21-GR-A	1SNG601212R0000	EP-SG-PG21-BL-A	1SNG601213R0000	25
PG 36	0.354-0.630	0.433	1.299	1.299	1.465	1.512							
	13-18	11	33	33	37.2	38.4	EP-SG-PG21-LGR-B	1SNG601214R0000	EP-SG-PG21-GR-B	1SNG601215R0000	EP-SG-PG21-BL-B	1SNG601216R0000	25
	0.354-0.708	0.433	1.299	1.299	1.465	1.512							
PG 42	12-20	11	42	42	47.1	43.3	EP-SG-PG29-LGR-A	1SNG601217R0000	EP-SG-PG29-GR-A	1SNG601218R0000	EP-SG-PG29-BL-A	1SNG601219R0000	20
	0.472-0.787	0.433	1.654	1.654	1.854	1.705							
	18-25	11	42	42	47.1	43.3	EP-SG-PG29-LGR-B	1SNG601220R0000	EP-SG-PG29-GR-B	1SNG601221R0000	EP-SG-PG29-BL-B	1SNG601222R0000	20
PG 48	0.708-0.984	0.433	1.654	1.654	1.854	1.705							
	20-26	13	53	53	59.6	52.4	EP-SG-PG36-LGR-A	1SNG601223R0000	EP-SG-PG36-GR-A	1SNG601224R0000	EP-SG-PG36-BL-A	1SNG601225R0000	10
	0.787-1.024	0.512	2.087	2.087	2.346	2.063							
PG 54	22-32	13	53	53	59.6	52.4	EP-SG-PG36-LGR-B	1SNG601226R0000	EP-SG-PG36-GR-B	1SNG601227R0000	EP-SG-PG36-BL-B	1SNG601228R0000	10
	0.866-1.260	0.512	2.087	2.087	2.346	2.063							
	25-31	13	60	60	67.8	54.8	EP-SG-PG42-LGR-A	1SNG601229R0000	EP-SG-PG42-GR-A	1SNG601230R0000	EP-SG-PG42-BL-A	1SNG601231R0000	10
PG 60	0.984-1.220	0.512	2.362	2.362	2.669	2.157							
	30-38	13	60	60	67.8	54.8	EP-SG-PG42-LGR-B	1SNG601232R0000	EP-SG-PG42-GR-B	1SNG601233R0000	EP-SG-PG42-BL-B	1SNG601234R0000	10
	1.181-1.496	0.512	2.362	2.362	2.669	2.157							
PG 72	29-35	13	60	60	67.8	54.8	EP-SG-PG48-LGR-A	1SNG601235R0000	EP-SG-PG48-GR-A	1SNG601236R0000	EP-SG-PG48-BL-A	1SNG601237R0000	10
	1.142-1.378	0.512	2.362	2.362	2.669	2.157							
	34-44	13	60	60	67.8	54.8	EP-SG-PG48-LGR-B	1SNG601238R0000	EP-SG-PG48-GR-B	1SNG601239R0000	EP-SG-PG48-BL-B	1SNG601240R0000	10
1.339-1.732	0.512	2.362	2.362	2.669	2.157								

All the main technical data provided are "manufacturer" values  
Refers to UL files for precise approval per products



# Cable Glands

Standard Cable Glands, Polyamide with Threads, with Locknut



## Polyamide cable glands with lamellar clamping

- For standard industrial applications
- Material: Body, Cap: PA 6 / Seal: CR
- Ingress Protection Rating: IP68 - 5 Bar, 30 min / IP 66
- UL Environmental Rating: TYPE 1, 4X acc. to UL 50E
- Flammability: V2 according to UL94
- Operating temperature:
  - Permanent: -20 °C to +100 °C
  - Intermittent: -30 °C to +150 °C
- Cable type: Non armoured
- Accessories (refers to dedicated page): Locknut (included), Washer Gaskets, Dome Plugs

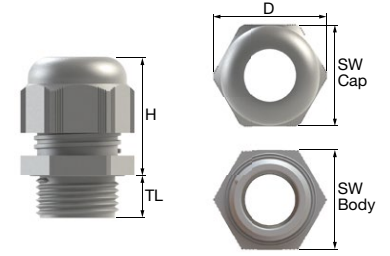

### Thread Type METRIC acc. to EN 60423

Outer Thread Size (Male)	Clamping Range Ø min - max	Outer Thread Length		Spanner Width		Outer Ø		Max. Height	Light grey RAL 7035 □		Grey RAL 7001 ■		Black RAL 9005 ■		Pkg per Box
		TL	mm	in	Cap	Body	D		H	Description	Part Number	Description	Part Number	Description	
M16x1.5	2-6 0.079-0.236	8	0.315	19	19	21.7	27.4	EP-SGL-M16-LGR-A	1SNG626001R0000	EP-SGL-M16-GR-A	1SNG626002R0000	EP-SGL-M16-BL-A	1SNG626003R0000	50	
		10	0.394	0.748	0.748	0.854	1.079	EP-SGL-M16-LGR-B	1SNG626004R0000	EP-SGL-M16-GR-B	1SNG626005R0000	EP-SGL-M16-BL-B	1SNG626006R0000	50	
		15	0.591						EP-SGL-M16-LGR-C	1SNG626007R0000	EP-SGL-M16-GR-C	1SNG626008R0000	EP-SGL-M16-BL-C	1SNG626009R0000	50
	3-7 0.118-0.276	10	0.394	22	22	25	32.2	EP-SGL-M16-LGR-D	1SNG626010R0000	EP-SGL-M16-GR-D	1SNG626011R0000	EP-SGL-M16-BL-D	1SNG626012R0000	50	
		15	0.591	0.866	0.866	0.984	1.268	EP-SGL-M16-LGR-E	1SNG626013R0000	EP-SGL-M16-GR-E	1SNG626014R0000	EP-SGL-M16-BL-E	1SNG626015R0000	50	
		8	0.315	19	19	21.7	27.4	EP-SGL-M16-LGR-F	1SNG626016R0000	EP-SGL-M16-GR-F	1SNG626017R0000	EP-SGL-M16-BL-F	1SNG626018R0000	50	
	4-8 0.157-0.315	10	0.394	0.748	0.748	0.854	1.079	EP-SGL-M16-LGR-G	1SNG626019R0000	EP-SGL-M16-GR-G	1SNG626020R0000	EP-SGL-M16-BL-G	1SNG626021R0000	50	
		15	0.591						EP-SGL-M16-LGR-H	1SNG626022R0000	EP-SGL-M16-GR-H	1SNG626023R0000	EP-SGL-M16-BL-H	1SNG626024R0000	50
		10	0.394	22	22	25	32.2	EP-SGL-M16-LGR-I	1SNG626025R0000	EP-SGL-M16-GR-I	1SNG626026R0000	EP-SGL-M16-BL-I	1SNG626027R0000	50	
	5-10 0.197-0.394	15	0.591	0.866	0.866	0.984	1.268	EP-SGL-M16-LGR-J	1SNG626028R0000	EP-SGL-M16-GR-J	1SNG626029R0000	EP-SGL-M16-BL-J	1SNG626030R0000	50	
		5-9	10	0.394	24	24	27	32.4	EP-SGL-M20-LGR-A	1SNG626031R0000	EP-SGL-M20-GR-A	1SNG626032R0000	EP-SGL-M20-BL-A	1SNG626033R0000	50
		0.197-0.354	15	0.591	0.945	0.945	1.063	1.276	EP-SGL-M20-LGR-B	1SNG626034R0000	EP-SGL-M20-GR-B	1SNG626035R0000	EP-SGL-M20-BL-B	1SNG626036R0000	50
6-12		10	0.394	24	24	27	32.4	EP-SGL-M20-LGR-C	1SNG626037R0000	EP-SGL-M20-GR-C	1SNG626038R0000	EP-SGL-M20-BL-C	1SNG626039R0000	50	
0.236-0.472		15	0.591	0.945	0.945	1.063	1.276	EP-SGL-M20-LGR-D	1SNG626040R0000	EP-SGL-M20-GR-D	1SNG626041R0000	EP-SGL-M20-BL-D	1SNG626042R0000	50	
7-12		10	0.394	27	27	30.9	31.9	EP-SGL-M20-LGR-E	1SNG626043R0000	EP-SGL-M20-GR-E	1SNG626044R0000	EP-SGL-M20-BL-E	1SNG626045R0000	50	
0.276-0.472	15	0.591	1.063	1.063	1.217	1.256	EP-SGL-M20-LGR-F	1SNG626046R0000	EP-SGL-M20-GR-F	1SNG626047R0000	EP-SGL-M20-BL-F	1SNG626048R0000	50		
	7-13	10	0.394	25	25	27.5	34	EP-SGL-M20-LGR-G	1SNG626049R0000	EP-SGL-M20-GR-G	1SNG626050R0000	EP-SGL-M20-BL-G	1SNG626051R0000	50	
	0.276-0.512		0.984	0.984	1.083	1.339									
	10-14	10	0.394	27	27	30.9	31.9	EP-SGL-M20-LGR-H	1SNG626052R0000	EP-SGL-M20-GR-H	1SNG626053R0000	EP-SGL-M20-BL-H	1SNG626054R0000	50	
	0.394-0.551	15	0.591	1.063	1.063	1.217	1.256	EP-SGL-M20-LGR-I	1SNG626055R0000	EP-SGL-M20-GR-I	1SNG626056R0000	EP-SGL-M20-BL-I	1SNG626057R0000	50	
	9-13	8	0.315	29	29	32.5	37.7	EP-SGL-M25-LGR-A	1SNG626058R0000	EP-SGL-M25-GR-A	1SNG626059R0000	EP-SGL-M25-BL-A	1SNG626060R0000	25	
M25x1.5	0.354-0.512	15	0.591	1.142	1.142	1.280	1.484	EP-SGL-M25-LGR-B	1SNG626061R0000	EP-SGL-M25-GR-B	1SNG626062R0000	EP-SGL-M25-BL-B	1SNG626063R0000	25	
		9-16	10	0.394	33	33	37.2	38.4	EP-SGL-M25-LGR-C	1SNG626064R0000	EP-SGL-M25-GR-C	1SNG626065R0000	EP-SGL-M25-BL-C	1SNG626066R0000	25
		0.354-0.630	15	0.591	1.299	1.299	1.465	1.512	EP-SGL-M25-LGR-D	1SNG626067R0000	EP-SGL-M25-GR-D	1SNG626068R0000	EP-SGL-M25-BL-D	1SNG626069R0000	25
	11-17	8	0.315	29	29	32.5	37.7	EP-SGL-M25-LGR-E	1SNG626070R0000	EP-SGL-M25-GR-E	1SNG626071R0000	EP-SGL-M25-BL-E	1SNG626072R0000	25	
	0.433-0.669	15	0.591	1.142	1.142	1.280	1.484	EP-SGL-M25-LGR-F	1SNG626073R0000	EP-SGL-M25-GR-F	1SNG626074R0000	EP-SGL-M25-BL-F	1SNG626075R0000	25	
	13-18	10	0.394	33	33	37.2	38.4	EP-SGL-M25-LGR-G	1SNG626076R0000	EP-SGL-M25-GR-G	1SNG626077R0000	EP-SGL-M25-BL-G	1SNG626078R0000	25	
	0.512-0.708	15	0.591	1.299	1.299	1.465	1.512	EP-SGL-M25-LGR-H	1SNG626079R0000	EP-SGL-M25-GR-H	1SNG626080R0000	EP-SGL-M25-BL-H	1SNG626081R0000	25	
		11-15	10	0.394	36	36	41	42.3	EP-SGL-M32-LGR-A	1SNG626082R0000	EP-SGL-M32-GR-A	1SNG626083R0000	EP-SGL-M32-BL-A	1SNG626084R0000	20
		0.433-0.591	15	0.591	1.417	1.417	1.614	1.665	EP-SGL-M32-LGR-B	1SNG626085R0000	EP-SGL-M32-GR-B	1SNG626086R0000	EP-SGL-M32-BL-B	1SNG626087R0000	20
	12-20 0.472-0.787	15	0.591	42	42	47.1	43.3	EP-SGL-M32-LGR-C	1SNG626088R0000	EP-SGL-M32-GR-C	1SNG626089R0000	EP-SGL-M32-BL-C	1SNG626090R0000	20	
				1.654	1.654	1.854	1.705								
		15-21	10	0.394	36	36	41	42.3	EP-SGL-M32-LGR-D	1SNG626091R0000	EP-SGL-M32-GR-D	1SNG626092R0000	EP-SGL-M32-BL-D	1SNG626093R0000	20
0.591-0.827		15	0.591	1.417	1.417	1.614	1.665	EP-SGL-M32-LGR-E	1SNG626094R0000	EP-SGL-M32-GR-E	1SNG626095R0000	EP-SGL-M32-BL-E	1SNG626096R0000	20	
18-25		15	0.591	42	42	47.1	43.3	EP-SGL-M32-LGR-F	1SNG626097R0000	EP-SGL-M32-GR-F	1SNG626098R0000	EP-SGL-M32-BL-F	1SNG626099R0000	20	
0.708-0.984			1.654	1.654	1.854	1.705									
M40x1.5	16-23 0.630-0.906	10	0.394	46	46	52.4	47.4	EP-SGL-M40-LGR-A	1SNG626100R0000	EP-SGL-M40-GR-A	1SNG626101R0000	EP-SGL-M40-BL-A	1SNG626102R0000	10	
		18	0.709	1.811	1.811	2.063	1.866	EP-SGL-M40-LGR-B	1SNG626103R0000	EP-SGL-M40-GR-B	1SNG626104R0000	EP-SGL-M40-BL-B	1SNG626105R0000	15	
	19-28 0.748-1.102	10	0.394	46	46	52.4	47.4	EP-SGL-M40-LGR-C	1SNG626106R0000	EP-SGL-M40-GR-C	1SNG626107R0000	EP-SGL-M40-BL-C	1SNG626108R0000	10	
		18	0.709	1.811	1.811	2.063	1.866	EP-SGL-M40-LGR-D	1SNG626109R0000	EP-SGL-M40-GR-D	1SNG626110R0000	EP-SGL-M40-BL-D	1SNG626111R0000	15	
	20-26 0.787-1.024	18	0.709	53	53	59.6	52.4	EP-SGL-M40-LGR-E	1SNG626112R0000	EP-SGL-M40-GR-E	1SNG626113R0000	EP-SGL-M40-BL-E	1SNG626114R0000	10	
				2.087	2.087	2.346	2.063								
	22-32	18	0.709	53	53	59.6	52.4	EP-SGL-M40-LGR-F	1SNG626115R0000	EP-SGL-M40-GR-F	1SNG626116R0000	EP-SGL-M40-BL-F	1SNG626117R0000	10	
	0.866-1.260		2.087	2.087	2.346	2.063									

All the main technical data provided are "manufacturer" values  
Refers to UL files for precise approval per products





# Cable Glands

Standard Cable Glands, Polyamide with Threads, with Locknut

## Thread Type NPT acc. to ANSI B1.20.1

Outer Thread Size (Male)	Clamping Range Ø min - max	Outer Thread Length	Spanner Width		Outer Ø		Max. Height	Light grey RAL 7035		Grey RAL 7001		Black RAL 9005		Pkg per Box
			Cap	Body	Cap	Body		Description	Part Number	Description	Part Number	Description	Part Number	
			SW Cap	SW Body	D	H								
NPT 1/2"	5-9	15	24	24	27	32.4	EP-SGL-NPT12-LGR-A	1SNG626118R0000	EP-SGL-NPT12-GR-A	1SNG626119R0000	EP-SGL-NPT12-BL-A	1SNG626120R0000	50	
	0.197-0.354	0.591	0.945	0.945	1.063	1.276								
	6-12	15	24	24	27	32.4	EP-SGL-NPT12-LGR-B	1SNG626121R0000	EP-SGL-NPT12-GR-B	1SNG626122R0000	EP-SGL-NPT12-BL-B	1SNG626123R0000	50	
	0.236-0.472	0.591	0.945	0.945	1.063	1.276								
	7-12	15	27	27	30.9	31.9	EP-SGL-NPT12-LGR-C	1SNG626124R0000	EP-SGL-NPT12-GR-C	1SNG626125R0000	EP-SGL-NPT12-BL-C	1SNG626126R0000	50	
	0.276-0.472	0.591	1.063	1.063	1.217	1.256								
NPT 3/4"	9-16	15	33	33	37.2	38.4	EP-SGL-NPT34-LGR-A	1SNG626130R0000	EP-SGL-NPT34-GR-A	1SNG626131R0000	EP-SGL-NPT34-BL-A	1SNG626132R0000	25	
	0.354-0.630	0.591	1.299	1.299	1.465	1.512								
	13-18	15	33	33	37.2	38.4	EP-SGL-NPT34-LGR-B	1SNG626133R0000	EP-SGL-NPT34-GR-B	1SNG626134R0000	EP-SGL-NPT34-BL-B	1SNG626135R0000	25	
NPT 1"	12-20	18	42	42	47.1	43.3	EP-SGL-NPT1-LGR-A	1SNG626136R0000	EP-SGL-NPT1-GR-A	1SNG626137R0000	EP-SGL-NPT1-BL-A	1SNG626138R0000	20	
	0.472-0.787	0.709	1.654	1.654	1.854	1.705								
	18-25	18	42	42	47.1	43.3	EP-SGL-NPT1-LGR-B	1SNG626139R0000	EP-SGL-NPT1-GR-B	1SNG626140R0000	EP-SGL-NPT1-BL-B	1SNG626141R0000	20	
	0.708-0.984	0.709	1.654	1.654	1.854	1.705								

## Thread Type PG acc. to DIN 40430

Outer Thread Size (Male)	Clamping Range Ø min - max	Outer Thread Length	Spanner Width		Outer Ø		Max. Height	Light grey RAL 7035		Grey RAL 7001		Black RAL 9005		Pkg per Box
			Cap	Body	Cap	Body		Description	Part Number	Description	Part Number	Description	Part Number	
			SW Cap	SW Body	D	H								
PG 9	2-6	8	19	19	21.7	27.4	EP-SGL-PG9-LGR-A	1SNG626142R0000	EP-SGL-PG9-GR-A	1SNG626143R0000	EP-SGL-PG9-BL-A	1SNG626144R0000	50	
	0.079-0.236	0.315	0.748	0.748	0.854	1.079								
	4-8	8	19	19	21.7	27.4	EP-SGL-PG9-LGR-B	1SNG626145R0000	EP-SGL-PG9-GR-B	1SNG626146R0000	EP-SGL-PG9-BL-B	1SNG626147R0000	50	
PG 11	3-7	8	22	22	25	32.2	EP-SGL-PG11-LGR-A	1SNG626148R0000	EP-SGL-PG11-GR-A	1SNG626149R0000	EP-SGL-PG11-BL-A	1SNG626150R0000	50	
	0.118-0.276	0.315	0.866	0.866	0.984	1.268								
	5-10	8	22	22	25	32.2	EP-SGL-PG11-LGR-B	1SNG626151R0000	EP-SGL-PG11-GR-B	1SNG626152R0000	EP-SGL-PG11-BL-B	1SNG626153R0000	50	
PG 13.5	5-9	10	24	24	27	32.4	EP-SGL-PG135-LGR-A	1SNG626154R0000	EP-SGL-PG135-GR-A	1SNG626155R0000	EP-SGL-PG135-BL-A	1SNG626156R0000	50	
	0.197-0.354	0.394	0.945	0.945	1.063	1.276								
	6-12	10	24	24	27	32.4	EP-SGL-PG135-LGR-B	1SNG626157R0000	EP-SGL-PG135-GR-B	1SNG626158R0000	EP-SGL-PG135-BL-B	1SNG626159R0000	50	
PG 16	7-12	10	27	27	30.9	31.9	EP-SGL-PG16-LGR-A	1SNG626160R0000	EP-SGL-PG16-GR-A	1SNG626161R0000	EP-SGL-PG16-BL-A	1SNG626162R0000	50	
	0.276-0.472	0.394	1.063	1.063	1.217	1.256								
	10-14	10	27	27	30.9	31.9	EP-SGL-PG16-LGR-B	1SNG626163R0000	EP-SGL-PG16-GR-B	1SNG626164R0000	EP-SGL-PG16-BL-B	1SNG626165R0000	50	
PG 21	9-16	11	33	33	37.2	38.4	EP-SGL-PG21-LGR-A	1SNG626166R0000	EP-SGL-PG21-GR-A	1SNG626167R0000	EP-SGL-PG21-BL-A	1SNG626168R0000	25	
	0.354-0.630	0.433	1.299	1.299	1.465	1.512								
	13-18	11	33	33	37.2	38.4	EP-SGL-PG21-LGR-B	1SNG626169R0000	EP-SGL-PG21-GR-B	1SNG626170R0000	EP-SGL-PG21-BL-B	1SNG626171R0000	25	
PG 29	12-20	11	42	42	47.1	43.3	EP-SGL-PG29-LGR-A	1SNG626172R0000	EP-SGL-PG29-GR-A	1SNG626173R0000	EP-SGL-PG29-BL-A	1SNG626174R0000	20	
	0.472-0.787	0.433	1.654	1.654	1.854	1.705								
	18-25	11	42	42	47.1	43.3	EP-SGL-PG29-LGR-B	1SNG626175R0000	EP-SGL-PG29-GR-B	1SNG626176R0000	EP-SGL-PG29-BL-B	1SNG626177R0000	20	
	0.708-0.984	0.433	1.654	1.654	1.854	1.705								

All the main technical data provided are "manufacturer" values  
Refers to UL files for precise approval per products



# Cable Glands

Standard Cable Glands, Brass with Threads, without Locknut



## Brass cable glands with lamellar clamping

- For standard industrial applications in harsh environments
- Material: Body, Cap: Brass Nickel plated / Seal: CR / Clamping insert: PA 6 / O-Ring: NBR
- Ingress Protection Rating: IP 68 - 5 Bar, 30 min / IP 66
- UL Environmental Rating: TYPE 1, 4X acc. to UL 50E
- Flammability: V2 according to UL94
- Operating temperature:
  - Permanent: -20 °C to +100 °C
  - Intermittent: -40 °C to +150 °C
- Cable type: Non armoured
- Accessories (refers to dedicated page): Locknuts, O-Rings (included for Metric and PG types), Washer Gaskets (for NPT type only), Dome Plugs

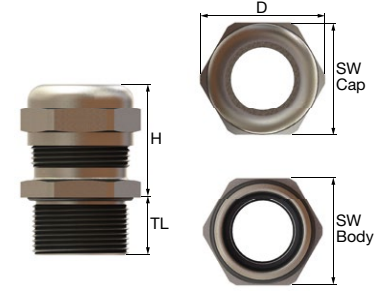

## Thread Type METRIC acc. to EN 60423

Outer Thread Size (Male)	Clamping Range Ø min - max		Outer Thread Length		Spanner Width Cap		Body		Outer Ø		Max. Height		Description	Part Number	Pkg per Box	
	mm	in	mm	in	mm	in	mm	in	mm	in	mm	in				
M12x1.5	2 - 5	0.079-0.197	6	0.236	14	0.551	14	0.551	15.5	0.610	24	0.945	EM-SG-M12-MET-A	1SNG602001R0000	50	
			12	0.472										EM-SG-M12-MET-B	1SNG602002R0000	50
	3 - 6.5	0.118-0.02	6	0.236	14	0.551	14	0.551	15.5	0.610	24	0.945	EM-SG-M12-MET-C	1SNG602003R0000	50	
			12	0.472										EM-SG-M12-MET-D	1SNG602004R0000	50
M16x1.5	2 - 6	0.079-0.236	7	0.276	17	0.669	18	0.709	20	0.787	25.5	1.004	EM-SG-M16-MET-A	1SNG602005R0000	50	
			12	0.472										EM-SG-M16-MET-B	1SNG602006R0000	50
	3-7	0.118-0.276	7	0.276	20	0.787	20	0.787	22	0.866	30.5	1.201	EM-SG-M16-MET-C	1SNG602007R0000	50	
			12	0.472										EM-SG-M16-MET-D	1SNG602008R0000	50
	4-8	0.157-0.315	7	0.276	17	0.669	18	0.709	20	0.787	25.5	1.004	EM-SG-M16-MET-E	1SNG602009R0000	50	
			12	0.472										EM-SG-M16-MET-F	1SNG602010R0000	50
	5-10	0.197-0.394	6.5	0.256	17	0.669	18	0.709	20	0.787	25.5	1.004	EM-SG-M16-MET-G	1SNG602011R0000	50	
			7	0.276										EM-SG-M16-MET-H	1SNG602012R0000	50
				12	0.472									EM-SG-M16-MET-I	1SNG602013R0000	50
	M20x1.5	5-9	0.197-0.354	8	0.315	22	0.866	22	0.866	24.5	0.965	28	1.102	EM-SG-M20-MET-A	1SNG602014R0000	50
12				0.472										EM-SG-M20-MET-B	1SNG602015R0000	50
6-12		0.236-0.472	8	0.315	22	0.866	22	0.866	24.5	0.965	26.5	1.043	EM-SG-M20-MET-C	1SNG602016R0000	50	
			12	0.472										EM-SG-M20-MET-D	1SNG602017R0000	50
7-13		0.276-0.512	8	0.315	24	0.945	24	0.945	26.5	1.043	30.5	1.201	EM-SG-M20-MET-E	1SNG602018R0000	50	
10-14		0.394-0.551	8	0.315	24	0.945	24	0.945	26.5	1.043	30	1.181	EM-SG-M20-MET-F	1SNG602019R0000	25	
			12	0.472									EM-SG-M20-MET-G	1SNG602020R0000	25	
M25x1.5	7-12	0.276-0.472	8	0.315	24	0.945	27	1.063	30	1.181	30	1.181	EM-SG-M25-MET-A	1SNG602021R0000	25	
			12	0.472										EM-SG-M25-MET-B	1SNG602022R0000	25
	9-16	0.354-0.630	8	0.315	30	1.181	30	1.181	33	1.299	35	1.378	EM-SG-M25-MET-C	1SNG602023R0000	25	
			12	0.472										EM-SG-M25-MET-D	1SNG602024R0000	25
	10-14	0.394-0.551	8	0.315	24	0.945	27	1.063	30	1.181	30	1.181	EM-SG-M25-MET-E	1SNG602025R0000	25	
			12	0.472										EM-SG-M25-MET-F	1SNG602026R0000	25
	11-17	0.433-0.669	8	0.315	27	1.063	27	1.063	30	1.181	32.5	1.280	EM-SG-M25-MET-G	1SNG602027R0000	25	
			12	0.472										EM-SG-M25-MET-H	1SNG602028R0000	25
13-18	0.512-0.708	8	0.315	30	1.181	30	1.181	33	1.299	35	1.378	EM-SG-M25-MET-I	1SNG602029R0000	25		
		12	0.472										EM-SG-M25-MET-J	1SNG602030R0000	25	
M32x1.5	9-16	0.354-0.630	9	0.354	30	1.181	34	1.339	37.5	1.476	35	1.378	EM-SG-M32-MET-A	1SNG602031R0000	10	
			15	0.591										EM-SG-M32-MET-B	1SNG602032R0000	10
	12-20	0.472-0.787	9	0.354	40	1.575	40	1.575	44.5	1.752	46	1.811	EM-SG-M32-MET-C	1SNG602033R0000	10	
			15	0.591										EM-SG-M32-MET-D	1SNG602034R0000	10
	13-18	0.512-0.708	9	0.354	30	1.181	34	1.339	37.5	1.476	35	1.378	EM-SG-M32-MET-E	1SNG602035R0000	10	
			15	0.591										EM-SG-M32-MET-F	1SNG602036R0000	10
15-21	0.591-0.827	8	0.315	34	1.339	34	1.339	37.5	1.476	38	1.496	EM-SG-M32-MET-G	1SNG602037R0000	10		
		15	0.591										EM-SG-M32-MET-H	1SNG602038R0000	10	
18-25	0.708-0.984	9	0.354	40	1.575	40	1.575	44.5	1.752	46	1.811	EM-SG-M32-MET-I	1SNG602039R0000	10		
		15	0.591										EM-SG-M32-MET-J	1SNG602040R0000	10	
M40x1.5	12-20	0.472-0.787	9	0.354	40	1.575	43	1.693	48.5	1.909	40.5	1.594	EM-SG-M40-MET-A	1SNG602041R0000	10	
			15	0.591										EM-SG-M40-MET-B	1SNG602042R0000	10
	18-25	0.708-0.984	9	0.354	40	1.575	43	1.693	48.5	1.909	40.5	1.594	EM-SG-M40-MET-C	1SNG602043R0000	10	
			15	0.591										EM-SG-M40-MET-D	1SNG602044R0000	10
	16-23	0.630-0.906	9	0.354	43	1.693	43	1.693	48.5	1.909	45.5	1.791	EM-SG-M40-MET-E	1SNG602045R0000	10	
			15	0.591										EM-SG-M40-MET-F	1SNG602046R0000	10
	19-28	0.748-1.102	9	0.354	43	1.693	43	1.693	48.5	1.909	45.5	1.791	EM-SG-M40-MET-G	1SNG602047R0000	10	
			15	0.591										EM-SG-M40-MET-H	1SNG602048R0000	10
22-32	0.866-1.260	9	0.354	50	1.969	50	1.969	55.5	2.185	54.5	2.146	EM-SG-M40-MET-I	1SNG602049R0000	5		
		15	0.591										EM-SG-M40-MET-J	1SNG602050R0000	5	
M50x1.5	20-26	0.787-1.024	9	0.354	50	1.969	55	2.165	61	2.402	50	1.969	EM-SG-M50-MET-A	1SNG602051R0000	5	
			15	0.591										EM-SG-M50-MET-B	1SNG602052R0000	5
	22-32	0.866-1.260	9	0.354	50	1.969	55	2.165	61	2.402	50	1.969	EM-SG-M50-MET-C	1SNG602053R0000	5	
			15	0.591										EM-SG-M50-MET-D	1SNG602054R0000	5
	27-38	1.063-1.496	9	0.354	58	2.283	58	2.283	64	2.520	54	2.126	EM-SG-M50-MET-E	1SNG602055R0000	5	
15			0.591										EM-SG-M50-MET-F	1SNG602056R0000	5	
34-44	1.339-1.732	9	0.354	64	2.520	64	2.520	70	2.756	55	2.165	EM-SG-M50-MET-G	1SNG602057R0000	5		
		15	0.591										EM-SG-M50-MET-H	1SNG602058R0000	5	
M63x1.5	29-35	1.142-1.378	10	0.394	64	2.520	68	2.677	75	2.953	56	2.205	EM-SG-M63-MET-A	1SNG602059R0000	5	
			14	0.551										EM-SG-M63-MET-B	1SNG602060R0000	5
			18	0.709										EM-SG-M63-MET-C	1SNG602061R0000	5
	34-44	1.339-1.732	10	0.394	64	2.520	68	2.677	75	2.953	55	2.165	EM-SG-M63-MET-D	1SNG602062R0000	5	
			15	0.591										EM-SG-M63-MET-E	1SNG602063R0000	5
			14	0.551										EM-SG-M63-MET-F	1SNG602064R0000	5
	18	0.709												EM-SG-M63-MET-G	1SNG602065R0000	5
			10	0.394	75	2.953	75	2.953	83	3.268	53	2.087	EM-SG-M63-MET-H	1SNG602066R0000	5	
	37-53	1.457-2.087	10	0.394	75	2.953	75	2.953	83	3.268	53	2.087	EM-SG-M63-MET-I	1SNG602067R0000	5	
			18	0.709												

# Cable Glands

Standard Cable Glands, Brass with Threads, without Locknut

## Thread Type NPT acc. to ANSI B1.20.1

Outer Thread Size (Male)	Clamping Range Ø		Outer Thread Length		Spanner Width				Outer Ø		Max. Height		Description	Part Number	Pkg per Box
	min - max		TL		Cap		Body		D		H				
	mm	in	mm	in	mm	in	mm	in	mm	in	mm	in			
NPT 3/8"	2 - 6	0.079-0.236	11.5	0.453	17	0.669	19	0.748	21	0.827	25.5	1.004	EM-SG-NPT38-MET-A	1SNG602068R0000	50
	3 - 7	0.118-0.276	11.5	0.453	20	0.787	20	0.787	22	0.866	31.5	1.240	EM-SG-NPT38-MET-B	1SNG602069R0000	50
	4 - 8	0.157-0.315	11.5	0.453	17	0.669	19	0.748	21	0.827	25.5	1.004	EM-SG-NPT38-MET-C	1SNG602070R0000	50
	5 - 10	0.197-0.394	11.5	0.453	20	0.787	20	0.787	22	0.866	31.5	1.240	EM-SG-NPT38-MET-D	1SNG602071R0000	50
NPT 1/2"	5 - 9	0.197-0.354	13	0.512	22	0.866	22	0.866	24.5	0.965	27.5	1.083	EM-SG-NPT12-MET-A	1SNG602072R0000	50
	6 - 12	0.236-0.472	13	0.512	22	0.866	22	0.866	24.5	0.965	27.5	1.083	EM-SG-NPT12-MET-B	1SNG602073R0000	25
	7 - 12	0.276-0.472	13	0.512	24	0.945	24	0.945	26.8	1.055	30	1.181	EM-SG-NPT12-MET-C	1SNG602074R0000	25
	10 - 14	0.394-0.551	13	0.512	24	0.945	24	0.945	26.8	1.055	30	1.181	EM-SG-NPT12-MET-D	1SNG602075R0000	25
NPT 3/4"	9 - 16	0.354-0.630	13	0.512	30	1.181	30	1.181	33	1.299	38	1.496	EM-SG-NPT34-MET-A	1SNG602076R0000	25
	13 - 18	0.512-0.708	13	0.512	30	1.181	30	1.181	33	1.299	38	1.496	EM-SG-NPT34-MET-B	1SNG602077R0000	25
NPT 1"	12 - 20	0.472-0.787	13	0.512	40	1.575	43	1.693	48.5	1.909	45.5	1.791	EM-SG-NPT1-MET-A	1SNG602078R0000	10
	18 - 25	0.708-0.984	13	0.512	40	1.575	43	1.693	48.5	1.909	45.5	1.791	EM-SG-NPT1-MET-B	1SNG602079R0000	10
NPT 1 1/4"	22 - 32	0.866-1.260	25.6	1.008	50	1.969	50	1.969	55.5	2.185	50	1.969	EM-SG-NPT114-MET-A	1SNG602080R0000	5
NPT 1 1/2"	30 - 38	1.181-1.496	26	1.024	58	2.283	58	2.283	64	2.520	51	2.008	EM-SG-NPT112-MET-A	1SNG602081R0000	5
NPT 2"	34 - 44	1.339-1.732	27	1.063	64	2.520	64	2.520	70	2.756	55	2.165	EM-SG-NPT2-MET-A	1SNG602082R0000	5

## Thread Type PG acc. to DIN 40430

Outer Thread Size (Male)	Clamping Range Ø		Outer Thread Length		Spanner Width				Outer Ø		Max. Height		Description	Part Number	Pkg per Box
	min - max		TL		Cap		Body		D		H				
	mm	in	mm	in	mm	in	mm	in	mm	in	mm	in			
PG 7	2 - 5	0.079-0.197	6	0.236	14	0.551	14	0.551	15.5	0.610	24	0.945	EM-SG-PG7-MET-A	1SNG602083R0000	50
			10	0.394									EM-SG-PG7-MET-B	1SNG602084R0000	50
	3 - 6.5	0.118-0.02	6	0.236	14	0.551	14	0.551	15.5	0.610	24	0.945	EM-SG-PG7-MET-C	1SNG602085R0000	50
			10	0.394									EM-SG-PG7-MET-D	1SNG602086R0000	50
PG 9	2 - 6	0.079-0.236	6	0.236	17	0.669	17	0.669	18.9	0.744	25.5	1.004	EM-SG-PG9-MET-A	1SNG602087R0000	50
			10	0.394									EM-SG-PG9-MET-B	1SNG602088R0000	50
	4-8	0.157-0.315	6	0.236	17	0.669	17	0.669	18.9	0.744	25.5	1.004	EM-SG-PG9-MET-C	1SNG602089R0000	50
			10	0.394									EM-SG-PG9-MET-D	1SNG602090R0000	50
PG 11	3 - 7	0.118-0.276	6	0.236	20	0.787	20	0.787	22	0.866	28	1.102	EM-SG-PG11-MET-A	1SNG602091R0000	50
			10	0.394									EM-SG-PG11-MET-B	1SNG602092R0000	50
	5 - 10	0.197-0.394	6	0.236	20	0.787	20	0.787	22	0.866	28	1.102	EM-SG-PG11-MET-C	1SNG602093R0000	50
			10	0.394									EM-SG-PG11-MET-D	1SNG602094R0000	50
PG 13.5	5 - 9	0.197-0.354	6.5	0.256	22	0.866	22	0.866	24.5	0.965	26.5	1.043	EM-SG-PG135-MET-A	1SNG602095R0000	50
			10	0.394									EM-SG-PG135-MET-B	1SNG602096R0000	50
	6 - 12	0.236-0.472	6.5	0.256	22	0.866	22	0.866	24.5	0.965	26.5	1.043	EM-SG-PG135-MET-C	1SNG602097R0000	50
			10	0.394									EM-SG-PG135-MET-D	1SNG602098R0000	50
PG 16	7 - 12	0.276-0.472	6.5	0.256	24	0.945	24	0.945	26.5	1.043	30	1.181	EM-SG-PG16-MET-A	1SNG602099R0000	25
			10	0.394									EM-SG-PG16-MET-B	1SNG602100R0000	25
	10 - 14	0.394-0.551	6.5	0.256	24	0.945	4	0.157	26.5	1.043	30	1.181	EM-SG-PG16-MET-C	1SNG602101R0000	25
			10	0.394									EM-SG-PG16-MET-D	1SNG602102R0000	25
PG 21	9 - 16	0.354-0.630	7.2	0.283	30	1.181	30	1.181	33	1.299	35	1.378	EM-SG-PG21-MET-A	1SNG602103R0000	25
			12	0.472									EM-SG-PG21-MET-B	1SNG602104R0000	25
	13 - 18	0.512-0.708	7.2	0.283	30	1.181	30	1.181	33	1.299	35	1.378	EM-SG-PG21-MET-C	1SNG602105R0000	25
			12	0.472									EM-SG-PG21-MET-D	1SNG602106R0000	25
PG 29	12 - 20	0.472-0.787	8	0.315	40	1.575	40	1.575	44.5	1.752	40.5	1.594	EM-SG-PG29-MET-A	1SNG602107R0000	10
			12	0.472									EM-SG-PG29-MET-B	1SNG602108R0000	10
	18 - 25	0.708-0.984	8	0.315	40	1.575	40	1.575	44.5	1.752	40.5	1.594	EM-SG-PG29-MET-C	1SNG602109R0000	10
			12	0.472									EM-SG-PG29-MET-D	1SNG602110R0000	10
PG 36	20 - 26	0.787-1.024	9	0.354	50	1.969	50	1.969	55.5	2.185	50	1.969	EM-SG-PG36-MET-A	1SNG602111R0000	5
			14	0.551									EM-SG-PG36-MET-B	1SNG602112R0000	5
	22 - 32	0.866-1.260	9	0.354	50	1.969	50	1.969	55.5	2.185	50	1.969	EM-SG-PG36-MET-C	1SNG602113R0000	5
			14	0.551									EM-SG-PG36-MET-D	1SNG602114R0000	5
PG 42	25 - 31	0.984-1.220	12	0.472	58	2.283	58	2.283	64	2.520	51	2.008	EM-SG-PG42-MET-A	1SNG602115R0000	5
			16	0.630									EM-SG-PG42-MET-B	1SNG602116R0000	5
	30 - 38	1.181-1.496	12	0.472	58	2.283	58	2.283	64	2.520	51	2.008	EM-SG-PG42-MET-C	1SNG602117R0000	5
			16	0.630									EM-SG-PG42-MET-D	1SNG602118R0000	5
PG 48	29 - 35	1.142-1.378	14	0.551	64	2.520	64	2.520	70	2.756	54.5	2.146	EM-SG-PG48-MET-A	1SNG602119R0000	5
			18	0.709									EM-SG-PG48-MET-B	1SNG602120R0000	5
	34 - 44	1.339-1.732	14	0.551	64	2.520	64	2.520	70	2.756	54.5	2.146	EM-SG-PG48-MET-C	1SNG602121R0000	5
			18	0.709									EM-SG-PG48-MET-D	1SNG602122R0000	5

All the main technical data provided are "manufacturer" values  
Refers to UL files for precise approval per products



# Cable Glands

Standard Cable Glands, Brass with Threads, with Locknut



## Brass cable glands with lamellar clamping

- For standard industrial applications in harsh environments
- With lamellar clamping
- Material: Body, Cap: Brass Nickel plated / Seal: CR / Clamping insert: PA 6 / O-Ring: NBR
- Ingress Protection Rating: IP 68 - 5 Bar, 30 min / IP 66
- UL Environmental Rating: TYPE 1, 4X acc. to UL 50E
- Flammability: V2 according to UL94
- Operating temperature:
  - Permanent: -20 °C to +100 °C
  - Intermittent: -40 °C to +150 °C
- Cable type: Non armoured
- Accessories (refers to dedicated page): Locknuts (Included), O-Rings (included for Metric and PG types), Washer Gaskets (for NPT type only), Dome Plugs

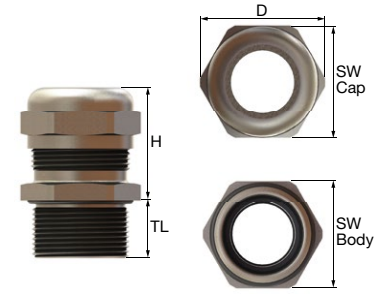

## Thread Type METRIC acc. to EN 60423

Outer Thread Size (Male)	Clamping Range Ø min - max		Outer Thread Length		Spanner Width Cap		Spanner Width Body		Outer Ø		Max. Height		Description	Part Number	Pkg per Box	
	mm	in	TL mm	TL in	mm	in	mm	in	D mm	D in	H mm	H in				
M16x1.5	2 - 6	0.079-0.236	7	0.276	17	0.669	18	0.709	20	0.787	25.5	1.004	EM-SGL-M16-MET-A	1SNG625001R0000	50	
			12	0.472										EM-SGL-M16-MET-B	1SNG625002R0000	50
	3-7	0.118-0.276	7	0.276	20	0.787	20	0.787	22	0.866	30.5	1.201	EM-SGL-M16-MET-C	1SNG625003R0000	50	
			12	0.472										EM-SGL-M16-MET-D	1SNG625004R0000	50
	4-8	0.157-0.315	7	0.276	17	0.669	18	0.709	20	0.787	25.5	1.004	EM-SGL-M16-MET-E	1SNG625005R0000	50	
			12	0.472										EM-SGL-M16-MET-F	1SNG625006R0000	50
	5-10	0.197-0.394	6.5	0.256	17	0.669	18	0.709	20	0.787	25.5	1.004	EM-SGL-M16-MET-G	1SNG625007R0000	50	
			7	0.276										EM-SGL-M16-MET-H	1SNG625008R0000	50
			12	0.472										EM-SGL-M16-MET-I	1SNG625009R0000	50
	M20x1.5	5-9	0.197-0.354	8	0.315	22	0.866	22	0.866	24.5	0.965	28	1.102	EM-SGL-M20-MET-A	1SNG625010R0000	50
				12	0.472										EM-SGL-M20-MET-B	1SNG625011R0000
6-12		0.236-0.472	8	0.315	22	0.866	22	0.866	24.5	0.965	26.5	1.043	EM-SGL-M20-MET-C	1SNG625012R0000	50	
			12	0.472										EM-SGL-M20-MET-D	1SNG625013R0000	50
7-13		0.276-0.512	8	0.315	24	0.945	24	0.945	26.5	1.043	30.5	1.201	EM-SGL-M20-MET-E	1SNG625014R0000	50	
			12	0.472										EM-SGL-M20-MET-F	1SNG625015R0000	25
10-14		0.394-0.551	8	0.315	24	0.945	24	0.945	26.5	1.043	30	1.181	EM-SGL-M20-MET-G	1SNG625016R0000	25	
			12	0.472										EM-SGL-M20-MET-H	1SNG625017R0000	25
M25x1.5		7-12	0.276-0.472	8	0.315	24	0.945	27	1.063	30	1.181	30	1.181	EM-SGL-M25-MET-A	1SNG625017R0000	25
				12	0.472										EM-SGL-M25-MET-B	1SNG625018R0000
		9-16	0.354-0.630	8	0.315	30	1.181	30	1.181	33	1.299	35	1.378	EM-SGL-M25-MET-C	1SNG625019R0000	25
				12	0.472										EM-SGL-M25-MET-D	1SNG625020R0000
	10-14	0.394-0.551	8	0.315	24	0.945	27	1.063	30	1.181	30	1.181	EM-SGL-M25-MET-E	1SNG625021R0000	25	
			12	0.472										EM-SGL-M25-MET-F	1SNG625022R0000	25
	11-17	0.433-0.669	8	0.315	27	1.063	27	1.063	30	1.181	32.5	1.280	EM-SGL-M25-MET-G	1SNG625023R0000	25	
			12	0.472										EM-SGL-M25-MET-H	1SNG625024R0000	25
	13-18	0.512-0.708	8	0.315	30	1.181	30	1.181	33	1.299	35	1.378	EM-SGL-M25-MET-I	1SNG625025R0000	25	
			12	0.472										EM-SGL-M25-MET-J	1SNG625026R0000	25
	M32x1.5	9-16	0.354-0.630	9	0.354	30	1.181	34	1.339	37.5	1.476	35	1.378	EM-SGL-M32-MET-A	1SNG625027R0000	10
				15	0.591										EM-SGL-M32-MET-B	1SNG625028R0000
12-20		0.472-0.787	9	0.354	40	1.575	40	1.575	44.5	1.752	46	1.811	EM-SGL-M32-MET-C	1SNG625029R0000	10	
			15	0.591										EM-SGL-M32-MET-D	1SNG625030R0000	10
13-18		0.512-0.708	9	0.354	30	1.181	34	1.339	37.5	1.476	35	1.378	EM-SGL-M32-MET-E	1SNG625031R0000	10	
			15	0.591										EM-SGL-M32-MET-F	1SNG625032R0000	10
15-21		0.591-0.827	8	0.315	34	1.339	34	1.339	37.5	1.476	38	1.496	EM-SGL-M32-MET-G	1SNG625033R0000	10	
			15	0.591										EM-SGL-M32-MET-H	1SNG625034R0000	10
18-25		0.708-0.984	9	0.354	40	1.575	40	1.575	44.5	1.752	46	1.811	EM-SGL-M32-MET-I	1SNG625035R0000	10	
			15	0.591										EM-SGL-M32-MET-J	1SNG625036R0000	10
M40x1.5		12-20	0.472-0.787	9	0.354	40	1.575	43	1.693	48.5	1.909	40.5	1.594	EM-SGL-M40-MET-A	1SNG625037R0000	10
				15	0.591										EM-SGL-M40-MET-B	1SNG625038R0000
	18-25	0.708-0.984	9	0.354	40	1.575	43	1.693	48.5	1.909	40.5	1.594	EM-SGL-M40-MET-C	1SNG625039R0000	10	
			15	0.591										EM-SGL-M40-MET-D	1SNG625040R0000	10
	16-23	0.630-0.906	9	0.354	43	1.693	43	1.693	48.5	1.909	45.5	1.791	EM-SGL-M40-MET-E	1SNG625041R0000	10	
			15	0.591										EM-SGL-M40-MET-F	1SNG625042R0000	10
	19-28	0.748-1.102	9	0.354	43	1.693	43	1.693	48.5	1.909	45.5	1.791	EM-SGL-M40-MET-G	1SNG625043R0000	10	
			15	0.591										EM-SGL-M40-MET-H	1SNG625044R0000	10
	22 - 32	0.866-1.260	9	0.354	50	1.969	50	1.969	55.5	2.185	54.5	2.146	EM-SGL-M40-MET-I	1SNG625045R0000	5	
			15	0.591										EM-SGL-M40-MET-J	1SNG625046R0000	5

All the main technical data provided are "manufacturer" values  
Refers to UL files for precise approval per products





# Cable Glands

Standard Cable Glands, Brass with Threads, with Locknut

## Thread Type NPT acc. to ANSI B1.20.1

Outer Thread Size (Male)	Clamping Range Ø min - max		Outer Thread Length		Spanner Width				Outer Ø		Max. Height		Description	Part Number	Pkg per Box
	mm	in	TL mm	TL in	Cap		Body		D mm	D in	H				
					SW Cap mm	SW Cap in	SW Body mm	SW Body in			H mm	H in			
NPT 1/2"	5 - 9	0.197-0.354	13	0.512	22	0.866	22	0.866	24.5	0.965	27.5	1.083	EM-SGL-NPT12-MET-A	1SNG625047R0000	50
	6 - 12	0.236-0.472	13	0.512	22	0.866	22	0.866	24.5	0.965	27.5	1.083	EM-SGL-NPT12-MET-B	1SNG625048R0000	50
	7 - 12	0.276-0.472	13	0.512	24	0.945	24	0.945	26.8	1.055	30	1.181	EM-SGL-NPT12-MET-C	1SNG625049R0000	25
	10 - 14	0.394-0.551	13	0.512	24	0.945	24	0.945	26.8	1.055	30	1.181	EM-SGL-NPT12-MET-D	1SNG625050R0000	25
NPT 3/4"	9 - 16	0.354-0.630	13	0.512	30	1.181	30	1.181	33	1.299	38	1.496	EM-SGL-NPT34-MET-A	1SNG625051R0000	25
	13 - 18	0.512-0.708	13	0.512	30	1.181	30	1.181	33	1.299	38	1.496	EM-SGL-NPT34-MET-B	1SNG625052R0000	25
NPT 1"	12 - 20	0.472-0.787	13	0.512	40	1.575	43	1.693	48.5	1.909	45.5	1.791	EM-SGL-NPT1-MET-A	1SNG625053R0000	10
	18 - 25	0.708-0.984	13	0.512	40	1.575	43	1.693	48.5	1.909	45.5	1.791	EM-SGL-NPT1-MET-B	1SNG625054R0000	10
NPT 1 1/4"	22 - 32	0.866-1.260	25.6	1.008	50	1.969	50	1.969	55.5	2.185	50	1.969	EM-SGL-NPT1 1/4-MET-A	1SNG625055R0000	5
NPT 1 1/2"	30 - 38	1.181-1.496	26	1.024	58	2.283	58	2.283	64	2.520	51	2.008	EM-SGL-NPT1 1/2-MET-A	1SNG625056R0000	5
NPT 2"	34 - 44	1.339-1.732	27	1.063	64	2.520	64	2.520	70	2.756	55	2.165	EM-SGL-NPT2-MET-A	1SNG625057R0000	5

## Thread Type PG acc. to DIN 40430

Outer Thread Size (Male)	Clamping Range Ø min - max		Outer Thread Length		Spanner Width				Outer Ø		Max. Height		Description	Part Number	Pkg per Box
	mm	in	TL mm	TL in	Cap		Body		D mm	D in	H				
					SW Cap mm	SW Cap in	SW Body mm	SW Body in			H mm	H in			
PG 9	2 - 6	0.079-0.236	6	0.236	17	0.669	17	0.669	18.9	0.744	25.5	1.004	EM-SGL-PG9-MET-A	1SNG625058R0000	50
			10	0.394										EM-SGL-PG9-MET-B	1SNG625059R0000
	4-8	0.157-0.315	6	0.236	17	0.669	17	0.669	18.9	0.744	25.5	1.004	EM-SGL-PG9-MET-C	1SNG625060R0000	50
			10	0.394										EM-SGL-PG9-MET-D	1SNG625061R0000
PG 11	3 - 7	0.118-0.276	6	0.236	20	0.787	20	0.787	22	0.866	28	1.102	EM-SGL-PG11-MET-A	1SNG625062R0000	50
			10	0.394										EM-SGL-PG11-MET-B	1SNG625063R0000
	5 - 10	0.197-0.394	6	0.236	20	0.787	20	0.787	22	0.866	28	1.102	EM-SGL-PG11-MET-C	1SNG625064R0000	50
			10	0.394										EM-SGL-PG11-MET-D	1SNG625065R0000
PG 13.5	5 - 9	0.197-0.354	6.5	0.256	22	0.866	22	0.866	24.5	0.965	26.5	1.043	EM-SGL-PG135-MET-A	1SNG625066R0000	50
			10	0.394										EM-SGL-PG135-MET-B	1SNG625067R0000
	6 - 12	0.236-0.472	6.5	0.256	22	0.866	22	0.866	24.5	0.965	26.5	1.043	EM-SGL-PG135-MET-C	1SNG625068R0000	50
			10	0.394										EM-SGL-PG135-MET-D	1SNG625069R0000
PG 16	7 - 12	0.276-0.472	6.5	0.256	24	0.945	24	0.945	26.5	1.043	30	1.181	EM-SGL-PG16-MET-A	1SNG625070R0000	25
			10	0.394										EM-SGL-PG16-MET-B	1SNG625071R0000
	10 - 14	0.394-0.551	6.5	0.256	24	0.945	4	0.157	26.5	1.043	30	1.181	EM-SGL-PG16-MET-C	1SNG625072R0000	25
			10	0.394										EM-SGL-PG16-MET-D	1SNG625073R0000
PG 21	9 - 16	0.354-0.630	7.2	0.283	30	1.181	30	1.181	33	1.299	35	1.378	EM-SGL-PG21-MET-A	1SNG625074R0000	25
			12	0.472										EM-SGL-PG21-MET-B	1SNG625075R0000
	13 - 18	0.512-0.708	7.2	0.283	30	1.181	30	1.181	33	1.299	35	1.378	EM-SGL-PG21-MET-C	1SNG625076R0000	25
			12	0.472										EM-SGL-PG21-MET-D	1SNG625077R0000
PG 29	12 - 20	0.472-0.787	8	0.315	40	1.575	40	1.575	44.5	1.752	40.5	1.594	EM-SGL-PG29-MET-A	1SNG625078R0000	10
			12	0.472										EM-SGL-PG29-MET-B	1SNG625079R0000
	18 - 25	0.708-0.984	8	0.315	40	1.575	40	1.575	44.5	1.752	40.5	1.594	EM-SGL-PG29-MET-C	1SNG625080R0000	10
			12	0.472										EM-SGL-PG29-MET-D	1SNG625081R0000

All the main technical data provided are "manufacturer" values  
Refers to UL files for precise approval per products



# Cable Glands

## Standard Snap-In Cable Glands without Threads



### Polyamide snap-in cable glands without threads

- For standard industrial applications and wall thickness of 0.5 mm to 4 mm
- Material: Body, Cap: PA 6 / Gasket & Seal: CR
- Ingress Protection Rating: IP 68 - 5 Bar, 30 min / IP 66
- UL Environmental Rating: TYPE 1, 4X acc. to UL 50E
- Flammability: V2 according to UL94
- Operating temperature:
  - Permanent: -20 °C to +100 °C
  - Intermittent: -30 °C to +150 °C
- Cable type: Non armoured
- Accessories (refers to dedicated page) : Disassembly tool (one piece included per standard package quantity), Dome Plugs

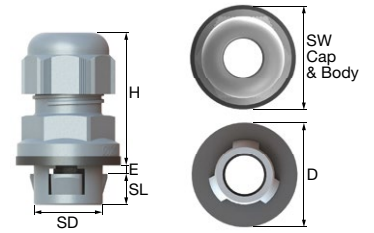

### Wall thickness (E): 0.5-4.0 mm

Snap Size	Clamping Range		Snap		Wall Hole Ø	Spanner Width		Outer Ø	Max. Height	Light grey RAL 7035		Grey RAL 7001		Black RAL 9005		Pkg per Box
	Ø min - max	Seal type	Length	Ø		Cap	Body			Description	Part Number	Description	Part Number	Description	Part Number	
	mm		mm	mm	mm	mm	mm	mm	mm							
16	3-10	Double	9	15.9	16.2-16.4	22	22	26.5	44.5	EP-SIG-SZ16-LGR-A	1SNG622001R0000	EP-SIG-SZ16-GR-A	1SNG622002R0000	EP-SIG-SZ16-BL-A	1SNG622003R0000	50
	0.118-0.394		0.354	0.626	0.638-0.646	0.866	0.866	1.043	1.752							
	5-10	Single	9	15.9	16.2-16.4	22	22	26.5	44.5	EP-SIG-SZ16-LGR-B	1SNG622004R0000	EP-SIG-SZ16-GR-B	1SNG622005R0000	EP-SIG-SZ16-BL-B	1SNG622006R0000	50
20	0.197-0.394		0.354	0.626	0.638-0.646	0.866	0.866	1.043	1.752							
	3-13	Double	9	19.9	20.2-20.4	24	24	30.3	43.5	EP-SIG-SZ20-LGR-A	1SNG622007R0000	EP-SIG-SZ20-GR-A	1SNG622008R0000	EP-SIG-SZ20-BL-A	1SNG622009R0000	50
	0.197-0.472		0.354	0.783	0.795-0.803	0.945	0.945	1.193	1.713							
25	0.118-0.512		0.354	0.783	0.795-0.803	0.984	0.984	1.193	1.713							
	3-13	Double	9	19.9	20.2-20.4	25	25	30.3	43.5	EP-SIG-SZ20-LGR-B	1SNG622010R0000	EP-SIG-SZ20-GR-B	1SNG622011R0000	EP-SIG-SZ20-BL-B	1SNG622012R0000	50
	0.236-0.472		0.354	0.783	0.795-0.803	0.945	0.945	1.193	1.713							
32	6-12	Single	9	19.9	20.2-20.4	24	24	30.3	43.5	EP-SIG-SZ20-LGR-C	1SNG622013R0000	EP-SIG-SZ20-GR-C	1SNG622014R0000	EP-SIG-SZ20-BL-C	1SNG622015R0000	50
	0.276-0.518		0.354	0.783	0.795-0.803	0.984	0.984	1.193	1.713							
	7-13	Single	9	19.9	20.2-20.4	25	25	30.3	43.5	EP-SIG-SZ20-LGR-D	1SNG622016R0000	EP-SIG-SZ20-GR-D	1SNG622017R0000	EP-SIG-SZ20-BL-D	1SNG622018R0000	50
25	0.433-0.669		0.354	0.980	0.992-1.000	1.142	1.142	1.429	1.791							
	8-17	Double	9	24.9	25.2-25.4	29	29	36.3	45.5	EP-SIG-SZ25-LGR-A	1SNG622019R0000	EP-SIG-SZ25-GR-A	1SNG622020R0000	EP-SIG-SZ25-BL-A	1SNG622021R0000	25
	0.315-0.669		0.354	0.980	0.992-1.000	1.142	1.142	1.429	1.791							
40	11-17	Single	9	24.9	25.2-25.4	29	29	36.3	45.5	EP-SIG-SZ25-LGR-B	1SNG622022R0000	EP-SIG-SZ25-GR-B	1SNG622023R0000	EP-SIG-SZ25-BL-B	1SNG622024R0000	25
	0.433-0.669		0.354	0.980	0.992-1.000	1.142	1.142	1.429	1.791							
	11-21	Double	9	31.9	32.2-32.4	36	36	43.2	51.5	EP-SIG-SZ32-LGR-A	1SNG622025R0000	EP-SIG-SZ32-GR-A	1SNG622026R0000	EP-SIG-SZ32-BL-A	1SNG622027R0000	25
32	0.433-0.827		0.354	1.256	1.268-1.276	1.417	1.417	1.701	2.028							
	15-21	Single	9	31.9	32.2-32.4	36	36	43.2	51.5	EP-SIG-SZ32-LGR-B	1SNG622028R0000	EP-SIG-SZ32-GR-B	1SNG622029R0000	EP-SIG-SZ32-BL-B	1SNG622030R0000	25
	0.591-0.827		0.354	1.256	1.268-1.276	1.417	1.417	1.701	2.028							
40	16-28	Double	13.2	39.9	40.2-40.4	46	46	55.2	58	EP-SIG-SZ40-LGR-A	1SNG622031R0000	EP-SIG-SZ40-GR-A	1SNG622032R0000	EP-SIG-SZ40-BL-A	1SNG622033R0000	20
	0.630-1.102		0.520	1.571	1.583-1.591	1.811	1.811	2.173	2.283							
	19-28	Single	13.2	39.9	40.2-40.4	46	46	55.2	58	EP-SIG-SZ40-LGR-B	1SNG622034R0000	EP-SIG-SZ40-GR-B	1SNG622035R0000	EP-SIG-SZ40-BL-B	1SNG622036R0000	20
40	0.748-1.102		0.520	1.571	1.583-1.591	1.811	1.811	2.173	2.283							

All the main technical data provided are "manufacturer" values  
Refers to UL files for precise approval per products

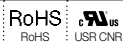

# Cable Glands

## Standard Snap-In Cable Glands without Threads



### Brass snap-in cable glands without threads

- For standard industrial applications in harsh environments and for wall thickness of 0.5 mm to 4 mm
- Material: Body, Cap: Brass Nickel plated / Seal: CR / Clamping insert: PA 6 / Lower body: CR
- Ingress Protection Rating: IP 68 - 5 Bar, 30 min / IP 66
- UL Environmental Rating: TYPE 1, 4X acc. to UL 50E
- Flammability: V2 according to UL94
- Operating temperature:
  - Permanent: -20 °C to +100 °C
  - Intermittent: -40 °C to +150 °C
- Cable type: Non armoured
- Accessories (refers to dedicated page): Disassembly tool (one piece included per minimum order quantity), Dome Plugs

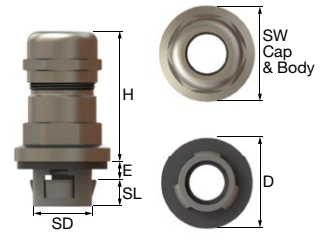

### Wall thickness (E) : 0.5-4.0 mm

Snap Size	Clamping Range		Snap Length	Ø		Wall Hole Ø		Spanner Width		Outer Ø		Max. Height		Description	Part Number	Pkg per Box				
	Ø min - max	Seal type		SL	SD	HD	SW Cap	SW Body	D	H										
	mm in		mm in	mm in	mm in	mm in	mm in	mm in	mm in	mm in	mm in	mm in								
16	3-7	0.118-0.276	Single	9	0.354	16	0.630	16.2-16.4	0.638-0.646	20	0.787	20	0.787	28.3	1.114	47	1.850	EM-SIG-SZ16-MET-A	1SNG623001R0000	10
	5-10	0.197-0.394	Single	9	0.354	16	0.630	16.2-16.4	0.638-0.646	20	0.787	20	0.787	28.3	1.114	47	1.850	EM-SIG-SZ16-MET-B	1SNG623002R0000	10
	3-10	0.118-0.394	Double	9	0.354	16	0.630	16.2-16.4	0.638-0.646	20	0.787	20	0.787	28.3	1.114	47	1.850	EM-SIG-SZ16-MET-C	1SNG623003R0000	10
20	5-9	0.197-0.354	Single	9	0.354	20	0.787	20.2-20.4	0.795-0.803	22	0.866	22	0.866	32.3	1.272	46	1.811	EM-SIG-SZ20-MET-A	1SNG623004R0000	10
	6-12	0.236-0.472	Single	9	0.354	20	0.787	20.2-20.4	0.795-0.803	22	0.866	22	0.866	32.3	1.272	46	1.811	EM-SIG-SZ20-MET-B	1SNG623005R0000	10
	5-12	0.197-0.472	Double	9	0.354	20	0.787	20.2-20.4	0.795-0.803	22	0.866	22	0.866	32.3	1.272	46	1.811	EM-SIG-SZ20-MET-C	1SNG623006R0000	10
25	9-13	0.354-0.512	Single	9	0.354	25	0.984	25.2-25.4	0.992-1.000	27	1.063	27	1.063	38.5	1.516	48	1.890	EM-SIG-SZ25-MET-A	1SNG623007R0000	10
	11-17	0.433-0.669	Single	9	0.354	25	0.984	25.2-25.4	0.992-1.000	27	1.063	27	1.063	38.5	1.516	48	1.890	EM-SIG-SZ25-MET-B	1SNG623008R0000	10
	8-17	0.315-0.669	Double	9	0.354	25	0.984	25.2-25.4	0.992-1.000	27	1.063	27	1.063	38.5	1.516	48	1.890	EM-SIG-SZ25-MET-C	1SNG623009R0000	10
32	11-15	0.433-0.591	Single	9	0.354	32	1.260	32.2-32.4	1.268-1.276	34	1.339	34	1.339	45.5	1.791	56.5	2.224	EM-SIG-SZ32-MET-A	1SNG623010R0000	5
	15-21	0.591-0.827	Single	9	0.354	32	1.260	32.2-32.4	1.268-1.276	34	1.339	34	1.339	45.5	1.791	56.5	2.224	EM-SIG-SZ32-MET-B	1SNG623011R0000	5
	11-21	0.433-0.827	Double	9	0.354	32	1.260	32.2-32.4	1.268-1.276	34	1.339	34	1.339	45.5	1.791	56.5	2.224	EM-SIG-SZ32-MET-C	1SNG623012R0000	5
40	16-23	0.630-0.906	Single	13.2	0.520	40	1.575	40.2-40.4	1.583-1.591	43	1.693	43	1.693	59	2.323	64	2.520	EM-SIG-SZ40-MET-A	1SNG623013R0000	5
	19-28	0.748-1.102	Single	13.2	0.520	40	1.575	40.2-40.4	1.583-1.591	43	1.693	43	1.693	59	2.323	64	2.520	EM-SIG-SZ40-MET-B	1SNG623014R0000	5
	16-28	0.630-1.102	Double	13.2	0.520	40	1.575	40.2-40.4	1.583-1.591	43	1.693	43	1.693	59	2.323	64	2.520	EM-SIG-SZ40-MET-C	1SNG623015R0000	5

All the main technical data provided are "manufacturer" values  
Refers to UL files for precise approval per products

RoHS  
RoHS

# Cable Glands

## Specialized RJ45 Cable Glands



### Polyamide RJ45 cable glands

- For standard industrial applications using data cables with pre-assembled RJ 45 connectors
- Material: Body, Cap: PA 6 / Seal: CR
- Ingress Protection Rating: IP 68 - 5 Bar, 30 min
- UL Environmental Rating: TYPE 1, 4X acc. to UL 50E
- Flammability: V2 according to UL94
- Operating temperature:
  - Permanent: -20 °C to +100 °C
  - Intermittent: -30 °C to +150 °C
- Cable type: Non armoured, with pre-assembled RJ 45 connector
- Accessories (refers to dedicated page): Locknuts, Washer Gaskets, Dome Plugs

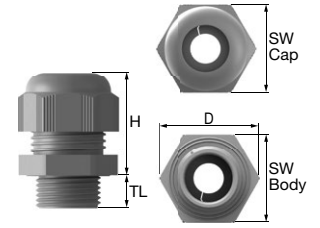

### Thread Type METRIC acc. to EN 60423

Outer Thread Size (Male)	Cable Diameter Ø	Outer Thread Length	Spanner Width		Outer Ø	Max. Height	Light grey RAL 7035 □		Grey RAL 7001 ■		Black RAL 9005 ■		Pkg
			Cap	Body			Description	Part Number	Description	Part Number	Description	Part Number	
	mm in	TL mm in	mm in	mm in	mm in	mm in							per Box
M20x1.5	6	10	27	27	30.9	31.9	EP-RJG-M20-LGR-A	1SNG618001R0000	EP-RJG-M20-GR-A	1SNG618002R0000	EP-RJG-M20-BL-A	1SNG618003R0000	50
	0.236	0.394	1.063	1.063	1.217	1.256							
	6	15					EP-RJG-M20-LGR-B	1SNG618004R0000	EP-RJG-M20-GR-B	1SNG618005R0000	EP-RJG-M20-BL-B	1SNG618006R0000	50
M25x1.5	8	8	29	29	32.5	37.7	EP-RJG-M25-LGR-A	1SNG618007R0000	EP-RJG-M25-GR-A	1SNG618008R0000	EP-RJG-M25-BL-A	1SNG618009R0000	50
	0.315	0.315	1.142	1.142	1.280	1.484							
	15	15					EP-RJG-M25-LGR-B	1SNG618010R0000	EP-RJG-M25-GR-B	1SNG618011R0000	EP-RJG-M25-BL-B	1SNG618012R0000	40
	0.591	0.591											
	10	8	33	33	37.2	38.4	EP-RJG-M25-LGR-C	1SNG618013R0000	EP-RJG-M25-GR-C	1SNG618014R0000	EP-RJG-M25-BL-C	1SNG618015R0000	25
	0.394	0.315	1.299	1.299	1.465	1.512							
15	15					EP-RJG-M25-LGR-D	1SNG618016R0000	EP-RJG-M25-GR-D	1SNG618017R0000	EP-RJG-M25-BL-D	1SNG618018R0000	20	
0.591	0.591												

### Thread Type PG acc. to DIN 40430

Outer Thread Size (Male)	Cable Diameter Ø	Outer Thread Length	Spanner Width		Outer Ø	Max. Height	Light grey RAL 7035 □		Grey RAL 7001 ■		Black RAL 9005 ■		Pkg
			Cap	Body			Description	Part Number	Description	Part Number	Description	Part Number	
	mm in	TL mm in	mm in	mm in	mm in	mm in							per Box
PG 16	6	10	27	27	30.9	31.9	EP-RJG-PG16-LGR-A	1SNG618019R0000	EP-RJG-PG16-GR-A	1SNG618020R0000	EP-RJG-PG16-BL-A	1SNG618021R0000	50
	0.236	0.394	1.063	1.063	1.217	1.256							
PG 21	6	11	33	33	37.2	38.4	EP-RJG-PG16-LGR-B	1SNG618022R0000	EP-RJG-PG16-GR-B	1SNG618023R0000	EP-RJG-PG16-BL-B	1SNG618024R0000	25
	0.236	0.433	1.299	1.299	1.465	1.512							

All the main technical data provided are "manufacturer" values  
Refers to UL files for precise approval per products

RoHS  
RoHS

UL  
USL CNL



# Cable Glands

## Specialized RJ45 Cable Glands



### Brass RJ45 cable glands

- For standard industrial applications in harsh environments, using data cables with pre-assembled RJ 45 connectors
- Material: Body, Cap: Brass Nickel plated / Seal: CR / Clamping insert: PA 6 / O-Ring: NBR
- Ingress Protection Rating: IP 68 - 5 Bar, 30 min
- UL Environmental Rating: TYPE 1, 4X acc. to UL 50E
- Flammability: V2 according to UL94
- Operating temperature:
  - Permanent: -20 °C to +100 °C
  - Intermittent: -40 °C to +150 °C
- Cable type: Non armoured, with pre-assembled RJ 45 connector
- Accessories (refers to dedicated page): Locknuts, Washer Gaskets, Dome Plugs

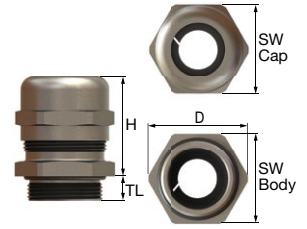

### Thread Type METRIC acc. to EN 60423

Outer Thread Size (Male)	Cable Diameter Ø		Outer Thread Length		Spanner Width				Outer Ø		Max. Height		Description	Part Number	Pkg per Box
	mm	in	mm	in	mm	in	mm	in	mm	in	mm	in			
M20x1.5	6	0.236	8	0.315	24	0.945	24	0.945	26.5	1.043	30	1.181	EM-RJG-M20-MET-A	1SNG619001R0000	50
	6	0.236	12	0.472									EM-RJG-M20-MET-B	1SNG619002R0000	50
	9	0.354	8	0.315	24	0.945	24	0.945	26.5	1.043	30	1.181	EM-RJG-M20-MET-C	1SNG619003R0000	50
	9	0.354	6	0.236									EM-RJG-M20-MET-D	1SNG619004R0000	50
M25x1.5	6	0.236	8	0.315	24	0.945	27	1.063	30	1.181	30	1.181	EM-RJG-M25-MET-A	1SNG619005R0000	25
	6	0.236	8	0.315	27	1.063	27	1.063	30	1.181	32.5	1.280	EM-RJG-M25-MET-B	1SNG619006R0000	25
	6	0.236	10	0.394	30	1.181	30	1.181	33	1.299	35	1.378	EM-RJG-M25-MET-C	1SNG619007R0000	25
	6	0.236	12	0.472	24	0.945	27	1.063	30	1.181	30	1.181	EM-RJG-M25-MET-D	1SNG619008R0000	25
	9	0.354	8	0.315	24	0.945	27	1.063	30	1.181	30	1.181	EM-RJG-M25-MET-E	1SNG619009R0000	25
M32x1.5	6	0.236	9	0.354	30	1.181	34	1.339	37.5	1.476	35	1.378	EM-RJG-M32-MET-A	1SNG619010R0000	10
M40x1.5	8	0.315	9	0.354	43	1.693	43	1.693	48.4	1.906	45.5	1.791	EM-RJG-M40-MET-A	1SNG619011R0000	5
	8	0.315	15	0.591									EM-RJG-M40-MET-B	1SNG619012R0000	5

All the main technical data provided are "manufacturer" values  
Refers to UL files for precise approval per products

RoHS RoHS	UL USL CNL														
--------------	---------------	--	--	--	--	--	--	--	--	--	--	--	--	--	--

### Thread Type PG acc. to DIN 40430

Outer Thread Size (Male)	Clamping Range Ø min - max		Outer Thread Length		Spanner Width				Outer Ø		Max. Height		Description	Part Number	Pkg per Box
	mm	in	mm	in	mm	in	mm	in	mm	in	mm	in			
PG 13.5	9	0.354	6.5	0.256	24	0.945	24	0.945	26.5	1.043	30	1.181	EM-RJG-PG135-MET-A	1SNG619013R0000	50
PG 16	6	0.236	6.5	0.256	24	0.945	24	0.945	26.5	1.043	30	1.181	EM-RJG-PG16-MET-A	1SNG619014R0000	25
	6	0.236	10	0.394									EM-RJG-PG16-MET-B	1SNG619015R0000	25
PG 21	6	0.236	7.2	0.283	30	1.181	30	1.181	33	1.299	35	1.378	EM-RJG-PG21-MET-A	1SNG619016R0000	25
	6	0.236	12	0.472									EM-RJG-PG21-MET-B	1SNG619017R0000	25

All the main technical data provided are "manufacturer" values  
Refers to UL files for precise approval per products

RoHS RoHS	UL USL CNL														
--------------	---------------	--	--	--	--	--	--	--	--	--	--	--	--	--	--

# Cable Glands

## Specialized EMC Cable Glands



### EMC2 cable glands, brass with fixed spring contact

- For industrial applications where EMC protection is needed
- Material: Body, Cap: Brass Nickel plated / Seal: CR / Clamping in Spring contact: Specific copper alloy / O-Ring: NBR
- Ingress Protection Rating: IP 68 - 5 Bar, 30 min
- UL Environmental Rating: TYPE 1, 4X acc. to UL 50E
- Flammability: V2 according to UL94
- Operating temperature:
  - Permanent: -20 °C to +100 °C
  - Intermittent: -40 °C to +150 °C
- Cable type: Shielded
- Accessories (Refers to dedicated page): Locknuts, Washer Gaskets, Dome Plugs

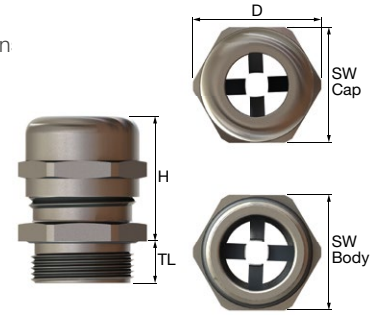

### Thread Type METRIC acc. to EN 60423

Outer Thread Size (Male)	Clamping Range Ø min - max		Shield Diameter Ø min - max		Outer Thread Length TL		Spanner Width				Outer Ø		Max. Height		Description	Part Number	Pkg per Box
							Cap		Body								
	mm	in	mm	in	mm	in	mm	in	mm	in	mm	in	mm	in			
M12x1.5	3 - 6.5	0.118-0.256	2.5 - 4.5	0.098-0.177	6	0.236	14	0.551	14	0.551	15.5	0.610	24	0.945	EM-EMC2-M12-MET-A	1SNG613001R0000	50
					12	0.472											
M16x1.5	4 - 8	0.157-0.315	3.5 - 6	0.138-0.236	7	0.276	17	0.669	18	0.709	20	0.787	25.5	1.004	EM-EMC2-M16-MET-A	1SNG613003R0000	50
					12	0.472											
M20x1.5	5 - 10	0.197-0.394	4 - 8	0.157-0.315	6.5	0.256	20	0.787	20	0.787	22	0.866	31.5	1.240	EM-EMC2-M16-MET-C	1SNG613005R0000	50
					8	0.315	22	0.866	22	0.866	24.5	0.965	26.5	1.043	EM-EMC2-M20-MET-A	1SNG613006R0000	50
M25x1.5	6 - 12	0.236-0.472	5 - 10	0.197-0.394	12	0.472									EM-EMC2-M20-MET-B	1SNG613007R0000	50
					8	0.315	24	0.945	27	1.063	30	1.181	30	1.181	EM-EMC2-M25-MET-A	1SNG613008R0000	25
M32x1.5	10 - 14	0.394-0.551	8.5 - 11.5	0.335-0.453	8	0.315	30	1.181	30	1.181	33	1.299	40	1.575	EM-EMC2-M25-MET-B	1SNG613009R0000	25
					12	0.472											EM-EMC2-M25-MET-C
M40x1.5	13 - 18	0.512-0.709	11 - 14	0.433-0.551	8	0.315	30	1.181	34	1.339	37.5	1.476	35	1.378	EM-EMC2-M32-MET-A	1SNG613011R0000	10
					15	0.591											
M50x1.5	18 - 25	0.709-0.984	16 - 20	0.63-0.787	9	0.354	40	1.575	40	1.575	44.5	1.752	46	1.811	EM-EMC2-M32-MET-C	1SNG613013R0000	10
					15	0.591	40	1.575	43	1.693	48.5	1.909	40.5	1.594	EM-EMC2-M40-MET-A	1SNG613014R0000	10
M63x1.5	22 - 32	0.866-1.26	20 - 27	0.787-1.063	9	0.354	50	1.969	50	1.969	55.5	2.185	54.5	2.146	EM-EMC2-M40-MET-B	1SNG613015R0000	10
					15	0.591	50	1.969	55	2.165	61	2.402	50	1.969	EM-EMC2-M40-MET-C	1SNG613016R0000	5
M63x1.5	34 - 44	1.339-1.732	31 - 40	1.22-1.575	9	0.354	50	1.969	55	2.165	61	2.402	50	1.969	EM-EMC2-M50-MET-A	1SNG613017R0000	5
					15	0.591	64	2.520	68	2.677	75	2.953	55	2.165	EM-EMC2-M50-MET-B	1SNG613018R0000	5
					18	0.709									EM-EMC2-M63-MET-A	1SNG613019R0000	5
															EM-EMC2-M63-MET-B	1SNG613020R0000	5

### Thread Type NPT acc. to ANSI B1.20.1

Outer Thread Size (Male)	Clamping Range Ø min - max		Shield Diameter Ø min - max		Outer Thread Length TL		Spanner Width				Outer Ø		Max. Height		Description	Part Number	Pkg per Box
							Cap		Body								
	mm	in	mm	in	mm	in	mm	in	mm	in	mm	in	mm	in			
NPT 3/8"	5 - 10	0.197-0.394	4 - 8	0.157-0.315	11.5	0.453	20	0.787	20	0.787	22	0.866	31.5	1.240	EM-EMC2-NPT38-MET-A	1SNG613021R0000	50
NPT 1/2"	6 - 12	0.236-0.472	5 - 10	0.197-0.394	13	0.512	22	0.866	22	0.866	24.5	0.965	27.5	1.083	EM-EMC2-NPT12-MET-A	1SNG613022R0000	50
NPT 3/4"	13 - 18	0.512-0.709	11 - 14	0.433-0.551	13	0.512	30	1.181	30	1.181	33	1.299	38	1.496	EM-EMC2-NPT34-MET-A	1SNG613023R0000	25
NPT 1"	18 - 25	0.709-0.984	16 - 20	0.63-0.787	13	0.512	40	1.575	43	1.693	48.5	1.909	45.5	1.791	EM-EMC2-NPT1-MET-A	1SNG613024R0000	10

All the main technical data provided are "manufacturer" values  
Refers to UL files for precise approval per products

RoHS	USR CNR	USL CNL															
------	---------	---------	--	--	--	--	--	--	--	--	--	--	--	--	--	--	--

# Cable Glands

## Specialized EMC Cable Glands

### Thread Type PG acc. to DIN 40430

Outer Thread Size (Male)	Clamping Range Ø		Shield Diameter Ø		Outer Thread Length		Spanner Width				Outer Ø		Max. Height		Description	Part Number	Pkg per Box
	min - max		min - max		TL		Cap		Body		D		H				
	mm	in	mm	in	mm	in	mm	in	mm	in	mm	in	mm	in			
PG 7	3 - 6.5	0.118-0.256	2.5 - 4.5	0.098-0.177	6	0.236	14	0.551	14	0.551	15.5	0.610	24	0.945	EM-EMC2-PG7-MET-A	1SNG613025R0000	50
					10	0.394									EM-EMC2-PG7-MET-B	1SNG613026R0000	50
PG 9	4 - 8	0.157-0.315	3.5 - 6	0.138-0.236	6	0.236	17	0.669	17	0.669	18.9	0.744	25.5	1.004	EM-EMC2-PG9-MET-A	1SNG613027R0000	50
					10	0.394									EM-EMC2-PG9-MET-B	1SNG613028R0000	50
PG 11	5 - 10	0.197-0.394	4 - 8	0.157-0.315	6	0.236	20	0.787	20	0.787	22	0.866	28	1.102	EM-EMC2-PG11-MET-A	1SNG613029R0000	50
					10	0.394									EM-EMC2-PG11-MET-B	1SNG613030R0000	50
PG 13.5	6 - 12	0.236-0.472	5 - 10	0.197-0.394	6.5	0.256	22	0.866	22	0.866	24.5	0.965	26.5	1.043	EM-EMC2-PG135-MET-A	1SNG613031R0000	50
					10	0.394									EM-EMC2-PG135-MET-B	1SNG613032R0000	50
PG 16	10 - 14	0.394-0.551	8.5 - 11.5	0.335-0.453	6.5	0.256	24	0.945	24	0.945	26.5	1.043	30	1.181	EM-EMC2-PG16-MET-A	1SNG613033R0000	25
					10	0.394									EM-EMC2-PG16-MET-B	1SNG613034R0000	25
PG 21	13 - 18	0.512-0.709	11 - 14	0.433-0.551	7.2	0.283	30	1.181	30	1.181	33	1.299	35	1.378	EM-EMC2-PG21-MET-A	1SNG613035R0000	25
					12	0.472									EM-EMC2-PG21-MET-B	1SNG613036R0000	25
PG 29	18 - 25	0.709-0.984	16 - 20	0.63-0.787	8	0.315	40	1.575	40	1.575	44.5	1.752	40.5	1.594	EM-EMC2-PG29-MET-A	1SNG613037R0000	10
					12	0.472									EM-EMC2-PG29-MET-B	1SNG613038R0000	10
PG 36	22 - 32	0.866-1.26	20 - 27	0.787-1.063	9	0.354	50	1.969	50	1.969	55.5	2.185	50	1.969	EM-EMC2-PG36-MET-A	1SNG613039R0000	5
					14	0.551									EM-EMC2-PG36-MET-B	1SNG613040R0000	5
PG 42	30 - 38	1.181-1.496	28 - 34	1.102-1.339	12	0.472	58	2.283	58	2.283	64	2.520	51	2.008	EM-EMC2-PG42-MET-A	1SNG613041R0000	5
					16	0.630									EM-EMC2-PG42-MET-B	1SNG613042R0000	5
PG 48	34 - 44	1.339-1.732	31 - 40	1.22-1.575	14	0.551	64	2.520	64	2.520	70	2.756	55	2.165	EM-EMC2-PG48-MET-A	1SNG613043R0000	5
					18	0.709									EM-EMC2-PG48-MET-B	1SNG613044R0000	5

All the main technical data provided are "manufacturer" values  
Refers to UL files for precise approval per products



# Cable Glands

## Specialized EMC Cable Glands



### EMC4 cable glands, brass with moving spring contact

- For industrial applications where EMC protection is needed
- Vibration proof
- Material: Body, Cap: Brass Nickel plated / Seal: CR / Clamping in Spring contact: Specific copper alloy / O-Ring: NBR
- Ingress Protection Rating: IP 68 - 5 Bar, 30 min
- UL Environmental Rating: TYPE 4X, 12, 13 acc. to UL 50E
- Flammability: V2 according to UL94
- Operating temperature:
  - Permanent: -20 °C to +100 °C
  - Intermittent: -40 °C to +150 °C
- Cable type: Shielded
- Accessories (Refers to dedicated page): Locknuts, Washer Gaskets, Dome Plugs

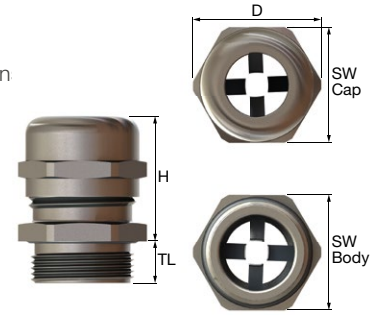

### Thread Type METRIC acc. to EN 60423

Outer Thread Size (Male)	Clamping Range Ø		Shield Diameter Ø		Outer Thread Length		Spanner Width				Outer Ø		Max. Height		Pkg per Box		
	min - max		min - max		TL		Cap		Body		D		H				
	mm	in	mm	in	mm	in	mm	in	mm	in	mm	in	mm	in			
M12x1.5	3 - 6.5	0.118-0.256	2 - 5	0.079-0.197	6	0.236	14	0.551	14	0.551	15.5	0.610	30	1.181	EM-EMC4-M12-MET-A	1SNG614001R0000	50
M16x1.5	5 - 10	0.197-0.394	3.5 - 8	0.138-0.315	6	0.236	20	0.787	20	0.787	22	0.866	35	1.378	EM-EMC4-M16-MET-A	1SNG614002R0000	50
M20x1.5	6 - 12	0.236-0.472	4.5 - 10	0.177-0.394	6	0.236	22	0.866	22	0.866	24.5	0.965	33.5	1.319	EM-EMC4-M20-MET-A	1SNG614003R0000	50
	7.5 - 14	0.295-0.551	5.5 - 11.5	0.217-0.453	8	0.315	24	0.945	24	0.945	26.8	1.055	41.5	1.634	EM-EMC4-M20-MET-B	1SNG614004R0000	50
M25x1.5	10 - 18	0.394-0.709	7 - 14	0.276-0.551	8	0.315	30	1.181	30	1.181	33	1.299	44.5	1.752	EM-EMC4-M25-MET-A	1SNG614005R0000	25
M32x1.5	16 - 25	0.63-0.984	12 - 20	0.472-0.787	9	0.354	40	1.575	40	1.575	44.5	1.752	55	2.165	EM-EMC4-M32-MET-A	1SNG614006R0000	10
M40x1.5	22 - 32	0.866-1.26	18 - 27	0.709-1.063	9	0.354	50	1.969	50	1.969	55.5	2.185	62.5	2.461	EM-EMC4-M40-MET-A	1SNG614007R0000	5
M50x1.5	30 - 38	1.181-1.496	26 - 34	1.024-1.339	9	0.354	58	2.283	58	2.283	64	2.520	74	2.913	EM-EMC4-M50-MET-A	1SNG614008R0000	5
M63x1.5	34 - 44	1.339-1.732	30 - 40	1.181-1.575	14	0.551	64	2.520	68	2.677	75	2.953	60	2.362	EM-EMC4-M63-MET-A	1SNG614009R0000	5
	37 - 53	1.457-2.087	33 - 49	1.299-1.929	10	0.394	75	2.953	75	2.953	83	3.268	75	2.953	EM-EMC4-M63-MET-B	1SNG614010R0000	5

### Thread Type NPT acc. to ANSI B1.20.1

Outer Thread Size (Male)	Clamping Range Ø		Shield Diameter Ø		Outer Thread Length		Spanner Width				Outer Ø		Max. Height		Pkg per Box		
	min - max		min - max		TL		Cap		Body		D		H				
	mm	in	mm	in	mm	in	mm	in	mm	in	mm	in	mm	in			
NPT 1/4"	3 - 6.5	0.118-0.256	2 - 5	0.079-0.197	11.5	0.453	14	0.551	15	0.591	16.5	0.650	30	1.181	EM-EMC4-NPT14-MET-A	1SNG614011R0000	50
NPT 3/8"	5 - 10	0.197-0.394	3.5 - 8	0.138-0.315	11.5	0.453	20	0.787	20	0.787	22	0.866	35	1.378	EM-EMC4-NPT38-MET-A	1SNG614012R0000	50
NPT 1/2"	6 - 12	0.236-0.472	4.5 - 10	0.177-0.394	15	0.591	22	0.866	22	0.866	24.5	0.965	39.5	1.555	EM-EMC4-NPT12-MET-A	1SNG614013R0000	50
	7.5 - 14	0.295-0.551	5.5 - 11.5	0.217-0.453	15	0.591	24	0.945	24	0.945	26.8	1.055	41.5	1.634	EM-EMC4-NPT12-MET-B	1SNG614014R0000	50
NPT 3/4"	10 - 18	0.394-0.709	7 - 14	0.276-0.551	15	0.591	30	1.181	30	1.181	33	1.299	43.5	1.713	EM-EMC4-NPT34-MET-A	1SNG614015R0000	25
NPT 1"	16 - 25	0.63-0.984	12 - 20	0.472-0.787	20	0.787	40	1.575	40	1.575	44.5	1.752	54	2.126	EM-EMC4-NPT1-MET-A	1SNG614016R0000	25
NPT 1 1/4"	22 - 32	0.866-1.26	18 - 27	0.709-1.063	20	0.787	50	1.969	50	1.969	55.5	2.185	63	2.480	EM-EMC4-NPT114-MET-A	1SNG614017R0000	20
NPT 1 1/2"	30 - 38	1.181-1.496	26 - 34	1.024-1.339	22	0.866	58	2.283	58	2.283	64	2.520	73	2.874	EM-EMC4-NPT112-MET-A	1SNG614018R0000	10
NPT 2"	34 - 44	1.339-1.732	30 - 40	1.181-1.575	22	0.866	64	2.520	68	2.677	75	2.953	73	2.874	EM-EMC4-NPT2-MET-A	1SNG614019R0000	5

### Thread Type PG acc. to DIN 40430

Outer Thread Size (Male)	Clamping Range Ø		Shield Diameter Ø		Outer Thread Length		Spanner Width				Outer Ø		Max. Height		Pkg per Box		
	min - max		min - max		TL		Cap		Body		D		H				
	mm	in	mm	in	mm	in	mm	in	mm	in	mm	in	mm	in			
PG 7	3 - 6.5	0.118-0.256	2 - 5	0.079-0.197	6	0.236	14	0.551	15	0.591	16.5	0.650	30	1.181	EM-EMC4-PG7-MET-A	1SNG614020R0000	50
PG 9	4 - 8	0.157-0.315	2.5 - 6	0.098-0.236	6	0.236	17	0.669	17	0.669	18.9	0.744	33.8	1.331	EM-EMC4-PG9-MET-A	1SNG614021R0000	50
PG 11	5 - 10	0.197-0.394	3.5 - 8	0.138-0.315	6	0.236	20	0.787	21	0.827	23	0.906	35	1.378	EM-EMC4-PG11-MET-A	1SNG614022R0000	50
PG 13.5	6 - 12	0.236-0.472	4.5 - 10	0.177-0.394	6.5	0.256	22	0.866	22	0.866	24.5	0.965	33.5	1.319	EM-EMC4-PG135-MET-A	1SNG614023R0000	50
PG 16	7.5 - 14	0.295-0.551	5.5 - 11.5	0.217-0.453	6.5	0.256	24	0.945	25	0.984	27.5	1.083	41.5	1.634	EM-EMC4-PG16-MET-A	1SNG614024R0000	25
PG 21	10 - 18	0.394-0.709	7 - 14	0.276-0.551	7	0.276	30	1.181	32	1.260	35.5	1.398	44.5	1.752	EM-EMC4-PG21-MET-A	1SNG614025R0000	25
PG 29	16 - 25	0.63-0.984	12 - 20	0.472-0.787	9	0.354	40	1.575	40	1.575	44.5	1.752	55	2.165	EM-EMC4-PG29-MET-A	1SNG614026R0000	10
PG 36	22 - 32	0.866-1.26	18 - 27	0.709-1.063	9	0.354	50	1.969	50	1.969	55.5	2.185	62	2.441	EM-EMC4-PG36-MET-A	1SNG614027R0000	5
PG 42	30 - 38	1.181-1.496	26 - 34	1.024-1.339	12	0.472	58	2.283	60	2.362	66.5	2.618	74.5	2.933	EM-EMC4-PG42-MET-A	1SNG614028R0000	5
PG 48	34 - 44	1.339-1.732	30 - 40	1.181-1.575	14	0.551	64	2.520	68	2.677	75	2.953	60.5	2.382	EM-EMC4-PG48-MET-A	1SNG614029R0000	5

All the main technical data provided are "manufacturer" values  
Refers to UL files for precise approval per products





# Cable Glands

## Specialized EMC Cable Glands



### EMC4 cable glands for railway applications, brass with moving spring contact

- For railway applications
- EMC protection
- Vibration proof
- Material: Body, Cap: Brass Nickel plated / Seal: EPDM / Clamping insert: PA 6 / Spring contact: Specific copper alloy / O-Ring: EPDM
- Ingress Protection Rating: IP 68 - 5 Bar, 30 min / IP66
- Flammability: R22 R23 HL2 HL3 acc. To EN45545-2
- Operating temperature:
  - Permanent: -40 °C to +100 °C
- Accessories (Refers to dedicated page): Locknuts

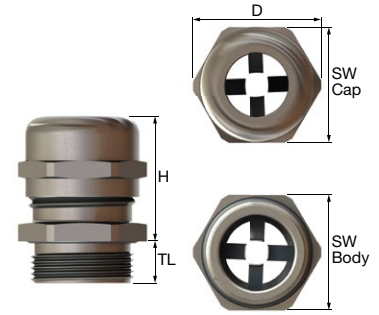

### Thread Type METRIC acc. to EN 60423

Outer Thread Size (Male)	Clamping Range Ø min-max		Shield Diameter Ø min-max		Outer Thread Length		Spanner Width				Outer Ø		Max. Height		Description	Part Number	Pkg per Box
	mm	in	mm	in	mm	in	mm	in	mm	in	mm	in	mm	in			
<b>M12x1.5</b>	3 - 6.5	0.118-0.256	2 - 5	0.079-0.197	6	0.236	14	0.551	14	0.551	15.5	0.610	30	1.181	EM-RG-M12-MET-A	<b>1SNG606001R0000</b>	50
<b>M16x1.5</b>	5 - 10	0.197-0.394	3.5 - 8	0.138-0.315	6	0.236	20	0.787	20	0.787	22	0.866	35	1.378	EM-RG-M16-MET-A	<b>1SNG606002R0000</b>	50
<b>M20x1.5</b>	6 - 12	0.236-0.472	4.5 - 10	0.177-0.394	6	0.236	22	0.866	22	0.866	24.5	0.965	33.5	1.319	EM-RG-M20-MET-A	<b>1SNG606003R0000</b>	50
	7.5 - 14	0.295-0.551	5.5 - 11.5	0.217-0.453	8	0.315	24	0.945	24	0.945	26.8	1.055	41.5	1.634	EM-RG-M20-MET-B	<b>1SNG606004R0000</b>	50
<b>M25x1.5</b>	10 - 18	0.394-0.709	7 - 14	0.276-0.551	8	0.315	30	1.181	30	1.181	33	1.299	44.5	1.752	EM-RG-M25-MET-A	<b>1SNG606005R0000</b>	50
<b>M32x1.5</b>	16 - 25	0.63-0.984	12 - 20	0.472-0.787	9	0.354	40	1.575	40	1.575	44.5	1.752	55	2.165	EM-RG-M32-MET-A	<b>1SNG606006R0000</b>	50
<b>M40x1.5</b>	22 - 32	0.866-1.26	18 - 27	0.709-1.063	9	0.354	50	1.969	50	1.969	55.5	2.185	62.5	2.461	EM-RG-M40-MET-A	<b>1SNG606007R0000</b>	50

All the main technical data provided are "manufacturer" values

RoHS  
RoHS

# Cable Glands

## Specialized Hygienic Cable Glands



### Hygienic cable glands, stainless steel 303

- For applications in manufacturing and packaging of food and pharmaceuticals, cleanroom technology, biotechnology, chemical industry
- Material: Body, Cap, Locknut: Stainless Steel 1.4305 (AISI 303) / Seal: EPDM, acc. to FDA guideline 21 CFR 177.2600
- Ingress Protection Rating: IP 68 - 5 Bar, 30 min / IP66 / IP69
- UL Environmental Rating: TYPE 1, 2, 4, 4X, 12, 12K, 13 acc. to UL 50E
- Operating temperature:
  - Permanent: -20 °C to +100 °C
  - Intermittent: -40 °C to +150 °C
- Cable type: Non-armoured
- Locknut included
- Accessories: Hygienic Cable Gland Adapters

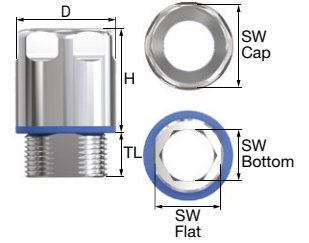

### Thread Type METRIC acc. to EN 60423

Outer Thread Size (Male)	Clamping Range Ø min-max		Outer Thread Length		Spanner Width				Allen Screw		Outer Ø		Max. Height		Spanner Width Locknut		Description	Part Number	Pkg per Box
	mm	in	TL mm	in	Cap		Flat		SW Bottom		D mm	in	H mm	in	SW				
					mm	in	mm	in	mm	in					mm	in			
M12x1.5	3 - 6.5	0.118-0.256	6	0.236	14	0.551	10	0.394	7	0.276	15.6	0.614	23.5	0.925	15	0.591	EM-HG-M12-MET-A	1SNG615001R0000	5
M16x1.5	5 - 10	0.197-0.394	7	0.276	18	0.709	13	0.512	10	0.394	20.2	0.795	26.5	1.043	19	0.748	EM-HG-M16-MET-A	1SNG615002R0000	5
M20x1.5	6 - 12	0.236-0.472	8	0.315	22	0.866	17	0.669	13	0.512	24.1	0.949	29.5	1.161	24	0.945	EM-HG-M20-MET-A	1SNG615003R0000	5
M25x1.5	12 - 17	0.472-0.669	10	0.394	28	1.102	22	0.866	17	0.669	30.1	1.185	32.5	1.280	30	1.181	EM-HG-M25-MET-A	1SNG615004R0000	5

### Thread Type NPT acc. to ANSI ASME B1.20.1

Outer Thread Size (Male)	Clamping Range Ø min-max		Outer Thread Length		Spanner Width				Allen Screw		Outer Ø		Max. Height		Spanner Width Locknut		Description	Part Number	Pkg per Box
	mm	in	TL mm	in	Cap		Flat		SW Bottom		D mm	in	H mm	in	SW				
					mm	in	mm	in	mm	in					mm	in			
NPT 1/4"	3 - 6.5	0.118-0.256	10	0.394	18	0.709	10	0.394	7	0.276	20.2	0.795	23.5	0.925	17	0.669	EM-HG-NPT14-MET-A	1SNG615005R0000	5
NPT 3/8"	5 - 10	0.197-0.394	10	0.394	22	0.866	13	0.512	10	0.394	24.1	0.949	27.5	1.083	24	0.945	EM-HG-NPT38-MET-A	1SNG615006R0000	5
NPT 1/2"	6 - 12	0.236-0.472	11	0.433	28	1.102	17	0.669	13	0.512	30.1	1.185	30.5	1.201	24	0.945	EM-HG-NPT12-MET-A	1SNG615007R0000	5
NPT 3/4"	12 - 17	0.472-0.669	12	0.472	35	1.378	22	0.866	17	0.669	38	1.496	33.5	1.319	35	1.378	EM-HG-NPT34-MET-A	1SNG615008R0000	5

### Hygienic cable gland adapters

- To reduce Allen screw SW Bottom to Allen screw SW a
- Material Stainless Steel 1.4305(AISI 303)

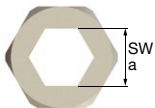

### Adapters

For Gland Size	Allen Screw SW a		Description	Part Number	Pkg per Box
	mm	in			
M12, NPT 1/4"	5	0.197	EM-HG-SZ1-MET-A	1SNG615009R0000	5
M16, NPT 3/8"	6	0.236	EM-HG-SZ2-MET-A	1SNG615010R0000	5
M20, NPT 1/2"	8	0.315	EM-HG-SZ3-MET-A	1SNG615011R0000	5
M25, NPT 3/4"	10	0.394	EM-HG-SZ4-MET-A	1SNG615012R0000	5

All the main technical data provided are "manufacturer" values  
Refers to UL files for precise approval per products

RoHS	USR CNR	USL CNL																	
------	---------	---------	--	--	--	--	--	--	--	--	--	--	--	--	--	--	--	--	--

# Cable Glands

## Specialized Hygienic Cable Glands



### Hygienic EMC cable glands, stainless steel 303

- For applications in manufacturing and packaging of food and pharmaceuticals, cleanroom technology, biotechnology, chemical industry
- EMC protection
- Material: Body, Cap, Locknut : Stainless Steel 1.4305(AISI 303) / Spring contact: specific copper alloy / Seal: EPDM, acc. to FDA guideline 21 CFR 177.2600
- Ingress Protection Rating: IP 68 - 5 Bar, 30 min / IP66 / IP69
- UL Environmental Rating: TYPE 1, 2, 4, 4X, 12, 12K, 13 acc. to UL 50E
- Operating temperature:
  - Permanent: -20 °C to +100 °C
  - Intermittent: -40 °C to +150 °C
- Cable type: Shielded
- EMC locknut included
- Accessories: Hygienic Cable Gland Adapters

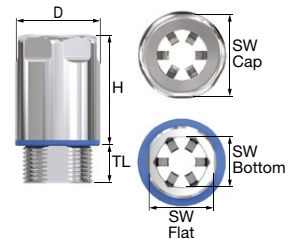

### Thread Type METRIC acc. to EN 60423

Outer Thread Size (Male)	Clamping Range Ø min-max		Shield Ø min-max		Outer Thread Length TL		Spanner Width Cap SW Cap		Spanner Width Flat SW Flat		Allen Screw SW Bottom		Outer Ø D		Max. Height H		Spanner Width Locknut SW		Description	Part Number	Pkg per Box
	mm	in	mm	in	mm	in	mm	in	mm	in	mm	in	mm	in	mm	in	mm	in			
M16x1.5	5 - 10	0.197-0.394	4 - 9	0.157-0.354	7	0.276	18	0.709	13	0.512	10	0.394	20.2	0.795	32.5	1.280	19	0.748	EM-HEMC-M16-MET-A	1SNG617001R0000	5
M20x1.5	6 - 12	0.236-0.472	5 - 11	0.197-0.433	8	0.315	22	0.866	17	0.669	13	0.512	24.1	0.949	35.5	1.398	24	0.945	EM-HEMC-M20-MET-A	1SNG617002R0000	5
M25x1.5	12 - 17	0.472-0.669	10 - 16	0.394-0.63	10	0.394	28	1.102	22	0.866	17	0.669	30.1	1.185	41	1.614	30	1.181	EM-HEMC-M25-MET-A	1SNG617003R0000	5

### Thread Type NPT acc. to ANSI ASME B1.20.1

Outer Thread Size (Male)	Clamping Range Ø min-max		Shield Ø min-max		Outer Thread Length TL		Spanner Width Cap SW Cap		Spanner Width Flat SW Flat		Allen Screw SW Bottom		Outer Ø D		Max. Height H		Spanner Width Locknut SW		Description	Part Number	Pkg per Box
	mm	in	mm	in	mm	in	mm	in	mm	in	mm	in	mm	in	mm	in	mm	in			
NPT 3/8"	5 - 10	0.197-0.394	4 - 9	0.157-0.354	10	0.394	22	0.866	13	0.512	10	0.394	24.1	0.949	33	1.299	22	0.866	EM-HEMC-NPT38-MET-A	1SNG617004R0000	5
NPT 1/2"	6 - 12	0.236-0.472	5 - 11	0.197-0.433	11	0.433	28	1.102	17	0.669	13	0.512	30.1	1.185	36	1.417	24	0.945	EM-HEMC-NPT12-MET-A	1SNG617005R0000	5
NPT 3/4"	12 - 17	0.472-0.669	10 - 16	0.394-0.63	12	0.472	35	1.378	22	0.866	17	0.669	38	1.496	41.5	1.634	30	1.181	EM-HEMC-NPT34-MET-A	1SNG617006R0000	5

### Hygienic cable gland adapters

- To reduce Allen screw SW Bottom to Allen screw SW a
- Material Stainless Steel 1.4305(AISI 303)

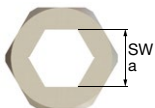

### Adapters

For Gland Size	Allen Screw SW a		Description	Part Number	Pkg per Box
	mm	in			
M16, NPT 3/8"	6	0.236	EM-HG-SZ2-MET-A	1SNG615010R0000	5
M20, NPT 1/2"	8	0.315	EM-HG-SZ3-MET-A	1SNG615011R0000	5
M25, NPT 3/4"	10	0.394	EM-HG-SZ4-MET-A	1SNG615012R0000	5

All the main technical data provided are "manufacturer" values  
Refers to UL files for precise approval per products

RoHS	USR CNR	USL CNL																			
------	---------	---------	--	--	--	--	--	--	--	--	--	--	--	--	--	--	--	--	--	--	--

# Cable Glands

## Specialized Hygienic Conduit Fittings



### Hygienic conduit fittings, stainless steel 303

- For conduits in manufacturing and packaging of food and pharmaceuticals, cleanroom technology, biotechnology, chemical industry
- EMC protection
- Material: Body, Cap, Locknut: Stainless Steel 1.4305(AISI 303) / Seal: TPE, acc. to FDA guideline 21 CFR 177.1210 / Pressure Ring: PA6 / O-ring: NBR / Ferrule: Brass
- Ingress Protection Rating: IP 65 / IP66
- UL Environmental Rating: TYPE 1, 2, 4, 4X, 12, 12K, 13 acc. to UL 50E
- Operating temperature:
  - Permanent: -20 °C to +100 °C
  - Intermittent: -40 °C to +150 °C
- Locknut included
- Accessories: Tightening Tools

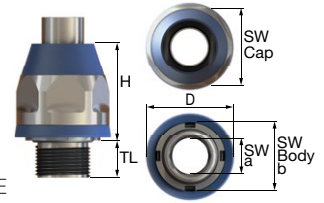

### Thread Type METRIC acc. to EN 60423

Outer Thread Size (Male)	For Sealrite Nominal Size	Outer Thread Length		Spanner Width		Allen Screw		Crescent Wrench		Outer Ø		Max. Height		Spanner Width Locknut		Description	Part Number	Pkg per Box
		TL	mm	in	mm	in	mm	in	mm	in	mm	in	mm	in	mm			
M16x1.5	3/8"	11.5	0.453	27	1.063	11	0.433	24	0.945	31.1	1.224	39	1.535	19	0.748	EM-HCF-M16-MET-A	1SNG616001R0000	5
M20x1.5	1/2"	13	0.512	30	1.181	14	0.551	27	1.063	34	1.339	39.5	1.555	24	0.945	EM-HCF-M20-MET-A	1SNG616002R0000	5
M25x1.5	3/4"	15	0.591	36	1.417	19	0.748	33	1.299	41	1.614	44.5	1.752	30	1.181	EM-HCF-M25-MET-A	1SNG616003R0000	5
M32x1.5	1"	15	0.591	46	1.811	25	0.984	42	1.654	52.7	2.075	53.5	2.106	36	1.417	EM-HCF-M32-MET-A	1SNG616004R0000	5
M40x1.5	1 1/4"	16	0.630	54	2.126	32	1.260	50	1.969	62	2.441	61.5	2.421	46	1.811	EM-HCF-M40-MET-A	1SNG616005R0000	5
M50x1.5	1 1/2"	18	0.709	63	2.480	36	1.417	58	2.283	70	2.756	65.5	2.579	60	2.362	EM-HCF-M50-MET-A	1SNG616006R0000	5
M63x1.5	2"	20	0.787	77	3.031	48	1.890	72	2.835	84.6	3.331	70.5	2.776	70	2.756	EM-HCF-M63-MET-A	1SNG616007R0000	5

### Thread Type NPT acc. to ANSI ASME B1.20.1

Outer Thread Size (Male)	For Sealrite Nominal Size	Outer Thread Length		Spanner Width		Allen Screw		Crescent Wrench		Outer Ø		Max. Height		Spanner Width Locknut		Description	Part Number	Pkg per Box
		TL	mm	in	mm	in	mm	in	mm	in	mm	in	mm	in	mm			
NPT 3/8"	3/8"	15.3	0.602	27	1.063	11	0.433	24	0.945	31.1	1.224	39	1.535	24	0.945	EM-HCF-NPT38-MET-A	1SNG616008R0000	5
NPT 1/2"	1/2"	19.9	0.783	30	1.181	14	0.551	27	1.063	34	1.339	39.5	1.555	24	0.945	EM-HCF-NPT12-MET-A	1SNG616009R0000	5
NPT 3/4"	3/4"	20.2	0.795	36	1.417	19	0.748	33	1.299	41	1.614	44.5	1.752	35	1.378	EM-HCF-NPT34-MET-A	1SNG616010R0000	5
NPT 1"	1"	25	0.984	46	1.811	24	0.945	42	1.654	52.7	2.075	53.5	2.106	46	1.811	EM-HCF-NPT1-MET-A	1SNG616011R0000	5
NPT 1 1/4"	1 1/4"	25.6	1.008	54	2.126	31	1.220	50	1.969	62	2.441	61.5	2.421	55	2.165	EM-HCF-NPT14-MET-A	1SNG616012R0000	5
NPT 1 1/2"	1 1/2"	26	1.024	63	2.480	36	1.417	58	2.283	70	2.756	65.5	2.579	60	2.362	EM-HCF-NPT12-MET-A	1SNG616013R0000	5
NPT 2"	2"	26.9	1.059	77	3.031	46	1.811	72	2.835	84.6	3.331	70.5	2.776	74	2.913	EM-HCF-NPT2-MET-A	1SNG616014R0000	5



### Hygienic conduit fitting tightening tools

- Recommended tools

### Tightening Tools

For Fitting Size	Allen Screw		Crescent Wrench	
	SW a		SW Body b	
	mm	in	mm	in
M16, NPT 3/8"	11	0,433	24	0,945
M20, NPT 1/2"	14	0,551	27	1,063
M25, NPT 3/4"	19	0,748	33	1,299
NPT 1"	24	0,945	42	1,654
M32	25	0,984	42	1,654
NPT 1 1/4"	31	1,220	50	1,969
M40	32	1,260	50	1,969
M50	36	1,417	58	2,283
NPT 2"	46	1,811	72	2,835
M63	48	1,890	72	2,835

All the main technical data provided are "manufacturer" values  
Refers to UL files for precise approval per products







# Cable Entry Plates

## Standard Cable Entry Plates



### BPA cable plates

- For standard industrial applications, to be used instead of standard cable glands, when the space on the enclosure is limited and also as an economical solution
- The cable entry plates are designed for connectorised and non-connectorised cables.
- Material:
  - Frames, Plates and Inserts: PA Glass Fibre reinforced
  - Clamping Seals: CR
  - Main Frame Seal: Polyurethane
  - Screws, Locknut: Steel / Washers (Screws): NBR
- Ingress Protection Rating: Type 12,13 / Type 4X / IP66
- Flammability: HB According to UL94
- Operating temperature: -40 °C to +80 °C

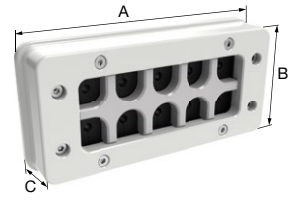

### Plates

No. of Cable Entries	Seal Quantity per Frame	Frame Width A		Height B		Depth C		Light grey RAL 7035		Black RAL 9005		Pkg per Box
		mm	in	mm	in	mm	in	Description	Part Number	Description	Part Number	
4 (2B+2A)	2 small (type A) 2 large (type B)	156.5	6.161	75.5	2.972	27.5	1.083	EP-BPA-SZ4-LGR-A	1SNG604001R0000	EP-BPA-SZ4-BL-A	1SNG604002R0000	1
7 (1B+6A)	6 small (type A) 1 large (type B)	156.5	6.161	75.5	2.972	27.5	1.083	EP-BPA-SZ7-LGR-A	1SNG604003R0000	EP-BPA-SZ7-BL-A	1SNG604004R0000	1
10 (0B+10A)	10 small (type A)	156.5	6.161	75.5	2.972	27.5	1.083	EP-BPA-SZ10-LGR-A	1SNG604005R0000	EP-BPA-SZ10-BL-A	1SNG604006R0000	1

### Onion Seals

Seal Size	Related Onion Seal	Central Ø After Peeling		Cable Clamping Range Ø		Description	Part Number	Pkg per Box
		mm	in	mm	in			
A1	01-Ø4/Ø5	1	0.039	3.5 to 5.5	0.138-0.217	EP-BPA-SZ1-BL-A	1SNG604007R0000	500
	02-Ø6/Ø7	2	0.079	5.5 to 7.5	0.217-0.295			
	03-Ø8/Ø9	3	0.118	7.5 to 9.5	0.295-0.374			
A2	01-Ø10/Ø11	1	0.039	9.5 to 11.5	0.374-0.453	EP-BPA-SZ2-BL-A	1SNG604008R0000	500
	02-Ø12/Ø13	2	0.079	11.5 to 13.5	0.453-0.531			
	03-Ø14/Ø15	3	0.118	13.5 to 15.5	0.531-0.610			
B1	01-Ø16/Ø17	1	0.039	15.5 to 17.5	0.610-0.689	EP-BPA-SZ3-BL-A	1SNG604009R0000	300
	02-Ø18/Ø19	2	0.079	17.5 to 19.5	0.689-0.768			
	03-Ø20/Ø21	3	0.118	19.5 to 21.5	0.768-0.846			
B2	01-Ø22/Ø23	1	0.039	21.5 to 23.5	0.846-0.925	EP-BPA-SZ4-BL-A	1SNG604010R0000	200
	02-Ø24/Ø25	2	0.079	23.5 to 25.5	0.925-1.041			
	03-Ø26/Ø27	3	0.118	25.5 to 27.5	1.041-1.083			
	04-Ø28/Ø29	4	0.157	27.5 to 29.5	1.083-1.161			

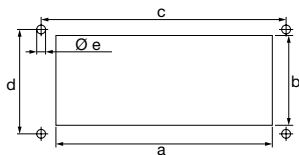

### Cut-out dimensions

a	b	c	d	e
mm	mm	mm	mm	mm
112	46	130	32	5

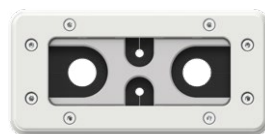

4 Ways

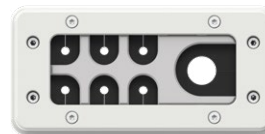

7 Ways

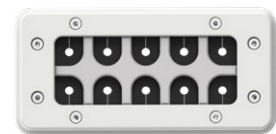

10 Ways

All the main technical data provided are "manufacturer" values  
Refers to UL files for precise approval per products

RoHS	USR CNR								
------	---------	--	--	--	--	--	--	--	--

# Cable Entry Plates

## Standard Cable Entry Plates



### BRM cable plates

- For standard industrial applications , to be used instead of standard cable glands, when the space on the enclosure is limited and also as an economical solution
- The cable entry plates are designed for non-connectorised cables.
- Material:
  - Frames: PA Glass Fibre reinforced
  - Ingress protection membrane: BUTYL rubber
  - Spacer: Chloroprene
  - Obstruction membrane: Silicone or Polyurethane
  - Frame Seal: Polyurethane
- Ingress Protection Rating: IP65 / Type 12,13 / Type 4X (for Dia above 0.5 mm up to max)
- Flammability: HB According to UL94
- Operating temperature: -40 °C to +80 °C

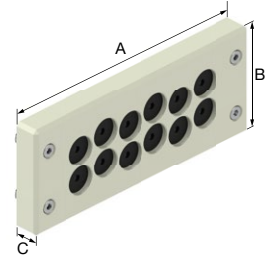

### Plates

No. of Cable Entries	Clamping Range		Frame			Depth		Light grey RAL 7035		Black RAL 9005		Pkg per Box	
	mm	in	Width A	Height B	mm	in	mm	in	Description	Part Number	Description		Part Number
0 (Blind)	-	-	148	5.827	60	2.362	13.5	0.531	EP-BRM-SZ0-LGR-A	1SNG603001R0000	EP-BRM-SZ0-BL-A	1SNG603002R0000	1
12	5 - 13	0.197-0.118	148	5.827	60	2.362	13.5	0.531	EP-BRM-SZ12-LGR-A	1SNG603003R0000	EP-BRM-SZ12-BL-A	1SNG603004R0000	1
14	5 - 11	0.197-0.039	148	5.827	60	2.362	13.5	0.531	EP-BRM-SZ14-LGR-A	1SNG603005R0000	EP-BRM-SZ14-BL-A	1SNG603006R0000	1
22 (16+4+2)	16 x 3 - 6.5 4 x 5 - 9.2 2 x 8 - 12.5	0.629x0.118 - 0.255 0.157x0.196 - 0.362 0.078x0.314 - 0.492	148	5.827	60	2.362	13.5	0.531	EP-BRM-SZ22-LGR-A	1SNG603007R0000	EP-BRM-SZ22-BL-A	1SNG603008R0000	1
23	4 - 8.5	0.157-0.335	148	5.827	60	2.362	13.5	0.531	EP-BRM-SZ23-LGR-A	1SNG603009R0000	EP-BRM-SZ23-BL-A	1SNG603010R0000	1
29	4 - 7	0.157-0.276	148	5.827	60	2.362	13.5	0.531	EP-BRM-SZ29-LGR-A	1SNG603011R0000	EP-BRM-SZ29-BL-A	1SNG603012R0000	1

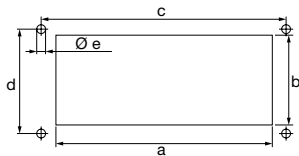

### Cut-out dimensions

a	b	c	d	e
mm	mm	mm	mm	mm
112	36	130	32	5



Blind

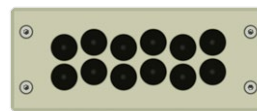

12 cable entries

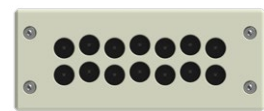

14 cable entries

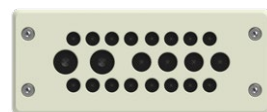

22 cable entries

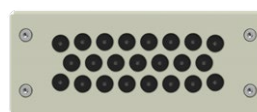

23 cable entries

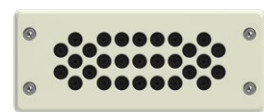

29 cable entries

All the main technical data provided are "manufacturer" values  
Refers to UL files for precise approval per products

RoHS	RoHS	USRCNR										
------	------	--------	--	--	--	--	--	--	--	--	--	--

# Ventilation Plugs

## Polyamide Ventilation Plugs



### Polyamide ventilation plugs

- Balances pressure differences between inner housing and the outside environment
- Prevents damages according to pressure differences.
- Prevents the formation of water condensation in tightly-sealed standard housings
- Membrane properties: hydrophobic, oleophobic.
- Material:
  - Body: PA 6
  - Ventilation Membran: Acrylic co-polymer on nylon-support
  - O-Ring: NBR (A,D & E types)
  - Gaskets: NBR (B,J & F types)
- Ingress Protection Rating: IP 68 / IP 67 (for water intrusion pressure 0.1 bar) IP 69K (only for D type)
- Flammability: V2 Acc. To UL94
- Operating temperature:
  - Permanent: -20 °C to +100 °C
  - Intermittent: -30 °C to +150 °C
- Accessories (refers to dedicated page): Locknuts

### Thread Type METRIC acc. to EN 60423

Outer Thread Size (Male)	Average Air Flow for $\Delta P = 70$ mbar/1psi	Water Intrusion Pressure	Outer Thread Length		Spanner Width		Outer $\varnothing$		Height		Design Type	Light grey RAL 7035 <input type="checkbox"/>	Description	Part Number
			TL mm	in	SW mm	in	D mm	in	H mm	in				
M6x0.75	8	0.5	10	0.394	10	0.394	11	0.433	6.15	0.242	D		EP-VEP-M6-LGR-A	1SNG605001R0000
M8x1.0	15	0.5	10	0.394	12	0.472	13	0.512	6.15	0.242	D		EP-VEP-M8-LGR-A	1SNG605004R0000
M12x1.0	16	0.9	6.6	0.260	17	0.669	18.5	0.728	7.6	0.299	A		EP-VEP-M1210-LGR-A	1SNG605007R0000
	25	0.5	6.6	0.260	17	0.669	18.5	0.728	7.6	0.299	A		EP-VEP-M1210-LGR-B	1SNG605010R0000
	120	0.2	6.6	0.260	17	0.669	18.5	0.728	7.6	0.299	A		EP-VEP-M1210-LGR-C	1SNG605013R0000
	300	0.1	6.6	0.260	17	0.669	18.5	0.728	7.6	0.299	A		EP-VEP-M1210-LGR-D	1SNG605016R0000
M12x1.5	25	0.5	10	0.394	17	0.669	18.8	0.740	6.15	0.242	D		EP-VEP-M12-LGR-A	1SNG605019R0000
	16	0.9	6	0.236	17	0.669	18.5	0.728	7.6	0.299	A		EP-VEP-M12-LGR-B	1SNG605022R0000
	16	0.9	10	0.394	17	0.669	18.5	0.728	7.6	0.299	A		EP-VEP-M12-LGR-C	1SNG605025R0000
	25	0.5	6	0.236	17	0.669	18.5	0.728	7.6	0.299	A		EP-VEP-M12-LGR-D	1SNG605028R0000
	25	0.5	10	0.394	17	0.669	18.5	0.728	7.6	0.299	A		EP-VEP-M12-LGR-E	1SNG605031R0000
	42	0.9	10	0.394	24	0.945	26	1.024	11.7	0.461	E		EP-VEP-M12-LGR-F	1SNG605034R0000
	120	0.5	10	0.394	24	0.945	26	1.024	11.7	0.461	E		EP-VEP-M12-LGR-G	1SNG605037R0000
	120	0.2	6	0.236	17	0.669	18.5	0.728	7.6	0.299	A		EP-VEP-M12-LGR-H	1SNG605040R0000
	120	0.2	10	0.394	17	0.669	18.5	0.728	7.6	0.299	A		EP-VEP-M12-LGR-I	1SNG605043R0000
	300	0.1	6	0.236	17	0.669	18.5	0.728	7.6	0.299	A		EP-VEP-M12-LGR-J	1SNG605046R0000
	300	0.1	10	0.394	17	0.669	18.5	0.728	7.6	0.299	A		EP-VEP-M12-LGR-K	1SNG605049R0000
	450	0.2	10	0.394	24	0.945	26	1.024	11.7	0.461	E		EP-VEP-M12-LGR-L	1SNG605052R0000
	750	0.1	10	0.394	24	0.945	26	1.024	11.7	0.461	E		EP-VEP-M12-LGR-M	1SNG605055R0000
M16x1.5	42	0.9	10	0.394	24	0.945	26	1.024	11.7	0.461	E		EP-VEP-M16-LGR-A	1SNG605058R0000
	120	0.5	10	0.394	24	0.945	26	1.024	11.7	0.461	E		EP-VEP-M16-LGR-B	1SNG605061R0000
	450	0.2	10	0.394	24	0.945	26	1.024	11.7	0.461	E		EP-VEP-M16-LGR-C	1SNG605064R0000
	750	0.1	10	0.394	24	0.945	26	1.024	11.7	0.461	E		EP-VEP-M16-LGR-D	1SNG605067R0000
M20x1.5	42	0.9	10	0.394	24	0.945	26	1.024	11.7	0.461	E		EP-VEP-M20-LGR-A	1SNG605070R0000
	120	0.5	10	0.394	24	0.945	26	1.024	11.7	0.461	E		EP-VEP-M20-LGR-B	1SNG605073R0000
	450	0.2	10	0.394	24	0.945	26	1.024	11.7	0.461	E		EP-VEP-M20-LGR-C	1SNG605076R0000
	750	0.1	10	0.394	24	0.945	26	1.024	11.7	0.461	E		EP-VEP-M20-LGR-D	1SNG605079R0000
M40x1.5	120	0.9	18	0.709	-	-	55.3	2.177	15.5	0.610	F		EP-VEP-M40-LGR-A	1SNG605082R0000
	375	0.5	18	0.709	-	-	55.3	2.177	15.5	0.610	F		EP-VEP-M40-LGR-B	1SNG605085R0000
	1350	0.2	18	0.709	-	-	55.3	2.177	15.5	0.610	F		EP-VEP-M40-LGR-C	1SNG605088R0000
	2200	0.1	18	0.709	-	-	55.3	2.177	15.5	0.610	F		EP-VEP-M40-LGR-D	1SNG605091R0000

### Wall thickness (E) : 3,2 mm

Snap Size	Average Air Flow for $\Delta P = 70$ mbar/1psi	Water Intrusion Pressure	Snap Length		$\varnothing$	Spanner Width		Outer $\varnothing$		Height		Design Type	Light grey RAL 7035 <input type="checkbox"/>	Description	Part Number
			SL mm	in		SD mm	in	SW mm	in	D mm	in				
Snapfit 5.5	16	0.9	7.5	0.295	5.4	0.213	-	-	18.5	0.728	9.3	0.366	B	EP-VEP-SFAF16-LGR-A	1SNG605094R0000
	25	0.5	7.5	0.295	5.4	0.213	-	-	18.5	0.728	9.3	0.366	B	EP-VEP-SFAF25-LGR-A	1SNG605097R0000
	120	0.2	7.5	0.295	5.4	0.213	-	-	18.5	0.728	9.3	0.366	B	EP-VEP-SFAF120-LGR-A	1SNG605103R0000
	300	0.1	7.5	0.295	5.4	0.213	-	-	18.5	0.728	9.3	0.366	B	EP-VEP-SFAF300-LGR-A	1SNG605103R0000
	15	0.5	7.5	0.295	5.4	0.213	12	0.472	18.5	0.728	6.15	0.242	J	EP-VEP-SFAF15-LGR-A	1SNG605106R0000
	25	0.5	7.5	0.295	5.4	0.213	17	0.669	18.5	0.728	6.15	0.242	J	EP-VEP-SFAF25-LGR-B	1SNG605109R0000



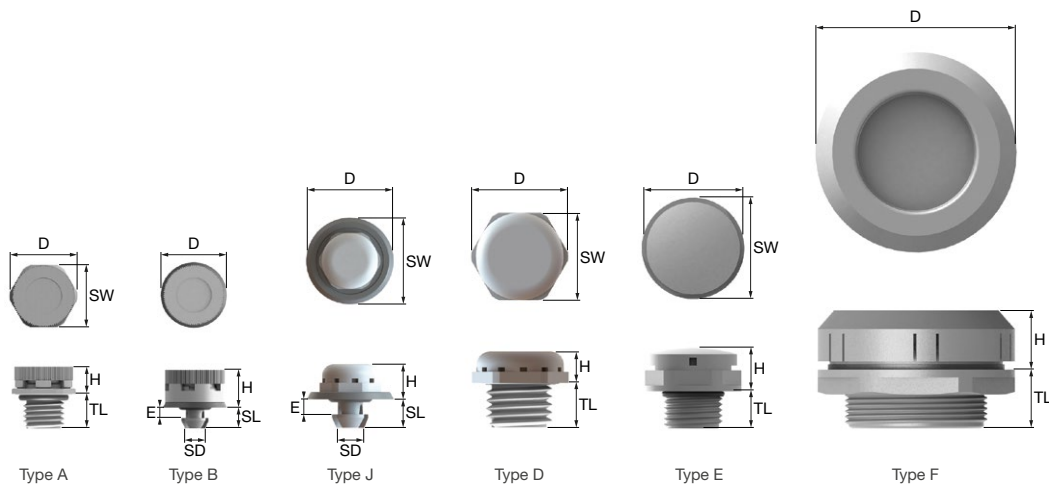

Grey RAL 7001 ■		Black RAL 9005 ■		Pkg
Description	Part Number	Description	Part Number	per Box
EP-VEP-M6-GR-A	1SNG605002R0000	EP-VEP-M6-BL-A	1SNG605003R0000	100
EP-VEP-M8-GR-A	1SNG605005R0000	EP-VEP-M8-BL-A	1SNG605006R0000	100
EP-VEP-M1210-GR-A	1SNG605008R0000	EP-VEP-M1210-BL-A	1SNG605009R0000	100
EP-VEP-M1210-GR-B	1SNG605011R0000	EP-VEP-M1210-BL-B	1SNG605012R0000	100
EP-VEP-M1210-GR-C	1SNG605014R0000	EP-VEP-M1210-BL-C	1SNG605015R0000	100
EP-VEP-M1210-GR-D	1SNG605017R0000	EP-VEP-M1210-BL-D	1SNG605018R0000	100
EP-VEP-M12-GR-A	1SNG605020R0000	EP-VEP-M12-BL-A	1SNG605021R0000	100
EP-VEP-M12-GR-B	1SNG605023R0000	EP-VEP-M12-BL-B	1SNG605024R0000	100
EP-VEP-M12-GR-C	1SNG605026R0000	EP-VEP-M12-BL-C	1SNG605027R0000	100
EP-VEP-M12-GR-D	1SNG605029R0000	EP-VEP-M12-BL-D	1SNG605030R0000	100
EP-VEP-M12-GR-E	1SNG605032R0000	EP-VEP-M12-BL-E	1SNG605033R0000	100
EP-VEP-M12-GR-F	1SNG605035R0000	EP-VEP-M12-BL-F	1SNG605036R0000	100
EP-VEP-M12-GR-G	1SNG605038R0000	EP-VEP-M12-BL-G	1SNG605039R0000	100
EP-VEP-M12-GR-H	1SNG605041R0000	EP-VEP-M12-BL-H	1SNG605042R0000	100
EP-VEP-M12-GR-I	1SNG605044R0000	EP-VEP-M12-BL-I	1SNG605045R0000	100
EP-VEP-M12-GR-J	1SNG605047R0000	EP-VEP-M12-BL-J	1SNG605048R0000	100
EP-VEP-M12-GR-K	1SNG605050R0000	EP-VEP-M12-BL-K	1SNG605051R0000	100
EP-VEP-M12-GR-L	1SNG605053R0000	EP-VEP-M12-BL-L	1SNG605054R0000	100
EP-VEP-M12-GR-M	1SNG605056R0000	EP-VEP-M12-BL-M	1SNG605057R0000	100
EP-VEP-M16-GR-A	1SNG605059R0000	EP-VEP-M16-BL-A	1SNG605060R0000	100
EP-VEP-M16-GR-B	1SNG605062R0000	EP-VEP-M16-BL-B	1SNG605063R0000	100
EP-VEP-M16-GR-C	1SNG605065R0000	EP-VEP-M16-BL-C	1SNG605066R0000	100
EP-VEP-M16-GR-D	1SNG605068R0000	EP-VEP-M16-BL-D	1SNG605069R0000	100
EP-VEP-M20-GR-A	1SNG605071R0000	EP-VEP-M20-BL-A	1SNG605072R0000	100
EP-VEP-M20-GR-B	1SNG605074R0000	EP-VEP-M20-BL-B	1SNG605075R0000	100
EP-VEP-M20-GR-C	1SNG605077R0000	EP-VEP-M20-BL-C	1SNG605078R0000	100
EP-VEP-M20-GR-D	1SNG605080R0000	EP-VEP-M20-BL-D	1SNG605081R0000	100
EP-VEP-M40-GR-A	1SNG605083R0000	EP-VEP-M40-BL-A	1SNG605084R0000	50
EP-VEP-M40-GR-B	1SNG605086R0000	EP-VEP-M40-BL-B	1SNG605087R0000	50
EP-VEP-M40-GR-C	1SNG605089R0000	EP-VEP-M40-BL-C	1SNG605090R0000	50
EP-VEP-M40-GR-D	1SNG605092R0000	EP-VEP-M40-BL-D	1SNG605093R0000	50

Grey RAL 7001 ■		Black RAL 9005 ■		Pkg
Description	Part Number	Description	Part Number	per Box
EP-VEP-SFAF16-GR-A	1SNG605095R0000	EP-VEP-SFAF16-BL-A	1SNG605096R0000	500
EP-VEP-SFAF25-GR-A	1SNG605098R0000	EP-VEP-SFAF25-BL-A	1SNG605099R0000	500
EP-VEP-SFAF120-GR-A	1SNG605101R0000	EP-VEP-SFAF120-BL-A	1SNG605102R0000	500
EP-VEP-SFAF300-GR-A	1SNG605104R0000	EP-VEP-SFAF300-BL-A	1SNG605105R0000	500
EP-VEP-SFAF15-GR-A	1SNG605107R0000	EP-VEP-SFAF15-BL-A	1SNG605108R0000	500
EP-VEP-SFAF25-GR-B	1SNG605110R0000	EP-VEP-SFAF25-BL-B	1SNG605111R0000	500

All the main technical data provided are "manufacturer" values  
Refers to UL files for precise approval per products

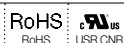

# Ventilation Plugs

## Metal Ventilation Plugs



### Metal ventilation plugs

- For industrial applications in harsh environments
- Balances pressure differences between inner housing and the outside environment
- Prevents damages according to pressure differences
- Prevents the formation of water condensation in tightly-sealed standard housings
- Membrane properties: hydrophobic, oleophobic
- Material:
  - Ventilation plug: Stainless steel, Aluminium
  - Ventilation Membran: Acrylic co-polymer on nylon-support
  - O-Ring: NBR
- Ingress Protection Rating: IP 68 / IP 67  
(for water intrusion pressure 0.1 bar)
- Operating temperature:
  - Permanent: -20 °C to +100 °C
  - Intermittent: -30 °C to +150 °C
- Accessories (refers to dedicated page): Locknuts, Washer Gaskets

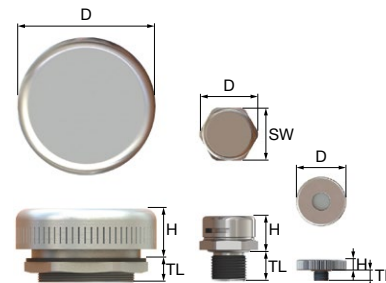

### Thread Type METRIC acc. to EN 60423 (Stainless Steel 303)

Size	Average Air Flow for ΔP = 70 mbar l/h	Water Intrusion Pressure bar	Outer Thread Length		Spanner Width SW		Outer Ø		Height		Design Type	Description	Part Number	Pkg per Box	
			TL mm	TL in	mm	in	D mm	D in	H mm	H in					
M12x1.0	16	0.9	10	0.394	17	0.669	18.8	0.740	11	0.433	C	EM-VEP-M1210-MET-A	1SNG624001R0000	50	
	25	0.5	10	0.394	17	0.669	18.8	0.740	11	0.433	C	EM-VEP-M1210-MET-B	1SNG624002R0000	50	
	120	0.2	10	0.394	17	0.669	18.8	0.740	11	0.433	C	EM-VEP-M1210-MET-C	1SNG624003R0000	50	
	300	0.1	10	0.394	17	0.669	18.8	0.740	11	0.433	C	EM-VEP-M1210-MET-D	1SNG624004R0000	50	
M12x1.5	16	0.9	6	0.236	17	0.669	18.8	0.740	11	0.433	C	EM-VEP-M12-MET-A	1SNG624005R0000	50	
	3	0.9	10	0.394	17	0.669	18.8	0.740	11	0.433	C	EM-VEP-M12-MET-B	1SNG624006R0000	50	
	25	0.5	6	0.236	17	0.669	18.8	0.740	11	0.433	C	EM-VEP-M12-MET-C	1SNG624007R0000	50	
	25	0.5	10	0.394	17	0.669	18.8	0.740	11	0.433	C	EM-VEP-M12-MET-D	1SNG624008R0000	50	
	120	0.2	6	0.236	17	0.669	18.8	0.740	11	0.433	C	EM-VEP-M12-MET-E	1SNG624009R0000	50	
	120	0.2	10	0.394	17	0.669	18.8	0.740	11	0.433	C	EM-VEP-M12-MET-F	1SNG624010R0000	50	
	300	0.1	6	0.236	17	0.669	18.8	0.740	11	0.433	C	EM-VEP-M12-MET-G	1SNG624011R0000	50	
	300	0.1	10	0.394	17	0.669	18.8	0.740	11	0.433	C	EM-VEP-M12-MET-H	1SNG624012R0000	50	
M16x1.5	16	0.9	6	0.236	18	0.709	20	0.787	12	0.472	C	EM-VEP-M16-MET-A	1SNG624013R0000	50	
	16	0.9	6	0.236	18	0.709	20	0.787	16	0.630	C	EM-VEP-M16-MET-B	1SNG624014R0000	50	
	25	0.5	6	0.236	18	0.709	20	0.787	12	0.472	C	EM-VEP-M16-MET-C	1SNG624015R0000	50	
	25	0.5	6	0.236	18	0.709	20	0.787	16	0.630	C	EM-VEP-M16-MET-D	1SNG624016R0000	50	
	120	0.2	6	0.236	18	0.709	20	0.787	12	0.472	C	EM-VEP-M16-MET-E	1SNG624017R0000	50	
	120	0.2	6	0.236	18	0.709	20	0.787	16	0.630	C	EM-VEP-M16-MET-F	1SNG624018R0000	50	
	300	0.1	6	0.236	18	0.709	20	0.787	12	0.472	C	EM-VEP-M16-MET-G	1SNG624019R0000	50	
	300	0.1	6	0.236	18	0.709	20	0.787	16	0.630	C	EM-VEP-M16-MET-H	1SNG624020R0000	50	
	M20x1.5	16	0.9	6	0.236	22	0.866	24.5	0.965	13	0.512	C	EM-VEP-M20-MET-A	1SNG624021R0000	50
		16	0.9	6	0.236	22	0.866	24.5	0.965	17	0.669	C	EM-VEP-M20-MET-B	1SNG624022R0000	50
25		0.5	6	0.236	22	0.866	24.5	0.965	13	0.512	C	EM-VEP-M20-MET-C	1SNG624023R0000	50	
25		0.5	6	0.236	22	0.866	24.5	0.965	17	0.669	C	EM-VEP-M20-MET-D	1SNG624024R0000	50	
120		0.2	6	0.236	22	0.866	24.5	0.965	13	0.512	C	EM-VEP-M20-MET-E	1SNG624025R0000	50	
120		0.2	6	0.236	22	0.866	24.5	0.965	17	0.669	C	EM-VEP-M20-MET-F	1SNG624026R0000	50	
300		0.1	6	0.236	22	0.866	24.5	0.965	13	0.512	C	EM-VEP-M20-MET-G	1SNG624027R0000	50	
300		0.1	6	0.236	22	0.866	24.5	0.965	17	0.669	C	EM-VEP-M20-MET-H	1SNG624028R0000	50	
M40x1.5	120	0.9	10	0.394	-	-	58	2.283	20.5	0.807	D	EM-VEP-M40-MET-A	1SNG624029R0000	1	
	375	0.5	10	0.394	-	-	58	2.283	20.5	0.807	D	EM-VEP-M40-MET-B	1SNG624030R0000	1	
	1350	0.2	10	0.394	-	-	58	2.283	20.5	0.807	D	EM-VEP-M40-MET-C	1SNG624031R0000	1	
	2200	0.1	10	0.394	-	-	58	2.283	20.5	0.807	D	EM-VEP-M40-MET-D	1SNG624032R0000	1	

All the main technical data provided are "manufacturer" values  
Refers to UL files for precise approval per products

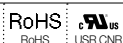

# Drain Plugs

## Polyamide, Drain Plugs



### Polyamide, drain plugs

- Drains condensed water in the housing
- Helps to avoid any potential damage to sensitive electric/electronic equipment in the housing due to condensed water
- Also allows air in the housing to breathe with the surrounding atmosphere
- Material: Body: PA66
- Ingress Protection Rating: IP 56 / IP 66 (Category 2)
- Flammability: V2 according to UL94
- Operating temperature:
  - Permanent: -20 °C to +100 °C
  - Intermittent: -30 °C to +150 °C
- Accessories (refers to dedicated page): Locknuts, Washer Gaskets

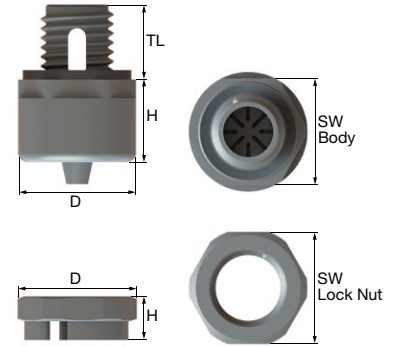

### Thread Type METRIC acc. to EN 60423

Outer Thread Size (Male)	Outer Thread Length		Outer Ø		Height		Light grey RAL 7035		Grey RAL 7001		Black RAL 9005		Pkg per Box
	TL		D		H		Description	Part Number	Description	Part Number	Description	Part Number	
	mm	in	mm	in	mm	in							
M12x1.5	12	0.5	19	0.7	17	0.7	EP-DRP-M12-LGR-A	1SNG611001R0000	EP-DRP-M12-GR-A	1SNG611002R0000	EP-DRP-M12-BL-A	1SNG611003R0000	100

  

Inner Thread Size (Female)	Spanner Width SW		Outer Ø		Height		Light grey RAL 7035		Grey RAL 7001		Black RAL 9005		Pkg per Box
	Locknut		D		H		Description	Part Number	Description	Part Number	Description	Part Number	
	mm	in	mm	in	mm	in							
M12x1.5	18	0.7	19.2	0.8	7	0.3	EP-DRP-M12-LGR-B	1SNG611004R0000	EP-DRP-M12-GR-B	1SNG611005R0000	EP-DRP-M12-BL-B	1SNG611006R0000	100

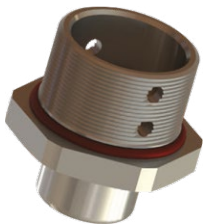

### Brass, Drain plugs

- Drains condensed water in the housing.
- Helps to avoid any potential damage to sensitive electric/electronic equipment in the housing
- Due to condensed water.
- Also allows air in the housing to breathe with the surrounding atmosphere.
- Material: Body: Brass, Brass Nickel Plated, Stainless Steel  
Bushing: Bronze / O-Ring: Silicone
- Ingress Protection Rating: IP 68 – 5 Bar, 30 min / IP66
- Operating temperature: - 60 °C to + 85 °C
- Accessories (refers to dedicated page): Locknuts, Washer Gaskets

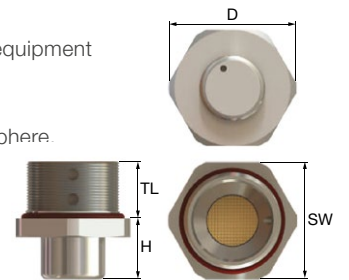

### Thread Type METRIC acc. to EN 60423

Outer Thread Size (Male)	Outer Thread Length		Spanner Width		Outer Ø		Height		Description	Part Number	Pkg per Box
	TL		SW		D		H				
	mm	in	mm	in	mm	in	mm	in			
M20x1.5	15	0.591	25	0.984	27.5	1.083	16	0.630	EM-DRP-M20-MET-A	1SNG612001R0000	63
M25x1.5	15	0.591	30	1.181	33	1.299	16	0.630	EM-DRP-M25-MET-A	1SNG612002R0000	35

### Thread Type NPT acc. to ANSI ASME B1.20.1

Outer Thread Size (Male)	Outer Thread Length		Spanner Width		Outer Ø		Height		Description	Part Number	Pkg per Box
	TL		SW		D		H				
	mm	in	mm	in	mm	in	mm	in			
NPT 1/2"	16	0.630	25	0.984	27.5	1.083	16	0.630	EM-DRP-NPT12-MET-A	1SNG612003R0000	63
NPT 3/4"	16	0.630	30	1.181	33	1.299	16	0.630	EM-DRP-NPT34-MET-A	1SNG612004R0000	35

### Locknuts For Drain Plugs Brass Nickel Plated Metric

Size	Description	Part Number	Pkg per Box
M20	EM-DRP-M20-MET-B	1SNG612005R0000	63
M25	EM-DRP-M25-MET-B	1SNG612006R0000	35

### Locknuts For Drain Plug Brass Nickel Plated NPSL

Size	Description	Part Number	Pkg per Box
NPSL 1/2"	EM-DRP-NPT12-MET-B	1SNG612007R0000	63
NPSL 3/4"	EM-DRP-NPT34-MET-B	1SNG612008R0000	35

All the main technical data provided are "manufacturer" values  
Refers to UL files for precise approval per products

RoHS	UL	USRCNR																	
------	----	--------	--	--	--	--	--	--	--	--	--	--	--	--	--	--	--	--	--

# Round Plugs

## Polyamide, Round Plugs



### Plugs, round, polyamide

- For standard industrial applications.
- Seal of housing hole when no cable gland is used
- Material: Body: PA6 / O-ring: NBR
- Ingress Protection Rating: IP 68 - 5 Bar, 30 min
- Flammability: V2 according to UL94
- Operating temperature:
  - Permanent: -20 °C to +100 °C
  - Intermittent: -30 °C to +150 °C
- Accessories (refers to dedicated page): Locknuts

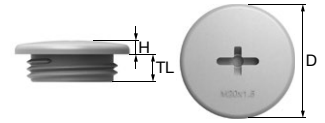

### Thread Type METRIC acc. to EN 60423

Outer Thread Size (Male)	Length		Outer Ø		Height		Light grey RAL 7035		Grey RAL 7001		Black RAL 9005		Pkg per Box
	TL		D		H		Description	Part Number	Description	Part Number	Description	Part Number	
M12x1.5	6	0.236	15	0.591	3	0.118	EP-ROP-M12-LGR-A	1SNG620001R0000	EP-ROP-M12-GR-A	1SNG620002R0000	EP-ROP-M12-BL-A	1SNG620003R0000	100
	10	0.394	15	0.591	3	0.118	EP-ROP-M12-LGR-B	1SNG620004R0000	EP-ROP-M12-GR-B	1SNG620005R0000	EP-ROP-M12-BL-B	1SNG620006R0000	100
M16x1.5	6	0.236	19.5	0.768	3.4	0.134	EP-ROP-M16-LGR-A	1SNG620007R0000	EP-ROP-M16-GR-A	1SNG620008R0000	EP-ROP-M16-BL-A	1SNG620009R0000	50
	10	0.394	19.5	0.768	3.4	0.134	EP-ROP-M16-LGR-B	1SNG620010R0000	EP-ROP-M16-GR-B	1SNG620011R0000	EP-ROP-M16-BL-B	1SNG620012R0000	50
M20x1.5	6	0.236	25	0.984	3	0.118	EP-ROP-M20-LGR-A	1SNG620013R0000	EP-ROP-M20-GR-A	1SNG620014R0000	EP-ROP-M20-BL-A	1SNG620015R0000	50
	10	0.394	25	0.984	3	0.118	EP-ROP-M20-LGR-B	1SNG620016R0000	EP-ROP-M20-GR-B	1SNG620017R0000	EP-ROP-M20-BL-B	1SNG620018R0000	50
M25x1.5	6	0.236	30	1.181	4	0.157	EP-ROP-M25-LGR-A	1SNG620019R0000	EP-ROP-M25-GR-A	1SNG620020R0000	EP-ROP-M25-BL-A	1SNG620021R0000	50
	10	0.394	30	1.181	4	0.157	EP-ROP-M25-LGR-B	1SNG620022R0000	EP-ROP-M25-GR-B	1SNG620023R0000	EP-ROP-M25-BL-B	1SNG620024R0000	50
	15	0.591	30	1.181	4	0.157	EP-ROP-M25-LGR-C	1SNG620025R0000	EP-ROP-M25-GR-C	1SNG620026R0000	EP-ROP-M25-BL-C	1SNG620027R0000	50
M32x1.5	8	0.315	37	1.457	4	0.157	EP-ROP-M32-LGR-A	1SNG620028R0000	EP-ROP-M32-GR-A	1SNG620029R0000	EP-ROP-M32-BL-A	1SNG620030R0000	25
	10	0.394	37	1.457	4	0.157	EP-ROP-M32-LGR-B	1SNG620031R0000	EP-ROP-M32-GR-B	1SNG620032R0000	EP-ROP-M32-BL-B	1SNG620033R0000	25
M40x1.5	8	0.315	46	1.811	4.5	0.177	EP-ROP-M40-LGR-A	1SNG620034R0000	EP-ROP-M40-GR-A	1SNG620035R0000	EP-ROP-M40-BL-A	1SNG620036R0000	10
	10	0.394	46	1.811	4.5	0.177	EP-ROP-M40-LGR-B	1SNG620037R0000	EP-ROP-M40-GR-B	1SNG620038R0000	EP-ROP-M40-BL-B	1SNG620039R0000	10
M50x1.5	10	0.394	54.9	2.161	3.7	0.146	EP-ROP-M50-LGR-A	1SNG620040R0000	EP-ROP-M50-GR-A	1SNG620041R0000	EP-ROP-M50-BL-A	1SNG620042R0000	10

### Thread Type PG acc. to DIN 40430

Outer Thread Size (Male)	Length		Outer Ø		Height		Light grey RAL 7035		Grey RAL 7001		Black RAL 9005		Pkg per Box
	TL		D		H		Description	Part Number	Description	Part Number	Description	Part Number	
PG 7	6	0.236	15	0.591	3	0.118	EP-ROP-PG7-LGR-A	1SNG620043R0000	EP-ROP-PG7-GR-A	1SNG620044R0000	EP-ROP-PG7-BL-A	1SNG620045R0000	100
	10	0.394	15	0.591	3	0.118	EP-ROP-PG7-LGR-B	1SNG620046R0000	EP-ROP-PG7-GR-B	1SNG620047R0000	EP-ROP-PG7-BL-B	1SNG620048R0000	100
PG 9	6	0.236	19.5	0.768	3	0.118	EP-ROP-PG9-LGR-A	1SNG620049R0000	EP-ROP-PG9-GR-A	1SNG620050R0000	EP-ROP-PG9-BL-A	1SNG620051R0000	50
	10	0.394	19.5	0.768	3	0.118	EP-ROP-PG9-LGR-B	1SNG620052R0000	EP-ROP-PG9-GR-B	1SNG620053R0000	EP-ROP-PG9-BL-B	1SNG620054R0000	50
PG 11	6	0.236	22	0.866	3	0.118	EP-ROP-PG11-LGR-A	1SNG620055R0000	EP-ROP-PG11-GR-A	1SNG620056R0000	EP-ROP-PG11-BL-A	1SNG620057R0000	50
	10	0.394	22	0.866	3	0.118	EP-ROP-PG11-LGR-B	1SNG620058R0000	EP-ROP-PG11-GR-B	1SNG620059R0000	EP-ROP-PG11-BL-B	1SNG620060R0000	50
PG 13.5	6	0.236	24.7	0.972	3	0.118	EP-ROP-PG135-LGR-A	1SNG620061R0000	EP-ROP-PG135-GR-A	1SNG620062R0000	EP-ROP-PG135-BL-A	1SNG620063R0000	50
	10	0.394	24.7	0.972	3	0.118	EP-ROP-PG135-LGR-B	1SNG620064R0000	EP-ROP-PG135-GR-B	1SNG620065R0000	EP-ROP-PG135-BL-B	1SNG620066R0000	50
PG 16	6	0.236	27	1.063	3.4	0.134	EP-ROP-PG16-LGR-A	1SNG620067R0000	EP-ROP-PG16-GR-A	1SNG620068R0000	EP-ROP-PG16-BL-A	1SNG620069R0000	50
	10	0.394	27	1.063	3.4	0.134	EP-ROP-PG16-LGR-B	1SNG620070R0000	EP-ROP-PG16-GR-B	1SNG620071R0000	EP-ROP-PG16-BL-B	1SNG620072R0000	50
PG 21	8	0.315	33	1.299	4	0.157	EP-ROP-PG21-LGR-A	1SNG620073R0000	EP-ROP-PG21-GR-A	1SNG620074R0000	EP-ROP-PG21-BL-A	1SNG620075R0000	50
	10	0.394	33	1.299	4	0.157	EP-ROP-PG21-LGR-B	1SNG620076R0000	EP-ROP-PG21-GR-B	1SNG620077R0000	EP-ROP-PG21-BL-B	1SNG620078R0000	50
PG 29	8	0.315	44	1.732	3.2	0.126	EP-ROP-PG29-LGR-A	1SNG620079R0000	EP-ROP-PG29-GR-A	1SNG620080R0000	EP-ROP-PG29-BL-A	1SNG620081R0000	25
	10	0.394	44	1.732	3.2	0.126	EP-ROP-PG29-LGR-B	1SNG620082R0000	EP-ROP-PG29-GR-B	1SNG620083R0000	EP-ROP-PG29-BL-B	1SNG620084R0000	25
PG 36	10	0.394	55	2.165	3.7	0.146	EP-ROP-PG36-LGR-A	1SNG620085R0000	EP-ROP-PG36-GR-A	1SNG620086R0000	EP-ROP-PG36-BL-A	1SNG620087R0000	10

All the main technical data provided are "manufacturer" values

RoHS  
RoHS



# Round Plugs

## Metal, Round Plugs



### Round plugs, metal

- For standard industrial applications in harsh environment
- Seal of housing hole when no cable gland is used
- Material: Body: Brass, Brass Nickel Plated, Stainless steel, Galvanised Steel / O-ring: NBR, Silicone
- Ingress Protection Rating: IP 68 (5 bar, 30 min), according to EN 60 529
- Operating temperature:
  - With O-Ring material in NBR: -30 °C to +100 °C
  - With O-Ring material in Silicone: -60 °C to +140 °C
- Accessories (refers to dedicated page): Locknuts, Washer Gaskets

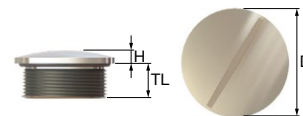

### Thread Type METRIC acc. to EN 60423

Outer Thread Size (Male)	Outer Thread Length		Outer Ø		Height		Description	Part Number	Pkg per Box
	TL mm	in	D mm	in	H mm	in			
M12x1.5	6	0.236	15	0.591	2.5	0.098	EM-ROP-M12-MET-A	1SNG621001R0000	63
M16x1.5	7	0.276	19	0.748	3	0.118	EM-ROP-M16-MET-A	1SNG621002R0000	63
M20x1.5	8	0.315	23	0.906	3	0.118	EM-ROP-M20-MET-A	1SNG621003R0000	63
M25x1.5	8	0.315	29	1.142	4	0.157	EM-ROP-M25-MET-A	1SNG621004R0000	35
M32x1.5	9	0.354	36	1.417	4	0.157	EM-ROP-M32-MET-A	1SNG621005R0000	35
M40x1.5	9	0.354	44	1.732	4	0.157	EM-ROP-M40-MET-A	1SNG621006R0000	20
M50x1.5	9	0.354	54	2.126	5	0.197	EM-ROP-M50-MET-A	1SNG621007R0000	12
M63x1.5	10	0.394	69	2.717	6	0.236	EM-ROP-M63-MET-A	1SNG621008R0000	12

### Thread Type PG acc. to DIN 40430

Outer Thread Size (Male)	Outer Thread Length		Outer Ø		Height		Description	Part Number	Pkg per Box
	TL mm	in	D mm	in	H mm	in			
PG 7	6	0.236	16	0.630	3	0.118	EM-ROP-PG7-MET-A	1SNG621009R0000	63
PG 9	6	0.236	19	0.748	3	0.118	EM-ROP-PG9-MET-A	1SNG621010R0000	63
PG 11	6	0.236	22	0.866	3	0.118	EM-ROP-PG11-MET-A	1SNG621011R0000	63
PG 13.5	7	0.256	24	0.945	3	0.118	EM-ROP-PG135-MET-A	1SNG621012R0000	63
PG 16	7	0.256	26	1.024	3	0.118	EM-ROP-PG16-MET-A	1SNG621013R0000	35
PG 21	7	0.276	33	1.299	4	0.157	EM-ROP-PG21-MET-A	1SNG621014R0000	35
PG 29	8	0.315	42	1.654	4	0.157	EM-ROP-PG29-MET-A	1SNG621015R0000	20
PG 36	9	0.354	52	2.047	6	0.236	EM-ROP-PG36-MET-A	1SNG621016R0000	12
PG 42	10	0.394	59	2.323	6	0.236	EM-ROP-PG42-MET-A	1SNG621017R0000	12
PG 48	10	0.394	66	2.598	6	0.236	EM-ROP-PG48-MET-A	1SNG621018R0000	12

All the main technical data provided are "manufacturer" values

RoHS  
RoHS

# Accessories

## Dome Plugs



### Dome plugs for industrial applications

- Allows sealing of cable glands when no cable is used
- For standard industrial applications
- Material: PA 6
- Flammability: V2 acc. To UL94
- Operating temperature:
  - Permanent: -20 °C to +100 °C
  - Intermittent: -30 °C to +150 °C

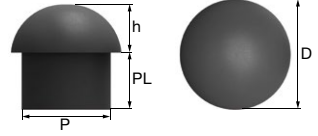

### Dome Plugs for Industrial Applications

Size	Plug		Outer Ø				Height		Dome Plug Fit Into Clamping Range Ø min-max								Light grey RAL 7035 <input type="checkbox"/>	
	Ø	Length	D		h		Standard Seal		Reducing Seal		Double Seal		Outer Seal		Description	Part Number		
			P	PL	mm	in	mm	in	mm	in	mm	in	mm	in			mm	in
9	4	0.157	12.0	0.472	9.2	0.362	4	0.157	-	-	-	-	-	-	-	-	EP-DOP-SZ9-LGR-A	1SNG610001R0000
	6.4	0.252	12.0	0.472	9.2	0.362	4	0.157	3 - 6.5	0.118-0.256	-	-	-	-	3 - 6.5	0.118-0.256	EP-DOP-SZ9-LGR-B	1SNG610004R0000
11	5	0.197	14.0	0.551	10.5	0.413	5	0.197	-	-	2 - 6	0.079-0.236	3.0 - 8.0	0.118-0.315	-	-	EP-DOP-SZ11-LGR-A	1SNG610007R0000
	8	0.315	13.7	0.539	10.5	0.413	4.7	0.185	4 - 8	0.157-0.315	-	-	-	-	4 - 8	0.157-0.315	EP-DOP-SZ11-LGR-B	1SNG610010R0000
13	7	0.276	15.0	0.591	13.3	0.524	5.7	0.224	-	-	3 - 7	0.118-0.276	3.0 - 10.0	0.118-0.394	-	-	EP-DOP-SZ13-LGR-A	1SNG610013R0000
	9.7	0.382	9.0	0.354	13.3	0.524	5.3	0.209	5 - 10	0.197-0.394	-	-	-	-	5 - 10	0.197-0.394	EP-DOP-SZ13-LGR-B	1SNG610016R0000
	9.7	0.382	15.0	0.591	13.3	0.524	5.7	0.224	5 - 10	0.197-0.394	-	-	-	-	5 - 10	0.197-0.394	EP-DOP-SZ13-LGR-C	1SNG610019R0000
16	7	0.276	14.0	0.551	15.8	0.622	7.5	0.295	-	-	-	-	3.0 - 13.0	0.118-0.512	-	-	EP-DOP-SZ16-LGR-A	1SNG610022R0000
	8.5	0.335	13.0	0.512	15.8	0.622	7.7	0.303	-	-	5 - 9	0.197-0.354	5.0 - 12.0	0.197-0.472	-	-	EP-DOP-SZ16-LGR-B	1SNG610025R0000
	12	0.472	13.0	0.512	15.8	0.622	8	0.315	6 - 12	0.236-0.472	-	-	-	-	6 - 12	0.236-0.472	EP-DOP-SZ16-LGR-C	1SNG610028R0000
	13	0.512	14.0	0.551	15.8	0.622	7.5	0.295	7 - 13	0.276-0.512	-	-	-	-	7 - 13	0.276-0.512	EP-DOP-SZ16-LGR-D	1SNG610031R0000
18	11	0.433	13.5	0.531	18	0.709	8.5	0.335	-	-	7 - 12	0.276-0.472	7.0 - 14.0	0.276-0.551	-	-	EP-DOP-SZ18-LGR-A	1SNG610034R0000
	13.6	0.535	13.5	0.531	18	0.709	8.7	0.343	10 - 14	0.394-0.551	-	-	-	-	10 - 14	0.394-0.551	EP-DOP-SZ18-LGR-B	1SNG610037R0000
20	13	0.512	14.5	0.571	20	0.787	7	0.276	-	-	9 - 13	0.354-0.512	8.0 - 17.0	0.315-0.669	-	-	EP-DOP-SZ20-LGR-A	1SNG610040R0000
	16.4	0.646	14.5	0.571	19.9	0.783	7.3	0.287	11 - 17	0.433-0.669	-	-	-	-	11 - 17	0.433-0.669	EP-DOP-SZ20-LGR-B	1SNG610043R0000
22	14	0.551	14.0	0.551	22	0.866	9.5	0.374	-	-	11 - 15	0.433-0.591	9.0 - 18.0	0.354-0.709	-	-	EP-DOP-SZ22-LGR-A	1SNG610046R0000
	17.8	0.701	14.0	0.551	22	0.866	10	0.394	13 - 18	0.512-0.709	-	-	-	-	13 - 18	0.512-0.709	EP-DOP-SZ22-LGR-B	1SNG610049R0000
24	16.1	0.634	15.5	0.610	24	0.945	9	0.354	-	-	9 - 16	0.354-0.63	11.0 - 21.0	0.433-0.827	-	-	EP-DOP-SZ24-LGR-A	1SNG610052R0000
	20.4	0.803	15.5	0.610	24.1	0.949	9.2	0.362	15 - 21	0.591-0.827	-	-	-	-	15 - 21	0.591-0.827	EP-DOP-SZ24-LGR-B	1SNG610055R0000
29	19.7	0.776	15.0	0.591	28.5	1.122	9.7	0.382	-	-	12 - 20	0.472-0.787	13.0 - 25.0	0.512-0.984	-	-	EP-DOP-SZ29-LGR-A	1SNG610058R0000
	25	0.984	15.0	0.591	28.5	1.122	9.7	0.382	18 - 25	0.709-0.984	-	-	-	-	18 - 25	0.709-0.984	EP-DOP-SZ29-LGR-B	1SNG610061R0000
32	20.5	0.807	15.8	0.622	31.5	1.240	9.2	0.362	-	-	16 - 23	0.63-0.906	16.0 - 28.0	0.63-1.102	-	-	EP-DOP-SZ32-LGR-A	1SNG610064R0000
	27.3	1.075	15.8	0.622	31.5	1.240	9.2	0.362	19 - 28	0.748-1.102	-	-	-	-	19 - 28	0.748-1.102	EP-DOP-SZ32-LGR-B	1SNG610067R0000
37	25.7	1.012	17.0	0.669	36.8	1.449	10.7	0.421	-	-	20 - 26	0.787-1.024	20.0 - 32.0	0.787-1.26	-	-	EP-DOP-SZ37-LGR-A	1SNG610070R0000
	31.8	1.252	17.0	0.669	36.8	1.449	10.7	0.421	22 - 32	0.866-1.26	-	-	-	-	19 - 28	0.748-1.102	EP-DOP-SZ37-LGR-B	1SNG610073R0000
45	30.6	1.205	20.2	0.795	43.3	1.705	11.9	0.469	-	-	25 - 31	0.984-1.22	21.0 - 38.0	0.827-1.496	-	-	EP-DOP-SZ45-LGR-A	1SNG610076R0000
	38	1.496	20.2	0.795	43.3	1.705	11.9	0.469	30 - 38	1.181-1.496	-	-	-	-	30 - 38	1.181-1.496	EP-DOP-SZ45-LGR-B	1SNG610079R0000
52	34.6	1.362	22.5	0.886	51	2.008	16	0.630	-	-	29 - 35	1.142-1.378	27.0 - 44.0	1.063-1.732	-	-	EP-DOP-SZ52-LGR-A	1SNG610082R0000
	44.2	1.740	22.5	0.886	51	2.008	16	0.630	34 - 44	1.339-1.732	-	-	-	-	34 - 44	1.339-1.732	EP-DOP-SZ52-LGR-B	1SNG610085R0000

Grey RAL 7001 ■		Black RAL 9005 ■		Pkg
Description	Part Number	Description	Part Number	per Box
EP-DOP-SZ9-GR-A	1SNG610002R0000	EP-DOP-SZ9-BL-A	1SNG610003R0000	100
EP-DOP-SZ9-GR-B	1SNG610005R0000	EP-DOP-SZ9-BL-B	1SNG610006R0000	100
EP-DOP-SZ11-GR-A	1SNG610008R0000	EP-DOP-SZ11-BL-A	1SNG610009R0000	100
EP-DOP-SZ11-GR-B	1SNG610011R0000	EP-DOP-SZ11-BL-B	1SNG610012R0000	100
EP-DOP-SZ13-GR-A	1SNG610014R0000	EP-DOP-SZ13-BL-A	1SNG610015R0000	100
EP-DOP-SZ13-GR-B	1SNG610017R0000	EP-DOP-SZ13-BL-B	1SNG610018R0000	100
EP-DOP-SZ13-GR-C	1SNG610020R0000	EP-DOP-SZ13-BL-C	1SNG610021R0000	100
EP-DOP-SZ16-GR-A	1SNG610023R0000	EP-DOP-SZ16-BL-A	1SNG610024R0000	100
EP-DOP-SZ16-GR-B	1SNG610026R0000	EP-DOP-SZ16-BL-B	1SNG610027R0000	100
EP-DOP-SZ16-GR-C	1SNG610029R0000	EP-DOP-SZ16-BL-C	1SNG610030R0000	100
EP-DOP-SZ16-GR-D	1SNG610032R0000	EP-DOP-SZ16-BL-D	1SNG610033R0000	100
EP-DOP-SZ18-GR-A	1SNG610035R0000	EP-DOP-SZ18-BL-A	1SNG610036R0000	50
EP-DOP-SZ18-GR-B	1SNG610038R0000	EP-DOP-SZ18-BL-B	1SNG610039R0000	50
EP-DOP-SZ20-GR-A	1SNG610041R0000	EP-DOP-SZ20-BL-A	1SNG610042R0000	50
EP-DOP-SZ20-GR-B	1SNG610044R0000	EP-DOP-SZ20-BL-B	1SNG610045R0000	50
EP-DOP-SZ22-GR-A	1SNG610047R0000	EP-DOP-SZ22-BL-A	1SNG610048R0000	50
EP-DOP-SZ22-GR-B	1SNG610050R0000	EP-DOP-SZ22-BL-B	1SNG610051R0000	50
EP-DOP-SZ24-GR-A	1SNG610053R0000	EP-DOP-SZ24-BL-A	1SNG610054R0000	10
EP-DOP-SZ24-GR-B	1SNG610056R0000	EP-DOP-SZ24-BL-B	1SNG610057R0000	10
EP-DOP-SZ29-GR-A	1SNG610059R0000	EP-DOP-SZ29-BL-A	1SNG610060R0000	10
EP-DOP-SZ29-GR-B	1SNG610062R0000	EP-DOP-SZ29-BL-B	1SNG610063R0000	10
EP-DOP-SZ32-GR-A	1SNG610065R0000	EP-DOP-SZ32-BL-A	1SNG610066R0000	10
EP-DOP-SZ32-GR-B	1SNG610068R0000	EP-DOP-SZ32-BL-B	1SNG610069R0000	10
EP-DOP-SZ37-GR-A	1SNG610071R0000	EP-DOP-SZ37-BL-A	1SNG610072R0000	10
EP-DOP-SZ37-GR-B	1SNG610074R0000	EP-DOP-SZ37-BL-B	1SNG610075R0000	10
EP-DOP-SZ45-GR-A	1SNG610077R0000	EP-DOP-SZ45-BL-A	1SNG610078R0000	10
EP-DOP-SZ45-GR-B	1SNG610080R0000	EP-DOP-SZ45-BL-B	1SNG610081R0000	10
EP-DOP-SZ52-GR-A	1SNG610083R0000	EP-DOP-SZ52-BL-A	1SNG610084R0000	10
EP-DOP-SZ52-GR-B	1SNG610086R0000	EP-DOP-SZ52-BL-B	1SNG610087R0000	10

All the main technical data provided are "manufacturer" values

RoHS  
RoHS

# Accessories

## Locknuts Flanged, Polyamide



### Locknuts flanged, polyamide

- Allows Safe fastening of cable glands.
- For standard industrial applications
- Flanged design offers safe sealing.
- Material: PA 6 GF 30
- Flammability: HB acc. To UL94
- Operating temperature:
  - Permanent: -20 °C to +100 °C
  - Intermittent: -30 °C to +150 °C

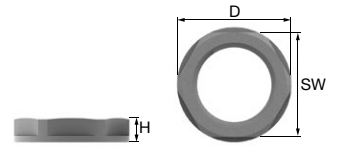

### Thread Type METRIC acc. to EN 60423

Inner Thread Size (Female)	Spanner Width SW		Outer Ø		Max. Height		Light grey RAL 7035		Grey RAL 7001		Black RAL 9005		Pkg per Box
	mm	in	mm	in	mm	in	Description	Part Number	Description	Part Number	Description	Part Number	
M12x1.5	18	0.709	19.5	0.768	5	0.197	EP-LN-M12-LGR-A	1SNG607001R0000	EP-LN-M12-GR-A	1SNG607002R0000	EP-LN-M12-BL-A	1SNG607003R0000	100
M16x1.5	22	0.866	24.2	0.953	5	0.197	EP-LN-M16-LGR-A	1SNG607004R0000	EP-LN-M16-GR-A	1SNG607005R0000	EP-LN-M16-BL-A	1SNG607006R0000	50
M20x1.5	26	1.024	28.6	1.126	6	0.236	EP-LN-M20-LGR-A	1SNG607007R0000	EP-LN-M20-GR-A	1SNG607008R0000	EP-LN-M20-BL-A	1SNG607009R0000	50
M25x1.5	32	1.260	35	1.378	6	0.236	EP-LN-M25-LGR-A	1SNG607010R0000	EP-LN-M25-GR-A	1SNG607011R0000	EP-LN-M25-BL-A	1SNG607012R0000	50
M32x1.5	41	1.614	46.1	1.815	7	0.276	EP-LN-M32-LGR-A	1SNG607013R0000	EP-LN-M32-GR-A	1SNG607014R0000	EP-LN-M32-BL-A	1SNG607015R0000	25
M40x1.5	50	1.969	55.3	2.177	7	0.276	EP-LN-M40-LGR-A	1SNG607016R0000	EP-LN-M40-GR-A	1SNG607017R0000	EP-LN-M40-BL-A	1SNG607018R0000	10
M50x1.5	60	2.362	65.7	2.587	8	0.315	EP-LN-M50-LGR-A	1SNG607019R0000	EP-LN-M50-GR-A	1SNG607020R0000	EP-LN-M50-BL-A	1SNG607021R0000	10
M63x1.5	75	2.953	82.5	3.248	8	0.315	EP-LN-M63-LGR-A	1SNG607022R0000	EP-LN-M63-GR-A	1SNG607023R0000	EP-LN-M63-BL-A	1SNG607024R0000	10
M75x2.0	85	3.346	94	3.701	15	0.591	EP-LN-M75-LGR-A	1SNG607025R0000	EP-LN-M75-GR-A	1SNG607026R0000	EP-LN-M75-BL-A	1SNG607027R0000	5

### Thread Type NPT acc. to ANSI B1.20.1

Inner Thread Size (Female)	Spanner Width SW		Outer Ø		Max. Height		Light grey RAL 7035		Grey RAL 7001		Black RAL 9005		Pkg per Box
	mm	in	mm	in	mm	in	Description	Part Number	Description	Part Number	Description	Part Number	
NPT 3/8"	22	0.866	25	0.984	7	0.276	EP-LN-NPT38-LGR-A	1SNG607028R0000	EP-LN-NPT38-GR-A	1SNG607029R0000	EP-LN-NPT38-BL-A	1SNG607030R0000	50
NPT 1/2"	27	1.063	30.5	1.201	7	0.276	EP-LN-NPT12-LGR-A	1SNG607031R0000	EP-LN-NPT12-GR-A	1SNG607032R0000	EP-LN-NPT12-BL-A	1SNG607033R0000	50
NPT 3/4"	33	1.299	37.5	1.476	7	0.276	EP-LN-NPT34-LGR-A	1SNG607034R0000	EP-LN-NPT34-GR-A	1SNG607035R0000	EP-LN-NPT34-BL-A	1SNG607036R0000	25
NPT 1"	41	1.614	46.2	1.819	7	0.276	EP-LN-NPT1-LGR-A	1SNG607037R0000	EP-LN-NPT1-GR-A	1SNG607038R0000	EP-LN-NPT1-BL-A	1SNG607039R0000	20

### Thread Type PG acc. to DIN 40430

Inner Thread Size (Female)	Spanner Width SW		Outer Ø		Max. Height		Light grey RAL 7035		Grey RAL 7001		Black RAL 9005		Pkg per Box
	mm	in	mm	in	mm	in	Description	Part Number	Description	Part Number	Description	Part Number	
PG 7	19	0.748	20.9	0.823	5	0.197	EP-LN-PG7-LGR-A	1SNG607040R0000	EP-LN-PG7-GR-A	1SNG607041R0000	EP-LN-PG7-BL-A	1SNG607042R0000	50
PG 9	22	0.866	23.9	0.941	5	0.197	EP-LN-PG9-LGR-A	1SNG607043R0000	EP-LN-PG9-GR-A	1SNG607044R0000	EP-LN-PG9-BL-A	1SNG607045R0000	50
PG 11	24	0.945	25.9	1.020	5	0.197	EP-LN-PG11-LGR-A	1SNG607046R0000	EP-LN-PG11-GR-A	1SNG607047R0000	EP-LN-PG11-BL-A	1SNG607048R0000	50
PG 13.5	27	1.063	28.9	1.138	6	0.236	EP-LN-PG135-LGR-A	1SNG607049R0000	EP-LN-PG135-GR-A	1SNG607050R0000	EP-LN-PG135-BL-A	1SNG607051R0000	50
PG 16	30	1.181	32.9	1.295	6	0.236	EP-LN-PG16-LGR-A	1SNG607052R0000	EP-LN-PG16-GR-A	1SNG607053R0000	EP-LN-PG16-BL-A	1SNG607054R0000	50
PG 21	36	1.417	38.8	1.528	7	0.276	EP-LN-PG21-LGR-A	1SNG607055R0000	EP-LN-PG21-GR-A	1SNG607056R0000	EP-LN-PG21-BL-A	1SNG607057R0000	25
PG 29	46	1.811	49.8	1.961	7	0.276	EP-LN-PG29-LGR-A	1SNG607058R0000	EP-LN-PG29-GR-A	1SNG607059R0000	EP-LN-PG29-BL-A	1SNG607060R0000	20
PG 36	60	2.362	65.7	2.587	8	0.315	EP-LN-PG36-LGR-A	1SNG607061R0000	EP-LN-PG36-GR-A	1SNG607062R0000	EP-LN-PG36-BL-A	1SNG607063R0000	10
PG 42	65	2.559	72.7	2.862	8	0.315	EP-LN-PG42-LGR-A	1SNG607064R0000	EP-LN-PG42-GR-A	1SNG607065R0000	EP-LN-PG42-BL-A	1SNG607066R0000	10
PG 48	70	2.756	77.7	3.059	8	0.315	EP-LN-PG48-LGR-A	1SNG607067R0000	EP-LN-PG48-GR-A	1SNG607068R0000	EP-LN-PG48-BL-A	1SNG607069R0000	10

All the main technical data provided are "manufacturer" values

RoHS  
RoHS



# Accessories

## Locknuts, Metal



### Locknuts, metal

- Allows Safe fastening of cable glands
- For standard industrial applications in harsh environments
- Material: Brass Nickel plated, Stainless Steel

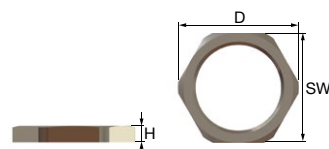

### Thread Type METRIC acc. to EN 60423

Inner Thread Size (Female)	Spanner Width SW		Outer Ø		Max. Height		Description	Part Number	Pkg per Box
	mm	in	D mm	in	H mm	in			
M12x1.5	15	0.591	16.6	0.654	2.8	0.110	EM-LN-M12-MET-A	1SNG608001R0000	100
M16x1.5	19	0.748	21	0.827	3	0.118	EM-LN-M16-MET-A	1SNG608002R0000	100
M20x1.5	24	0.945	26.5	1.043	3.5	0.138	EM-LN-M20-MET-A	1SNG608003R0000	100
M25x1.5	30	1.181	33	1.299	4	0.157	EM-LN-M25-MET-A	1SNG608004R0000	100
M32x1.5	36	1.417	39.5	1.555	5	0.197	EM-LN-M32-MET-A	1SNG608005R0000	50
M40x1.5	46	1.811	51	2.008	5	0.197	EM-LN-M40-MET-A	1SNG608006R0000	25
M50x1.5	60	2.362	66	2.598	5	0.197	EM-LN-M50-MET-A	1SNG608007R0000	10
M63x1.5	70	2.756	77	3.031	6	0.236	EM-LN-M63-MET-A	1SNG608008R0000	10

### Thread Type NPT acc. to ANSI B1.20.1

Inner Thread Size (Female)	Spanner Width SW		Outer Ø		Max. Height		Description	Part Number	Pkg per Box
	mm	in	D mm	in	H mm	in			
NPT 1/4"	17	0.669	18.8	0.740	5	0.197	EM-LN-NPT14-MET-A	1SNG608009R0000	100
NPT 3/8"	24	0.945	26.5	1.043	5	0.197	EM-LN-NPT38-MET-A	1SNG608010R0000	100
NPT 1/2"	24	0.945	26.5	1.043	5	0.197	EM-LN-NPT12-MET-A	1SNG608011R0000	100
NPT 3/4"	34	1.339	37.5	1.476	6	0.236	EM-LN-NPT34-MET-A	1SNG608012R0000	100
NPT 1"	42	1.654	46.4	1.827	6	0.236	EM-LN-NPT1-MET-A	1SNG608013R0000	50
NPT 1 1/4"	52	2.047	57.4	2.260	7	0.276	EM-LN-NPT114-MET-A	1SNG608014R0000	50
NPT 1 1/2"	60	2.362	65.1	2.563	7	0.276	EM-LN-NPT112-MET-A	1SNG608015R0000	25
NPT 2"	74	2.913	81.8	3.220	8	0.315	EM-LN-NPT2-MET-A	1SNG608016R0000	10

### Thread Type PG acc. to DIN 40430

Inner Thread Size (Female)	Spanner Width SW		Outer Ø		Max. Height		Description	Part Number	Pkg per Box
	mm	in	D mm	in	H mm	in			
PG 7	15	0.591	16.6	0.654	2.8	0.110	EM-LN-PG7-MET-A	1SNG608017R0000	100
PG 9	18	0.709	20	0.787	2.8	0.110	EM-LN-PG9-MET-A	1SNG608018R0000	100
PG 11	21	0.827	23.5	0.925	3	0.118	EM-LN-PG11-MET-A	1SNG608019R0000	100
PG 13.5	23	0.906	23.5	0.925	3	0.118	EM-LN-PG135-MET-A	1SNG608020R0000	100
PG 16	26	1.024	29	1.142	3	0.118	EM-LN-PG16-MET-A	1SNG608021R0000	100
PG 21	32	1.260	35.5	1.398	3.5	0.138	EM-LN-PG21-MET-A	1SNG608022R0000	100
PG 29	41	1.614	45	1.772	4	0.157	EM-LN-PG29-MET-A	1SNG608023R0000	100
PG 36	51	2.008	56	2.205	5	0.197	EM-LN-PG36-MET-A	1SNG608024R0000	25
PG 42	60	2.362	66	2.598	5	0.197	EM-LN-PG42-MET-A	1SNG608025R0000	10
PG 48	64	2.520	70.5	2.776	5.5	0.217	EM-LN-PG48-MET-A	1SNG608026R0000	10

All the main technical data provided are "manufacturer" values

RoHS  
RoHS

# Accessories

## Washer Gaskets



### Washer gaskets

- Ensures IP rating for rough surfaces or through holes.
- Material: CR & NBR

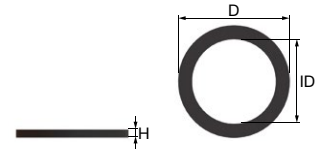

### Washer Gaskets for Metric Size

For Thread Size Metric	Outer Ø		Inner Ø		Height		CR Black ■		NBR Black ■		Pkg per Box
	D mm	in	ID mm	in	H mm	in	Description	Part Number	Description	Part Number	
M12	15.5	0.610	10.3	0.406	1.5	0.059	ECR-WG-M12-BL-A	1SNG609001R0000	ENBR-WG-M12-BL-A	1SNG609010R0000	500
M16	21.5	0.846	14.3	0.563	1.5	0.059	ECR-WG-M16-BL-A	1SNG609002R0000	ENBR-WG-M16-BL-A	1SNG609011R0000	500
M20	26	1.024	18.5	0.728	1.5	0.059	ECR-WG-M20-BL-A	1SNG609003R0000	ENBR-WG-M20-BL-A	1SNG609012R0000	500
M25	31.5	1.240	23.3	0.917	1.5	0.059	ECR-WG-M25-BL-A	1SNG609004R0000	ENBR-WG-M25-BL-A	1SNG609013R0000	500
M32	38.5	1.516	30.5	1.201	1.5	0.059	ECR-WG-M32-BL-A	1SNG609005R0000	ENBR-WG-M32-BL-A	1SNG609014R0000	500
M40	48.5	1.909	38.5	1.516	1.5	0.059	ECR-WG-M40-BL-A	1SNG609006R0000	ENBR-WG-M40-BL-A	1SNG609015R0000	500
M50	58	2.283	48	1.890	1.5	0.059	ECR-WG-M50-BL-A	1SNG609007R0000	ENBR-WG-M50-BL-A	1SNG609016R0000	300
M63	70	2.756	61.2	2.409	1.5	0.059	ECR-WG-M63-BL-A	1SNG609008R0000	ENBR-WG-M63-BL-A	1SNG609017R0000	300
M75	88	3.465	72.5	2.854	1.5	0.059	ECR-WG-M75-BL-A	1SNG609009R0000	ENBR-WG-M75-BL-A	1SNG609018R0000	200

### Washer Gaskets for NPT and G Size

For Thread Size NPT	Outer Ø		Inner Ø		Height		CR Black ■		NBR Black ■		Pkg per Box
	D mm	in	ID mm	in	H mm	in	Description	Part Number	Description	Part Number	
NPT 1/4"	16.8	0.661	11.7	0.461	2	0.079	ECR-WG-NPT14-BL-A	1SNG609019R0000	ENBR-WG-NPT14-BL-A	1SNG609027R0000	500
NPT 3/8"	24	0.945	16.4	0.646	2	0.079	ECR-WG-NPT38-BL-A	1SNG609020R0000	ENBR-WG-NPT38-BL-A	1SNG609028R0000	500
NPT 1/2"	29	1.142	20.4	0.803	2	0.079	ECR-WG-NPT12-BL-A	1SNG609021R0000	ENBR-WG-NPT12-BL-A	1SNG609029R0000	250
NPT 3/4"	37	1.457	26	1.024	2	0.079	ECR-WG-NPT34-BL-A	1SNG609022R0000	ENBR-WG-NPT34-BL-A	1SNG609030R0000	250
NPT 1"	45	1.772	32.6	1.283	2	0.079	ECR-WG-NPT1-BL-A	1SNG609023R0000	ENBR-WG-NPT1-BL-A	1SNG609031R0000	250
NPT 1 1/4"	53	2.087	41.4	1.630	2	0.079	ECR-WG-NPT114-BL-A	1SNG609024R0000	ENBR-WG-NPT114-BL-A	1SNG609032R0000	250
NPT 1 1/2"	61	2.402	47.2	1.858	2	0.079	ECR-WG-NPT112-BL-A	1SNG609025R0000	ENBR-WG-NPT112-BL-A	1SNG609033R0000	150
NPT 2"	75	2.953	59	2.323	2	0.079	ECR-WG-NPT2-BL-A	1SNG609026R0000	ENBR-WG-NPT2-BL-A	1SNG609034R0000	150

### Washer Gaskets for PG Size

For Thread Size PG	Outer Ø		Inner Ø		Height		CR Black ■		NBR Black ■		Pkg per Box
	D mm	in	ID mm	in	H mm	in	Description	Part Number	Description	Part Number	
PG 7	16.8	0.661	11.8	0.465	1.5	0.059	ECR-WG-PG7-BL-A	1SNG609035R0000	ENBR-WG-PG7-BL-A	1SNG609045R0000	500
PG 9	21.8	0.858	14.5	0.571	1.5	0.059	ECR-WG-PG9-BL-A	1SNG609036R0000	ENBR-WG-PG9-BL-A	1SNG609046R0000	500
PG 11	25.8	1.016	17.5	0.689	1.5	0.059	ECR-WG-PG11-BL-A	1SNG609037R0000	ENBR-WG-PG11-BL-A	1SNG609047R0000	500
PG 13.5	27.8	1.094	19.8	0.780	1.5	0.059	ECR-WG-PG135-BL-A	1SNG609038R0000	ENBR-WG-PG135-BL-A	1SNG609048R0000	500
PG 16	29.8	1.173	21.8	0.858	1.5	0.059	ECR-WG-PG16-BL-A	1SNG609039R0000	ENBR-WG-PG16-BL-A	1SNG609049R0000	500
PG 21	35.8	1.409	27	1.063	1.5	0.059	ECR-WG-PG21-BL-A	1SNG609040R0000	ENBR-WG-PG21-BL-A	1SNG609050R0000	200
PG 29	46.8	1.843	35.5	1.398	1.5	0.059	ECR-WG-PG29-BL-A	1SNG609041R0000	ENBR-WG-PG29-BL-A	1SNG609051R0000	200
PG 36	59	2.323	45.5	1.791	1.5	0.059	ECR-WG-PG36-BL-A	1SNG609042R0000	ENBR-WG-PG36-BL-A	1SNG609052R0000	100
PG 42	66.8	2.630	52.8	2.079	1.5	0.059	ECR-WG-PG42-BL-A	1SNG609043R0000	ENBR-WG-PG42-BL-A	1SNG609053R0000	100
PG 48	71.8	2.827	57.8	2.276	1.5	0.059	ECR-WG-PG48-BL-A	1SNG609044R0000	ENBR-WG-PG48-BL-A	1SNG609054R0000	100

All the main technical data provided are "manufacturer" values

RoHS  
RoHS



# Index

## Part Number Classification

Part Number	Type	Page	Part Number	Type	Page	Part Number	Type	Page
1SNG601001R0000	EP-SG-M12-LGR-A	6	1SNG601067R0000	EP-SG-M20-LGR-G	6	1SNG601133R0000	EP-SG-M40-LGR-F	6
1SNG601002R0000	EP-SG-M12-GR-A	6	1SNG601068R0000	EP-SG-M20-GR-G	6	1SNG601134R0000	EP-SG-M40-GR-F	6
1SNG601003R0000	EP-SG-M12-BL-A	6	1SNG601069R0000	EP-SG-M20-BL-G	6	1SNG601135R0000	EP-SG-M40-BL-F	6
1SNG601004R0000	EP-SG-M12-LGR-B	6	1SNG601070R0000	EP-SG-M20-LGR-H	6	1SNG601136R0000	EP-SG-M50-LGR-A	6
1SNG601005R0000	EP-SG-M12-GR-B	6	1SNG601071R0000	EP-SG-M20-GR-H	6	1SNG601137R0000	EP-SG-M50-GR-A	6
1SNG601006R0000	EP-SG-M12-BL-B	6	1SNG601072R0000	EP-SG-M20-BL-H	6	1SNG601138R0000	EP-SG-M50-BL-A	6
1SNG601007R0000	EP-SG-M12-LGR-C	6	1SNG601073R0000	EP-SG-M20-LGR-I	6	1SNG601139R0000	EP-SG-M50-LGR-B	6
1SNG601008R0000	EP-SG-M12-GR-C	6	1SNG601074R0000	EP-SG-M20-GR-I	6	1SNG601140R0000	EP-SG-M50-GR-B	6
1SNG601009R0000	EP-SG-M12-BL-C	6	1SNG601075R0000	EP-SG-M20-BL-I	6	1SNG601141R0000	EP-SG-M50-BL-B	6
1SNG601010R0000	EP-SG-M12-LGR-D	6	1SNG601076R0000	EP-SG-M25-LGR-A	6	1SNG601142R0000	EP-SG-M63-LGR-A	6
1SNG601011R0000	EP-SG-M12-GR-D	6	1SNG601077R0000	EP-SG-M25-GR-A	6	1SNG601143R0000	EP-SG-M63-GR-A	6
1SNG601012R0000	EP-SG-M12-BL-D	6	1SNG601078R0000	EP-SG-M25-BL-A	6	1SNG601144R0000	EP-SG-M63-BL-A	6
1SNG601013R0000	EP-SG-M12-LGR-E	6	1SNG601079R0000	EP-SG-M25-LGR-B	6	1SNG601145R0000	EP-SG-M63-LGR-B	6
1SNG601014R0000	EP-SG-M12-GR-E	6	1SNG601080R0000	EP-SG-M25-GR-B	6	1SNG601146R0000	EP-SG-M63-GR-B	6
1SNG601015R0000	EP-SG-M12-BL-E	6	1SNG601081R0000	EP-SG-M25-BL-B	6	1SNG601147R0000	EP-SG-M63-BL-B	6
1SNG601016R0000	EP-SG-M12-LGR-F	6	1SNG601082R0000	EP-SG-M25-LGR-C	6	1SNG601148R0000	EP-SG-M75-LGR-A	6
1SNG601017R0000	EP-SG-M12-GR-F	6	1SNG601083R0000	EP-SG-M25-GR-C	6	1SNG601149R0000	EP-SG-M75-GR-A	6
1SNG601018R0000	EP-SG-M12-BL-F	6	1SNG601084R0000	EP-SG-M25-BL-C	6	1SNG601150R0000	EP-SG-M75-BL-A	6
1SNG601019R0000	EP-SG-M16-LGR-A	6	1SNG601085R0000	EP-SG-M25-LGR-D	6	1SNG601151R0000	EP-SG-NPT38-LGR-A	7
1SNG601020R0000	EP-SG-M16-GR-A	6	1SNG601086R0000	EP-SG-M25-GR-D	6	1SNG601152R0000	EP-SG-NPT38-GR-A	7
1SNG601021R0000	EP-SG-M16-BL-A	6	1SNG601087R0000	EP-SG-M25-BL-D	6	1SNG601153R0000	EP-SG-NPT38-BL-A	7
1SNG601022R0000	EP-SG-M16-LGR-B	6	1SNG601088R0000	EP-SG-M25-LGR-E	6	1SNG601154R0000	EP-SG-NPT38-LGR-B	7
1SNG601023R0000	EP-SG-M16-GR-B	6	1SNG601089R0000	EP-SG-M25-GR-E	6	1SNG601155R0000	EP-SG-NPT38-GR-B	7
1SNG601024R0000	EP-SG-M16-BL-B	6	1SNG601090R0000	EP-SG-M25-BL-E	6	1SNG601156R0000	EP-SG-NPT38-BL-B	7
1SNG601025R0000	EP-SG-M16-LGR-C	6	1SNG601091R0000	EP-SG-M25-LGR-F	6	1SNG601157R0000	EP-SG-NPT12-LGR-A	7
1SNG601026R0000	EP-SG-M16-GR-C	6	1SNG601092R0000	EP-SG-M25-GR-F	6	1SNG601158R0000	EP-SG-NPT12-GR-A	7
1SNG601027R0000	EP-SG-M16-BL-C	6	1SNG601093R0000	EP-SG-M25-BL-F	6	1SNG601159R0000	EP-SG-NPT12-BL-A	7
1SNG601028R0000	EP-SG-M16-LGR-D	6	1SNG601094R0000	EP-SG-M25-LGR-G	6	1SNG601160R0000	EP-SG-NPT12-LGR-B	7
1SNG601029R0000	EP-SG-M16-GR-D	6	1SNG601095R0000	EP-SG-M25-GR-G	6	1SNG601161R0000	EP-SG-NPT12-GR-B	7
1SNG601030R0000	EP-SG-M16-BL-D	6	1SNG601096R0000	EP-SG-M25-BL-G	6	1SNG601162R0000	EP-SG-NPT12-BL-B	7
1SNG601031R0000	EP-SG-M16-LGR-E	6	1SNG601097R0000	EP-SG-M25-LGR-H	6	1SNG601163R0000	EP-SG-NPT12-LGR-C	7
1SNG601032R0000	EP-SG-M16-GR-E	6	1SNG601098R0000	EP-SG-M25-GR-H	6	1SNG601164R0000	EP-SG-NPT12-GR-C	7
1SNG601033R0000	EP-SG-M16-BL-E	6	1SNG601099R0000	EP-SG-M32-BL-H	6	1SNG601165R0000	EP-SG-NPT12-BL-C	7
1SNG601034R0000	EP-SG-M16-LGR-F	6	1SNG601100R0000	EP-SG-M32-LGR-A	6	1SNG601166R0000	EP-SG-NPT12-LGR-D	7
1SNG601035R0000	EP-SG-M16-GR-F	6	1SNG601101R0000	EP-SG-M32-GR-A	6	1SNG601167R0000	EP-SG-NPT12-GR-D	7
1SNG601036R0000	EP-SG-M16-BL-F	6	1SNG601102R0000	EP-SG-M32-BL-A	6	1SNG601168R0000	EP-SG-NPT12-BL-D	7
1SNG601037R0000	EP-SG-M16-LGR-G	6	1SNG601103R0000	EP-SG-M32-LGR-B	6	1SNG601169R0000	EP-SG-NPT34-LGR-A	7
1SNG601038R0000	EP-SG-M16-GR-G	6	1SNG601104R0000	EP-SG-M32-GR-B	6	1SNG601170R0000	EP-SG-NPT34-GR-A	7
1SNG601039R0000	EP-SG-M16-BL-G	6	1SNG601105R0000	EP-SG-M32-BL-B	6	1SNG601171R0000	EP-SG-NPT34-BL-A	7
1SNG601040R0000	EP-SG-M16-LGR-H	6	1SNG601106R0000	EP-SG-M32-LGR-C	6	1SNG601172R0000	EP-SG-NPT34-GR-B	7
1SNG601041R0000	EP-SG-M16-GR-H	6	1SNG601107R0000	EP-SG-M32-GR-C	6	1SNG601173R0000	EP-SG-NPT34-GR-B	7
1SNG601042R0000	EP-SG-M16-BL-H	6	1SNG601108R0000	EP-SG-M32-BL-C	6	1SNG601174R0000	EP-SG-NPT34-BL-B	7
1SNG601043R0000	EP-SG-M16-LGR-I	6	1SNG601109R0000	EP-SG-M32-LGR-D	6	1SNG601175R0000	EP-SG-NPT1-LGR-A	7
1SNG601044R0000	EP-SG-M16-GR-I	6	1SNG601110R0000	EP-SG-M32-GR-D	6	1SNG601176R0000	EP-SG-NPT1-GR-A	7
1SNG601045R0000	EP-SG-M16-BL-I	6	1SNG601111R0000	EP-SG-M32-BL-D	6	1SNG601177R0000	EP-SG-NPT1-BL-A	7
1SNG601046R0000	EP-SG-M16-LGR-J	6	1SNG601112R0000	EP-SG-M32-LGR-E	6	1SNG601178R0000	EP-SG-NPT1-LGR-B	7
1SNG601047R0000	EP-SG-M16-GR-J	6	1SNG601113R0000	EP-SG-M32-GR-E	6	1SNG601179R0000	EP-SG-NPT1-GR-B	7
1SNG601048R0000	EP-SG-M16-BL-J	6	1SNG601114R0000	EP-SG-M32-BL-E	6	1SNG601180R0000	EP-SG-NPT1-BL-B	7
1SNG601049R0000	EP-SG-M20-LGR-A	6	1SNG601115R0000	EP-SG-M32-LGR-F	6	1SNG601181R0000	EP-SG-PG7-LGR-A	7
1SNG601050R0000	EP-SG-M20-GR-A	6	1SNG601116R0000	EP-SG-M32-GR-F	6	1SNG601182R0000	EP-SG-PG7-GR-A	7
1SNG601051R0000	EP-SG-M20-BL-A	6	1SNG601117R0000	EP-SG-M32-BL-F	6	1SNG601183R0000	EP-SG-PG7-BL-A	7
1SNG601052R0000	EP-SG-M20-LGR-B	6	1SNG601118R0000	EP-SG-M40-LGR-A	6	1SNG601184R0000	EP-SG-PG7-LGR-B	7
1SNG601053R0000	EP-SG-M20-GR-B	6	1SNG601119R0000	EP-SG-M40-GR-A	6	1SNG601185R0000	EP-SG-PG7-GR-B	7
1SNG601054R0000	EP-SG-M20-BL-B	6	1SNG601120R0000	EP-SG-M40-BL-A	6	1SNG601186R0000	EP-SG-PG7-BL-B	7
1SNG601055R0000	EP-SG-M20-LGR-C	6	1SNG601121R0000	EP-SG-M40-LGR-B	6	1SNG601187R0000	EP-SG-PG9-LGR-A	7
1SNG601056R0000	EP-SG-M20-GR-C	6	1SNG601122R0000	EP-SG-M40-GR-B	6	1SNG601188R0000	EP-SG-PG9-GR-A	7
1SNG601057R0000	EP-SG-M20-BL-C	6	1SNG601123R0000	EP-SG-M40-BL-B	6	1SNG601189R0000	EP-SG-PG9-BL-A	7
1SNG601058R0000	EP-SG-M20-LGR-D	6	1SNG601124R0000	EP-SG-M40-LGR-C	6	1SNG601190R0000	EP-SG-PG9-LGR-B	7
1SNG601059R0000	EP-SG-M20-GR-D	6	1SNG601125R0000	EP-SG-M40-GR-C	6	1SNG601191R0000	EP-SG-PG9-GR-B	7
1SNG601060R0000	EP-SG-M20-BL-D	6	1SNG601126R0000	EP-SG-M40-BL-C	6	1SNG601192R0000	EP-SG-PG9-BL-B	7
1SNG601061R0000	EP-SG-M20-LGR-E	6	1SNG601127R0000	EP-SG-M40-LGR-D	6	1SNG601193R0000	EP-SG-PG11-LGR-A	7
1SNG601062R0000	EP-SG-M20-GR-E	6	1SNG601128R0000	EP-SG-M40-GR-D	6	1SNG601194R0000	EP-SG-PG11-GR-A	7
1SNG601063R0000	EP-SG-M20-BL-E	6	1SNG601129R0000	EP-SG-M40-BL-D	6	1SNG601195R0000	EP-SG-PG11-BL-A	7
1SNG601064R0000	EP-SG-M20-LGR-F	6	1SNG601130R0000	EP-SG-M40-LGR-E	6	1SNG601196R0000	EP-SG-PG11-LGR-B	7
1SNG601065R0000	EP-SG-M20-GR-F	6	1SNG601131R0000	EP-SG-M40-GR-E	6	1SNG601197R0000	EP-SG-PG11-GR-B	7
1SNG601066R0000	EP-SG-M20-BL-F	6	1SNG601132R0000	EP-SG-M40-BL-E	6	1SNG601198R0000	EP-SG-PG11-BL-B	7

# Index

## Part Number Classification

Part Number	Type	Page	Part Number	Type	Page	Part Number	Type	Page
1SNG601199R0000	EP-SG-PG135-LGR-A	7	1SNG602025R0000	EM-SG-M25-MET-E	10	1SNG602091R0000	EM-SG-PG11-MET-A	11
1SNG601200R0000	EP-SG-PG135-GR-A	7	1SNG602026R0000	EM-SG-M25-MET-F	10	1SNG602092R0000	EM-SG-PG11-MET-B	11
1SNG601201R0000	EP-SG-PG135-BL-A	7	1SNG602027R0000	EM-SG-M25-MET-G	10	1SNG602093R0000	EM-SG-PG11-MET-C	11
1SNG601202R0000	EP-SG-PG135-LGR-B	7	1SNG602028R0000	EM-SG-M25-MET-H	10	1SNG602094R0000	EM-SG-PG11-MET-D	11
1SNG601203R0000	EP-SG-PG135-GR-B	7	1SNG602029R0000	EM-SG-M25-MET-I	10	1SNG602095R0000	EM-SG-PG135-MET-A	11
1SNG601204R0000	EP-SG-PG135-BL-B	7	1SNG602030R0000	EM-SG-M25-MET-J	10	1SNG602096R0000	EM-SG-PG135-MET-B	11
1SNG601205R0000	EP-SG-PG16-LGR-A	7	1SNG602031R0000	EM-SG-M32-MET-A	10	1SNG602097R0000	EM-SG-PG135-MET-C	11
1SNG601206R0000	EP-SG-PG16-GR-A	7	1SNG602032R0000	EM-SG-M32-MET-B	10	1SNG602098R0000	EM-SG-PG135-MET-D	11
1SNG601207R0000	EP-SG-PG16-BL-A	7	1SNG602033R0000	EM-SG-M32-MET-C	10	1SNG602099R0000	EM-SG-PG16-MET-A	11
1SNG601208R0000	EP-SG-PG16-LGR-B	7	1SNG602034R0000	EM-SG-M32-MET-D	10	1SNG602100R0000	EM-SG-PG16-MET-B	11
1SNG601209R0000	EP-SG-PG16-GR-B	7	1SNG602035R0000	EM-SG-M32-MET-E	10	1SNG602101R0000	EM-SG-PG16-MET-C	11
1SNG601210R0000	EP-SG-PG16-BL-B	7	1SNG602036R0000	EM-SG-M32-MET-F	10	1SNG602102R0000	EM-SG-PG16-MET-D	11
1SNG601211R0000	EP-SG-PG21-LGR-A	7	1SNG602037R0000	EM-SG-M32-MET-G	10	1SNG602103R0000	EM-SG-PG21-MET-A	11
1SNG601212R0000	EP-SG-PG21-GR-A	7	1SNG602038R0000	EM-SG-M32-MET-H	10	1SNG602104R0000	EM-SG-PG21-MET-B	11
1SNG601213R0000	EP-SG-PG21-BL-A	7	1SNG602039R0000	EM-SG-M32-MET-I	10	1SNG602105R0000	EM-SG-PG21-MET-C	11
1SNG601214R0000	EP-SG-PG21-LGR-B	7	1SNG602040R0000	EM-SG-M32-MET-J	10	1SNG602106R0000	EM-SG-PG21-MET-D	11
1SNG601215R0000	EP-SG-PG21-GR-B	7	1SNG602041R0000	EM-SG-M40-MET-A	10	1SNG602107R0000	EM-SG-PG29-MET-A	11
1SNG601216R0000	EP-SG-PG21-BL-B	7	1SNG602042R0000	EM-SG-M40-MET-B	10	1SNG602108R0000	EM-SG-PG29-MET-B	11
1SNG601217R0000	EP-SG-PG29-LGR-A	7	1SNG602043R0000	EM-SG-M40-MET-C	10	1SNG602109R0000	EM-SG-PG29-MET-C	11
1SNG601218R0000	EP-SG-PG29-GR-A	7	1SNG602044R0000	EM-SG-M40-MET-D	10	1SNG602110R0000	EM-SG-PG29-MET-D	11
1SNG601219R0000	EP-SG-PG29-BL-A	7	1SNG602045R0000	EM-SG-M40-MET-E	10	1SNG602111R0000	EM-SG-PG36-MET-A	11
1SNG601220R0000	EP-SG-PG29-LGR-B	7	1SNG602046R0000	EM-SG-M40-MET-F	10	1SNG602112R0000	EM-SG-PG36-MET-B	11
1SNG601221R0000	EP-SG-PG29-GR-B	7	1SNG602047R0000	EM-SG-M40-MET-G	10	1SNG602113R0000	EM-SG-PG36-MET-C	11
1SNG601222R0000	EP-SG-PG29-BL-B	7	1SNG602048R0000	EM-SG-M40-MET-H	10	1SNG602114R0000	EM-SG-PG36-MET-D	11
1SNG601223R0000	EP-SG-PG36-LGR-A	7	1SNG602049R0000	EM-SG-M40-MET-I	10	1SNG602115R0000	EM-SG-PG42-MET-A	11
1SNG601224R0000	EP-SG-PG36-GR-A	7	1SNG602050R0000	EM-SG-M40-MET-J	10	1SNG602116R0000	EM-SG-PG42-MET-B	11
1SNG601225R0000	EP-SG-PG36-BL-A	7	1SNG602051R0000	EM-SG-M50-MET-A	10	1SNG602117R0000	EM-SG-PG42-MET-C	11
1SNG601226R0000	EP-SG-PG36-LGR-B	7	1SNG602052R0000	EM-SG-M50-MET-B	10	1SNG602118R0000	EM-SG-PG42-MET-D	11
1SNG601227R0000	EP-SG-PG36-GR-B	7	1SNG602053R0000	EM-SG-M50-MET-C	10	1SNG602119R0000	EM-SG-PG48-MET-A	11
1SNG601228R0000	EP-SG-PG36-BL-B	7	1SNG602054R0000	EM-SG-M50-MET-D	10	1SNG602120R0000	EM-SG-PG48-MET-B	11
1SNG601229R0000	EP-SG-PG42-LGR-A	7	1SNG602055R0000	EM-SG-M50-MET-E	10	1SNG602121R0000	EM-SG-PG48-MET-C	11
1SNG601230R0000	EP-SG-PG42-GR-A	7	1SNG602056R0000	EM-SG-M50-MET-F	10	1SNG602122R0000	EM-SG-PG48-MET-D	11
1SNG601231R0000	EP-SG-PG42-BL-A	7	1SNG602057R0000	EM-SG-M50-MET-G	10	1SNG603001R0000	EP-BRM-SZ0-LGR-A	27
1SNG601232R0000	EP-SG-PG42-LGR-B	7	1SNG602058R0000	EM-SG-M50-MET-H	10	1SNG603002R0000	EP-BRM-SZ0-BL-A	27
1SNG601233R0000	EP-SG-PG42-GR-B	7	1SNG602059R0000	EM-SG-M63-MET-A	10	1SNG603003R0000	EP-BRM-SZ12-LGR-A	27
1SNG601234R0000	EP-SG-PG42-BL-B	7	1SNG602060R0000	EM-SG-M63-MET-B	10	1SNG603004R0000	EP-BRM-SZ12-BL-A	27
1SNG601235R0000	EP-SG-PG48-LGR-A	7	1SNG602061R0000	EM-SG-M63-MET-C	10	1SNG603005R0000	EP-BRM-SZ14-LGR-A	27
1SNG601236R0000	EP-SG-PG48-GR-A	7	1SNG602062R0000	EM-SG-M63-MET-D	10	1SNG603006R0000	EP-BRM-SZ14-BL-A	27
1SNG601237R0000	EP-SG-PG48-BL-A	7	1SNG602063R0000	EM-SG-M63-MET-E	10	1SNG603007R0000	EP-BRM-SZ22-LGR-A	27
1SNG601238R0000	EP-SG-PG48-LGR-B	7	1SNG602064R0000	EM-SG-M63-MET-F	10	1SNG603008R0000	EP-BRM-SZ22-BL-A	27
1SNG601239R0000	EP-SG-PG48-GR-B	7	1SNG602065R0000	EM-SG-M63-MET-G	10	1SNG603009R0000	EP-BRM-SZ23-LGR-A	27
1SNG601240R0000	EP-SG-PG48-BL-B	7	1SNG602066R0000	EM-SG-M63-MET-H	10	1SNG603010R0000	EP-BRM-SZ23-BL-A	27
1SNG602001R0000	EM-SG-M12-MET-A	10	1SNG602067R0000	EM-SG-M63-MET-I	10	1SNG603011R0000	EP-BRM-SZ29-LGR-A	27
1SNG602002R0000	EM-SG-M12-MET-B	10	1SNG602068R0000	EM-SG-NPT38-MET-A	11	1SNG603012R0000	EP-BRM-SZ29-BL-A	27
1SNG602003R0000	EM-SG-M12-MET-C	10	1SNG602069R0000	EM-SG-NPT38-MET-B	11	1SNG604001R0000	EP-BPA-SZ4-LGR-A	26
1SNG602004R0000	EM-SG-M12-MET-D	10	1SNG602070R0000	EM-SG-NPT38-MET-C	11	1SNG604002R0000	EP-BPA-SZ4-BL-A	26
1SNG602005R0000	EM-SG-M16-MET-A	10	1SNG602071R0000	EM-SG-NPT38-MET-D	11	1SNG604003R0000	EP-BPA-SZ7-LGR-A	26
1SNG602006R0000	EM-SG-M16-MET-B	10	1SNG602072R0000	EM-SG-NPT12-MET-A	11	1SNG604004R0000	EP-BPA-SZ7-BL-A	26
1SNG602007R0000	EM-SG-M16-MET-C	10	1SNG602073R0000	EM-SG-NPT12-MET-B	11	1SNG604005R0000	EP-BPA-SZ10-LGR-A	26
1SNG602008R0000	EM-SG-M16-MET-D	10	1SNG602074R0000	EM-SG-NPT12-MET-C	11	1SNG604006R0000	EP-BPA-SZ10-BL-A	26
1SNG602009R0000	EM-SG-M16-MET-E	10	1SNG602075R0000	EM-SG-NPT12-MET-D	11	1SNG604007R0000	EP-BPA-SZ1-BL-A	26
1SNG602010R0000	EM-SG-M16-MET-F	10	1SNG602076R0000	EM-SG-NPT34-MET-A	11	1SNG604008R0000	EP-BPA-SZ2-BL-A	26
1SNG602011R0000	EM-SG-M16-MET-G	10	1SNG602077R0000	EM-SG-NPT34-MET-B	11	1SNG604009R0000	EP-BPA-SZ3-BL-A	26
1SNG602012R0000	EM-SG-M16-MET-H	10	1SNG602078R0000	EM-SG-NPT1-MET-A	11	1SNG604010R0000	EP-BPA-SZ4-BL-A	26
1SNG602013R0000	EM-SG-M16-MET-I	10	1SNG602079R0000	EM-SG-NPT1-MET-B	11	1SNG605001R0000	EP-VEP-M6-LGR-A	29
1SNG602014R0000	EM-SG-M20-MET-A	10	1SNG602080R0000	EM-SG-NPT114-MET-A	11	1SNG605002R0000	EP-VEP-M6-GR-A	29
1SNG602015R0000	EM-SG-M20-MET-B	10	1SNG602081R0000	EM-SG-NPT112-MET-A	11	1SNG605003R0000	EP-VEP-M6-BL-A	29
1SNG602016R0000	EM-SG-M20-MET-C	10	1SNG602082R0000	EM-SG-NPT2-MET-A	11	1SNG605004R0000	EP-VEP-M8-LGR-A	29
1SNG602017R0000	EM-SG-M20-MET-D	10	1SNG602083R0000	EM-SG-PG7-MET-A	11	1SNG605005R0000	EP-VEP-M8-GR-A	29
1SNG602018R0000	EM-SG-M20-MET-E	10	1SNG602084R0000	EM-SG-PG7-MET-B	11	1SNG605006R0000	EP-VEP-M8-BL-A	29
1SNG602019R0000	EM-SG-M20-MET-F	10	1SNG602085R0000	EM-SG-PG7-MET-C	11	1SNG605007R0000	EP-BPA-SZ10-LGR-A	29
1SNG602020R0000	EM-SG-M20-MET-G	10	1SNG602086R0000	EM-SG-PG7-MET-D	11	1SNG605008R0000	EP-VEP-M1210-GR-A	29
1SNG602021R0000	EM-SG-M25-MET-A	10	1SNG602087R0000	EM-SG-PG9-MET-A	11	1SNG605009R0000	EP-VEP-M1210-BL-A	29
1SNG602022R0000	EM-SG-M25-MET-B	10	1SNG602088R0000	EM-SG-PG9-MET-B	11	1SNG605010R0000	EP-VEP-M1210-LGR-B	29
1SNG602023R0000	EM-SG-M25-MET-C	10	1SNG602089R0000	EM-SG-PG9-MET-C	11	1SNG605011R0000	EP-VEP-M1210-GR-B	29
1SNG602024R0000	EM-SG-M25-MET-D	10	1SNG602090R0000	EM-SG-PG9-MET-D	11	1SNG605012R0000	EP-VEP-M1210-BL-B	29



# Index

## Part Number Classification

Part Number	Type	Page	Part Number	Type	Page	Part Number	Type	Page
1SNG605013R0000	EP-VEP-M1210-LGR-C	29	1SNG605079R0000	EP-VEP-M20-LGR-D	29	1SNG607027R0000	EP-LN-M75-BL-A	36
1SNG605014R0000	EP-VEP-M1210-GR-C	29	1SNG605080R0000	EP-VEP-M20-GR-D	29	1SNG607028R0000	EP-LN-NPT38-LGR-A	36
1SNG605015R0000	EP-VEP-M1210-BL-C	29	1SNG605081R0000	EP-VEP-M20-BL-D	29	1SNG607029R0000	EP-LN-NPT38-GR-A	36
1SNG605016R0000	EP-VEP-M1210-LGR-D	29	1SNG605082R0000	EP-VEP-M40-LGR-A	29	1SNG607030R0000	EP-LN-NPT38-BL-A	36
1SNG605017R0000	EP-VEP-M1210-GR-D	29	1SNG605083R0000	EP-VEP-M40-GR-A	29	1SNG607031R0000	EP-LN-NPT12-LGR-A	36
1SNG605018R0000	EP-VEP-M1210-BL-D	29	1SNG605084R0000	EP-VEP-M40-BL-A	29	1SNG607032R0000	EP-LN-NPT12-GR-A	36
1SNG605019R0000	EP-VEP-M12-LGR-A	29	1SNG605085R0000	EP-VEP-M40-LGR-B	29	1SNG607033R0000	EP-LN-NPT12-BL-A	36
1SNG605020R0000	EP-VEP-M12-GR-A	29	1SNG605086R0000	EP-VEP-M40-GR-B	29	1SNG607034R0000	EP-LN-NPT34-LGR-A	36
1SNG605021R0000	EP-VEP-M12-BL-A	29	1SNG605087R0000	EP-VEP-M40-BL-B	29	1SNG607035R0000	EP-LN-NPT34-GR-A	36
1SNG605022R0000	EP-VEP-M12-LGR-B	29	1SNG605088R0000	EP-VEP-M40-LGR-C	29	1SNG607036R0000	EP-LN-NPT34-BL-A	36
1SNG605023R0000	EP-VEP-M12-GR-B	29	1SNG605089R0000	EP-VEP-M40-GR-C	29	1SNG607037R0000	EP-LN-NPT1-LGR-A	36
1SNG605024R0000	EP-VEP-M12-BL-B	29	1SNG605090R0000	EP-VEP-M40-BL-C	29	1SNG607038R0000	EP-LN-NPT1-GR-A	36
1SNG605025R0000	EP-VEP-M12-LGR-C	29	1SNG605091R0000	EP-VEP-M40-LGR-D	29	1SNG607039R0000	EP-LN-NPT1-BL-A	36
1SNG605026R0000	EP-VEP-M12-GR-C	29	1SNG605092R0000	EP-VEP-M40-GR-D	29	1SNG607040R0000	EP-LN-PG7-LGR-A	36
1SNG605027R0000	EP-VEP-M12-BL-C	29	1SNG605093R0000	EP-VEP-M40-BL-D	29	1SNG607041R0000	EP-LN-PG7-GR-A	36
1SNG605028R0000	EP-VEP-M12-LGR-D	29	1SNG605094R0000	EP-VEP-SFAF16-LGR-A	29	1SNG607042R0000	EP-LN-PG7-BL-A	36
1SNG605029R0000	EP-VEP-M12-GR-D	29	1SNG605095R0000	EP-VEP-SFAF16-GR-A	29	1SNG607043R0000	EP-LN-PG9-LGR-A	36
1SNG605030R0000	EP-VEP-M12-BL-D	29	1SNG605096R0000	EP-VEP-SFAF16-BL-A	29	1SNG607044R0000	EP-LN-PG9-GR-A	36
1SNG605031R0000	EP-VEP-M12-LGR-E	29	1SNG605097R0000	EP-VEP-SFAF25-LGR-A	29	1SNG607045R0000	EP-LN-PG9-BL-A	36
1SNG605032R0000	EP-VEP-M12-GR-E	29	1SNG605098R0000	EP-VEP-SFAF25-GR-A	29	1SNG607046R0000	EP-LN-PG11-LGR-A	36
1SNG605033R0000	EP-VEP-M12-BL-E	29	1SNG605099R0000	EP-VEP-SFAF25-BL-A	29	1SNG607047R0000	EP-LN-PG11-GR-A	36
1SNG605034R0000	EP-VEP-M12-LGR-F	29	1SNG605100R0000	EP-VEP-SFAF120-LGR-A	29	1SNG607048R0000	EP-LN-PG11-BL-A	36
1SNG605035R0000	EP-VEP-M12-GR-F	29	1SNG605101R0000	EP-VEP-SFAF120-GR-A	29	1SNG607049R0000	EP-LN-PG135-LGR-A	36
1SNG605036R0000	EP-VEP-M12-BL-F	29	1SNG605102R0000	EP-VEP-SFAF120-BL-A	29	1SNG607050R0000	EP-LN-PG135-GR-A	36
1SNG605037R0000	EP-VEP-M12-LGR-G	29	1SNG605103R0000	EP-VEP-SFAF300-LGR-A	29	1SNG607051R0000	EP-LN-PG135-BL-A	36
1SNG605038R0000	EP-VEP-M12-GR-G	29	1SNG605104R0000	EP-VEP-SFAF300-GR-A	29	1SNG607052R0000	EP-LN-PG16-LGR-A	36
1SNG605039R0000	EP-VEP-M12-BL-G	29	1SNG605105R0000	EP-VEP-SFAF300-BL-A	29	1SNG607053R0000	EP-LN-PG16-GR-A	36
1SNG605040R0000	EP-VEP-M12-LGR-H	29	1SNG605106R0000	EP-VEP-SFAF15-LGR-A	29	1SNG607054R0000	EP-LN-PG16-BL-A	36
1SNG605041R0000	EP-VEP-M12-GR-H	29	1SNG605107R0000	EP-VEP-SFAF15-GR-A	29	1SNG607055R0000	EP-LN-PG21-LGR-A	36
1SNG605042R0000	EP-VEP-M12-BL-H	29	1SNG605108R0000	EP-VEP-SFAF15-BL-A	29	1SNG607056R0000	EP-LN-PG21-GR-A	36
1SNG605043R0000	EP-VEP-M12-LGR-I	29	1SNG605109R0000	EP-VEP-SFAF25-LGR-B	29	1SNG607057R0000	EP-LN-PG21-BL-A	36
1SNG605044R0000	EP-VEP-M12-GR-I	29	1SNG605110R0000	EP-VEP-SFAF25-GR-B	29	1SNG607058R0000	EP-LN-PG29-LGR-A	36
1SNG605045R0000	EP-VEP-M12-BL-I	29	1SNG605111R0000	EP-VEP-SFAF25-BL-B	29	1SNG607059R0000	EP-LN-PG29-GR-A	36
1SNG605046R0000	EP-VEP-M12-LGR-J	29	1SNG606001R0000	EM-RG-M12-MET-A	21	1SNG607060R0000	EP-LN-PG29-BL-A	36
1SNG605047R0000	EP-VEP-M12-GR-J	29	1SNG606002R0000	EM-RG-M16-MET-A	21	1SNG607061R0000	EP-LN-PG36-LGR-A	36
1SNG605048R0000	EP-VEP-M12-BL-J	29	1SNG606003R0000	EM-RG-M20-MET-A	21	1SNG607062R0000	EP-LN-PG36-GR-A	36
1SNG605049R0000	EP-VEP-M12-LGR-K	29	1SNG606004R0000	EM-RG-M20-MET-B	21	1SNG607063R0000	EP-LN-PG36-BL-A	36
1SNG605050R0000	EP-VEP-M12-GR-K	29	1SNG606005R0000	EM-RG-M25-MET-A	21	1SNG607064R0000	EP-LN-PG42-LGR-A	36
1SNG605051R0000	EP-VEP-M12-BL-K	29	1SNG606006R0000	EM-RG-M32-MET-A	21	1SNG607065R0000	EP-LN-PG42-GR-A	36
1SNG605052R0000	EP-VEP-M12-LGR-L	29	1SNG606007R0000	EM-RG-M40-MET-A	21	1SNG607066R0000	EP-LN-PG42-BL-A	36
1SNG605053R0000	EP-VEP-M12-GR-L	29	1SNG607001R0000	EP-LN-M12-LGR-A	36	1SNG607067R0000	EP-LN-PG48-LGR-A	36
1SNG605054R0000	EP-VEP-M12-BL-L	29	1SNG607002R0000	EP-LN-M12-GR-A	36	1SNG607068R0000	EP-LN-PG48-GR-A	36
1SNG605055R0000	EP-VEP-M12-LGR-M	29	1SNG607003R0000	EP-LN-M12-BL-A	36	1SNG607069R0000	EP-LN-PG48-BL-A	36
1SNG605056R0000	EP-VEP-M12-GR-M	29	1SNG607004R0000	EP-LN-M16-LGR-A	36	1SNG608001R0000	EM-LN-M12-MET-A	37
1SNG605057R0000	EP-VEP-M12-BL-M	29	1SNG607005R0000	EP-LN-M16-GR-A	36	1SNG608002R0000	EM-LN-M16-MET-A	37
1SNG605058R0000	EP-VEP-M16-LGR-A	29	1SNG607006R0000	EP-LN-M16-BL-A	36	1SNG608003R0000	EM-LN-M20-MET-A	37
1SNG605059R0000	EP-VEP-M16-GR-A	29	1SNG607007R0000	EP-LN-M20-LGR-A	36	1SNG608004R0000	EM-LN-M25-MET-A	37
1SNG605060R0000	EP-VEP-M16-BL-A	29	1SNG607008R0000	EP-LN-M20-GR-A	36	1SNG608005R0000	EM-LN-M32-MET-A	37
1SNG605061R0000	EP-VEP-M16-LGR-B	29	1SNG607009R0000	EP-LN-M20-BL-A	36	1SNG608006R0000	EM-LN-M40-MET-A	37
1SNG605062R0000	EP-VEP-M16-GR-B	29	1SNG607010R0000	EP-LN-M25-LGR-A	36	1SNG608007R0000	EM-LN-M50-MET-A	37
1SNG605063R0000	EP-VEP-M16-BL-B	29	1SNG607011R0000	EP-LN-M25-GR-A	36	1SNG608008R0000	EM-LN-M63-MET-A	37
1SNG605064R0000	EP-VEP-M16-LGR-C	29	1SNG607012R0000	EP-LN-M25-BL-A	36	1SNG608009R0000	EM-LN-NPT14-MET-A	37
1SNG605065R0000	EP-VEP-M16-GR-C	29	1SNG607013R0000	EP-LN-M32-LGR-A	36	1SNG608010R0000	EM-LN-NPT38-MET-A	37
1SNG605066R0000	EP-VEP-M16-BL-C	29	1SNG607014R0000	EP-LN-M32-GR-A	36	1SNG608011R0000	EM-LN-NPT12-MET-A	37
1SNG605067R0000	EP-VEP-M16-LGR-D	29	1SNG607015R0000	EP-LN-M32-BL-A	36	1SNG608012R0000	EM-LN-NPT34-MET-A	37
1SNG605068R0000	EP-VEP-M16-GR-D	29	1SNG607016R0000	EP-LN-M40-LGR-A	36	1SNG608013R0000	EM-LN-NPT1-MET-A	37
1SNG605069R0000	EP-VEP-M16-BL-D	29	1SNG607017R0000	EP-LN-M40-GR-A	36	1SNG608014R0000	EM-LN-NPT114-MET-A	37
1SNG605070R0000	EP-VEP-M20-LGR-A	29	1SNG607018R0000	EP-LN-M40-BL-A	36	1SNG608015R0000	EM-LN-NPT112-MET-A	37
1SNG605071R0000	EP-VEP-M20-GR-A	29	1SNG607019R0000	EP-LN-M50-LGR-A	36	1SNG608016R0000	EM-LN-NPT2-MET-A	37
1SNG605072R0000	EP-VEP-M20-BL-A	29	1SNG607020R0000	EP-LN-M50-GR-A	36	1SNG608017R0000	EM-LN-PG7-MET-A	37
1SNG605073R0000	EP-VEP-M20-LGR-B	29	1SNG607021R0000	EP-LN-M50-BL-A	36	1SNG608018R0000	EM-LN-PG9-MET-A	37
1SNG605074R0000	EP-VEP-M20-GR-B	29	1SNG607022R0000	EP-LN-M63-LGR-A	36	1SNG608019R0000	EM-LN-PG11-MET-A	37
1SNG605075R0000	EP-VEP-M20-BL-B	29	1SNG607023R0000	EP-LN-M63-GR-A	36	1SNG608020R0000	EM-LN-PG135-MET-A	37
1SNG605076R0000	EP-VEP-M20-LGR-C	29	1SNG607024R0000	EP-LN-M63-BL-A	36	1SNG608021R0000	EM-LN-PG16-MET-A	37
1SNG605077R0000	EP-VEP-M20-GR-C	29	1SNG607025R0000	EP-LN-M75-LGR-A	36	1SNG608022R0000	EM-LN-PG21-MET-A	37
1SNG605078R0000	EP-VEP-M20-BL-C	29	1SNG607026R0000	EP-LN-M75-GR-A	36	1SNG608023R0000	EM-LN-PG29-MET-A	37

# Index

## Part Number Classification

Part Number	Type	Page	Part Number	Type	Page	Part Number	Type	Page
1SNG608024R0000	EM-LN-PG36-MET-A	37	1SNG610010R0000	EP-DOP-SZ11-LGR-B	35	1SNG610076R0000	EP-DOP-SZ45-LGR-A	35
1SNG608025R0000	EM-LN-PG42-MET-A	37	1SNG610011R0000	EP-DOP-SZ11-GR-B	35	1SNG610077R0000	EP-DOP-SZ45-GR-A	35
1SNG608026R0000	EM-LN-PG48-MET-A	37	1SNG610012R0000	EP-DOP-SZ11-BL-B	35	1SNG610078R0000	EP-DOP-SZ45-BL-A	35
1SNG609001R0000	ECR-WG-M12-BL-A	38	1SNG610013R0000	EP-DOP-SZ13-LGR-A	35	1SNG610079R0000	EP-DOP-SZ45-LGR-B	35
1SNG609002R0000	ECR-WG-M16-BL-A	38	1SNG610014R0000	EP-DOP-SZ13-GR-A	35	1SNG610080R0000	EP-DOP-SZ45-GR-B	35
1SNG609003R0000	ECR-WG-M20-BL-A	38	1SNG610015R0000	EP-DOP-SZ13-BL-A	35	1SNG610081R0000	EP-DOP-SZ45-BL-B	35
1SNG609004R0000	ECR-WG-M25-BL-A	38	1SNG610016R0000	EP-DOP-SZ13-LGR-B	35	1SNG610082R0000	EP-DOP-SZ52-LGR-A	35
1SNG609005R0000	ECR-WG-M32-BL-A	38	1SNG610017R0000	EP-DOP-SZ13-GR-B	35	1SNG610083R0000	EP-DOP-SZ52-GR-A	35
1SNG609006R0000	ECR-WG-M40-BL-A	38	1SNG610018R0000	EP-DOP-SZ13-BL-B	35	1SNG610084R0000	EP-DOP-SZ52-BL-A	35
1SNG609007R0000	ECR-WG-M50-BL-A	38	1SNG610019R0000	EP-DOP-SZ13-LGR-C	35	1SNG610085R0000	EP-DOP-SZ52-LGR-B	35
1SNG609008R0000	ECR-WG-M63-BL-A	38	1SNG610020R0000	EP-DOP-SZ13-GR-C	35	1SNG610086R0000	EP-DOP-SZ52-GR-B	35
1SNG609009R0000	ECR-WG-M75-BL-A	38	1SNG610021R0000	EP-DOP-SZ13-BL-C	35	1SNG610087R0000	EP-DOP-SZ52-BL-B	35
1SNG609010R0000	ENBR-WG-M12-BL-A	38	1SNG610022R0000	EP-DOP-SZ16-LGR-A	35	1SNG611001R0000	EP-DRP-M12-LGR-A	31
1SNG609011R0000	ENBR-WG-M16-BL-A	38	1SNG610023R0000	EP-DOP-SZ16-GR-A	35	1SNG611002R0000	EP-DRP-M12-GR-A	31
1SNG609012R0000	ENBR-WG-M20-BL-A	38	1SNG610024R0000	EP-DOP-SZ16-BL-A	35	1SNG611003R0000	EP-DRP-M12-BL-A	31
1SNG609013R0000	ENBR-WG-M25-BL-A	38	1SNG610025R0000	EP-DOP-SZ16-LGR-B	35	1SNG611004R0000	EP-DRP-M12-LGR-B	31
1SNG609014R0000	ENBR-WG-M32-BL-A	38	1SNG610026R0000	EP-DOP-SZ16-GR-B	35	1SNG611005R0000	EP-DRP-M12-GR-B	31
1SNG609015R0000	ENBR-WG-M40-BL-A	38	1SNG610027R0000	EP-DOP-SZ16-BL-B	35	1SNG611006R0000	EP-DRP-M12-BL-B	31
1SNG609016R0000	ENBR-WG-M50-BL-A	38	1SNG610028R0000	EP-DOP-SZ16-LGR-C	35	1SNG612001R0000	EM-DRP-NPT34-MET-A	31
1SNG609017R0000	ENBR-WG-M63-BL-A	38	1SNG610029R0000	EP-DOP-SZ16-GR-C	35	1SNG612002R0000	EM-DRP-M25-MET-A	31
1SNG609018R0000	ENBR-WG-M75-BL-A	38	1SNG610030R0000	EP-DOP-SZ16-BL-C	35	1SNG612003R0000	EM-DRP-NPT12-MET-A	31
1SNG609019R0000	ECR-WG-NPT14-BL-A	38	1SNG610031R0000	EP-DOP-SZ16-LGR-D	35	1SNG612004R0000	EM-DRP-NPT34-MET-A	31
1SNG609020R0000	ECR-WG-NPT38-BL-A	38	1SNG610032R0000	EP-DOP-SZ16-GR-D	35	1SNG612005R0000	EM-DRP-M20-MET-B	31
1SNG609021R0000	ECR-WG-NPT12-BL-A	38	1SNG610033R0000	EP-DOP-SZ16-BL-D	35	1SNG612006R0000	EM-DRP-M25-MET-B	31
1SNG609022R0000	ECR-WG-NPT34-BL-A	38	1SNG610034R0000	EP-DOP-SZ18-LGR-A	35	1SNG612007R0000	EM-DRP-NPT12-MET-B	31
1SNG609023R0000	ECR-WG-NPT1-BL-A	38	1SNG610035R0000	EP-DOP-SZ18-GR-A	35	1SNG612008R0000	EM-DRP-NPT34-MET-B	31
1SNG609024R0000	ECR-WG-NPT114-BL-A	38	1SNG610036R0000	EP-DOP-SZ18-BL-A	35	1SNG613001R0000	EM-EMC2-M12-MET-A	18
1SNG609025R0000	ECR-WG-NPT112-BL-A	38	1SNG610037R0000	EP-DOP-SZ18-LGR-B	35	1SNG613002R0000	EM-EMC2-M12-MET-B	18
1SNG609026R0000	ECR-WG-NPT2-BL-A	38	1SNG610038R0000	EP-DOP-SZ18-GR-B	35	1SNG613003R0000	EM-EMC2-M16-MET-A	18
1SNG609027R0000	ENBR-WG-NPT14-BL-A	38	1SNG610039R0000	EP-DOP-SZ18-BL-B	35	1SNG613004R0000	EM-EMC2-M16-MET-B	18
1SNG609028R0000	ENBR-WG-NPT38-BL-A	38	1SNG610040R0000	EP-DOP-SZ20-LGR-A	35	1SNG613005R0000	EM-EMC2-M16-MET-C	18
1SNG609029R0000	ENBR-WG-NPT12-BL-A	38	1SNG610041R0000	EP-DOP-SZ20-GR-A	35	1SNG613006R0000	EM-EMC2-M20-MET-A	18
1SNG609030R0000	ENBR-WG-NPT34-BL-A	38	1SNG610043R0000	EP-DOP-SZ20-BL-A	35	1SNG613007R0000	EM-EMC2-M20-MET-B	18
1SNG609031R0000	ENBR-WG-NPT1-BL-A	38	1SNG610043R0000	EP-DOP-SZ20-LGR-B	35	1SNG613008R0000	EM-EMC2-M25-MET-A	18
1SNG609032R0000	ENBR-WG-NPT114-BL-A	38	1SNG610044R0000	EP-DOP-SZ20-GR-B	35	1SNG613009R0000	EM-EMC2-M25-MET-B	18
1SNG609033R0000	ENBR-WG-NPT112-BL-A	38	1SNG610045R0000	EP-DOP-SZ20-BL-B	35	1SNG613010R0000	EM-EMC2-M25-MET-C	18
1SNG609034R0000	ENBR-WG-NPT2-BL-A	38	1SNG610046R0000	EP-DOP-SZ22-LGR-A	35	1SNG613011R0000	EM-EMC2-M32-MET-A	18
1SNG609035R0000	ECR-WG-PG7-BL-A	38	1SNG610047R0000	EP-DOP-SZ22-GR-A	35	1SNG613012R0000	EM-EMC2-M32-MET-B	18
1SNG609036R0000	ECR-WG-PG9-BL-A	38	1SNG610048R0000	EP-DOP-SZ22-BL-A	35	1SNG613013R0000	EM-EMC2-M32-MET-C	18
1SNG609037R0000	ECR-WG-PG11-BL-A	38	1SNG610049R0000	EP-DOP-SZ22-LGR-B	35	1SNG613014R0000	EM-EMC2-M32-MET-A	18
1SNG609038R0000	ECR-WG-PG135-BL-A	38	1SNG610050R0000	EP-DOP-SZ22-GR-B	35	1SNG613015R0000	EM-EMC2-M40-MET-B	18
1SNG609039R0000	ECR-WG-PG16-BL-A	38	1SNG610051R0000	EP-DOP-SZ22-BL-B	35	1SNG613016R0000	EM-EMC2-M40-MET-C	18
1SNG609040R0000	ECR-WG-PG21-BL-A	38	1SNG610052R0000	EP-DOP-SZ24-LGR-A	35	1SNG613017R0000	EM-EMC2-M50-MET-A	18
1SNG609041R0000	ECR-WG-PG29-BL-A	38	1SNG610053R0000	EP-DOP-SZ24-GR-A	35	1SNG613018R0000	EM-EMC2-M50-MET-B	18
1SNG609042R0000	ECR-WG-PG36-BL-A	38	1SNG610054R0000	EP-DOP-SZ24-BL-A	35	1SNG613019R0000	EM-EMC2-M63-MET-A	18
1SNG609043R0000	ECR-WG-PG42-BL-A	38	1SNG610055R0000	EP-DOP-SZ24-LGR-B	35	1SNG613020R0000	EM-EMC2-M63-MET-B	18
1SNG609044R0000	ECR-WG-PG48-BL-A	38	1SNG610056R0000	EP-DOP-SZ24-GR-B	35	1SNG613021R0000	EM-EMC2-NPT38-MET-A	18
1SNG609045R0000	ENBR-WG-PG7-BL-A	38	1SNG610057R0000	EP-DOP-SZ24-BL-B	35	1SNG613022R0000	EM-EMC2-NPT12-MET-A	18
1SNG609046R0000	ENBR-WG-PG9-BL-A	38	1SNG610058R0000	EP-DOP-SZ29-LGR-A	35	1SNG613023R0000	EM-EMC2-NPT34-MET-A	18
1SNG609047R0000	ENBR-WG-PG11-BL-A	38	1SNG610059R0000	EP-DOP-SZ29-GR-A	35	1SNG613024R0000	EM-EMC2-NPT1-MET-A	18
1SNG609048R0000	ENBR-WG-PG135-BL-A	38	1SNG610060R0000	EP-DOP-SZ29-BL-A	35	1SNG613025R0000	EM-EMC2-PG7-MET-A	19
1SNG609049R0000	ENBR-WG-PG16-BL-A	38	1SNG610061R0000	EP-DOP-SZ29-LGR-B	35	1SNG613026R0000	EM-EMC2-PG7-MET-B	19
1SNG609050R0000	ENBR-WG-PG21-BL-A	38	1SNG610062R0000	EP-DOP-SZ29-GR-B	35	1SNG613027R0000	EM-EMC2-PG9-MET-A	19
1SNG609051R0000	ENBR-WG-PG29-BL-A	38	1SNG610063R0000	EP-DOP-SZ29-BL-B	35	1SNG613028R0000	EM-EMC2-PG9-MET-B	19
1SNG609052R0000	ENBR-WG-PG36-BL-A	38	1SNG610064R0000	EP-DOP-SZ32-LGR-A	35	1SNG613029R0000	EM-EMC2-PG11-MET-A	19
1SNG609053R0000	ENBR-WG-PG42-BL-A	38	1SNG610065R0000	EP-DOP-SZ32-GR-A	35	1SNG613030R0000	EM-EMC2-PG11-MET-B	19
1SNG609054R0000	ENBR-WG-PG48-BL-A	38	1SNG610066R0000	EP-DOP-SZ32-BL-A	35	1SNG613031R0000	EM-EMC2-PG135-MET-A	19
1SNG610001R0000	EP-DOP-SZ9-LGR-A	35	1SNG610067R0000	EP-DOP-SZ32-LGR-B	35	1SNG613032R0000	EM-EMC2-PG135-MET-B	19
1SNG610002R0000	EP-DOP-SZ9-GR-A	35	1SNG610068R0000	EP-DOP-SZ32-GR-B	35	1SNG613033R0000	EM-EMC2-PG16-MET-A	19
1SNG610003R0000	EP-DOP-SZ9-BL-A	35	1SNG610069R0000	EP-DOP-SZ32-BL-B	35	1SNG613034R0000	EM-EMC2-PG16-MET-B	19
1SNG610004R0000	EP-DOP-SZ9-LGR-B	35	1SNG610070R0000	EP-DOP-SZ37-LGR-A	35	1SNG613035R0000	EM-EMC2-PG21-MET-A	19
1SNG610005R0000	EP-DOP-SZ9-GR-B	35	1SNG610071R0000	EP-DOP-SZ37-GR-A	35	1SNG613036R0000	EM-EMC2-PG21-MET-B	19
1SNG610006R0000	EP-DOP-SZ9-BL-B	35	1SNG610072R0000	EP-DOP-SZ37-BL-A	35	1SNG613037R0000	EM-EMC2-PG29-MET-A	19
1SNG610007R0000	EP-DOP-SZ11-LGR-A	35	1SNG610073R0000	EP-DOP-SZ37-LGR-B	35	1SNG613038R0000	EM-EMC2-PG29-MET-B	19
1SNG610008R0000	EP-DOP-SZ11-GR-A	35	1SNG610074R0000	EP-DOP-SZ37-GR-B	35	1SNG613039R0000	EM-EMC2-PG36-MET-A	19
1SNG610009R0000	EP-DOP-SZ11-BL-A	35	1SNG610075R0000	EP-DOP-SZ37-BL-B	35	1SNG613040R0000	EM-EMC2-PG36-MET-B	19

# Index

## Part Number Classification

Part Number	Type	Page	Part Number	Type	Page	Part Number	Type	Page
1SNG613041R0000	EM-EMC2-PG42-MET-A	19	1SNG618002R0000	EP-RJG-M20-GR-A	16	1SNG620027R0000	EP-ROP-M25-BL-C	32
1SNG613042R0000	EM-EMC2-PG42-MET-B	19	1SNG618003R0000	EP-RJG-M20-BL-A	16	1SNG620028R0000	EP-ROP-M32-LGR-A	32
1SNG613043R0000	EM-EMC2-PG48-MET-A	19	1SNG618004R0000	EP-RJG-M20-LGR-B	16	1SNG620029R0000	EP-ROP-M32-GR-A	32
1SNG613044R0000	EM-EMC2-PG48-MET-B	19	1SNG618005R0000	EP-RJG-M20-GR-B	16	1SNG620030R0000	EP-ROP-M32-BL-A	32
1SNG614001R0000	EM-EMC4-M12-MET-A	20	1SNG618006R0000	EP-RJG-M20-BL-B	16	1SNG620031R0000	EP-ROP-M32-LGR-B	32
1SNG614002R0000	EM-EMC4-M16-MET-A	20	1SNG618007R0000	EP-RJG-M25-LGR-A	16	1SNG620032R0000	EP-ROP-M32-GR-B	32
1SNG614003R0000	EM-EMC4-M20-MET-A	20	1SNG618008R0000	EP-RJG-M25-GR-A	16	1SNG620033R0000	EP-ROP-M32-BL-B	32
1SNG614004R0000	EM-EMC4-M20-MET-B	20	1SNG618009R0000	EP-RJG-M25-BL-A	16	1SNG620034R0000	EP-ROP-M40-LGR-A	32
1SNG614005R0000	EM-EMC4-M25-MET-A	20	1SNG618010R0000	EP-RJG-M25-LGR-B	16	1SNG620035R0000	EP-ROP-M40-GR-A	32
1SNG614006R0000	EM-EMC4-M32-MET-A	20	1SNG618011R0000	EP-RJG-M25-GR-B	16	1SNG620036R0000	EP-ROP-M40-BL-A	32
1SNG614007R0000	EM-EMC4-M40-MET-A	20	1SNG618012R0000	EP-RJG-M25-BL-B	16	1SNG620037R0000	EP-ROP-M40-LGR-B	32
1SNG614008R0000	EM-EMC4-M50-MET-A	20	1SNG618013R0000	EP-RJG-M25-LGR-C	16	1SNG620038R0000	EP-ROP-M40-GR-B	32
1SNG614009R0000	EM-EMC4-M63-MET-A	20	1SNG618014R0000	EP-RJG-M25-GR-C	16	1SNG620039R0000	EP-ROP-M40-BL-B	32
1SNG614010R0000	EM-EMC4-M63-MET-B	20	1SNG618015R0000	EP-RJG-M25-BL-C	16	1SNG620040R0000	EP-ROP-M50-LGR-A	32
1SNG614011R0000	EM-EMC4-NPT14-MET-A	20	1SNG618016R0000	EP-RJG-M25-LGR-D	16	1SNG620041R0000	EP-ROP-M50-GR-A	32
1SNG614012R0000	EM-EMC4-NPT38-MET-A	20	1SNG618017R0000	EP-RJG-M25-GR-D	16	1SNG620042R0000	EP-ROP-M50-BL-A	32
1SNG614013R0000	EM-EMC4-NPT12-MET-A	20	1SNG618018R0000	EP-RJG-M25-BL-D	16	1SNG620043R0000	EP-ROP-PG7-LGR-A	32
1SNG614014R0000	EM-EMC4-NPT12-MET-B	20	1SNG618019R0000	EP-RJG-PG16-LGR-A	16	1SNG620044R0000	EP-ROP-PG7-GR-A	32
1SNG614015R0000	EM-EMC4-NPT34-MET-A	20	1SNG618020R0000	EP-RJG-PG16-GR-A	16	1SNG620045R0000	EP-ROP-PG7-BL-A	32
1SNG614016R0000	EM-EMC4-NPT1-MET-A	20	1SNG618021R0000	EP-RJG-PG16-BL-A	16	1SNG620046R0000	EP-ROP-PG7-LGR-B	32
1SNG614017R0000	EM-EMC4-NPT114-MET-A	20	1SNG618022R0000	EP-RJG-PG16-LGR-B	16	1SNG620047R0000	EP-ROP-PG7-GR-B	32
1SNG614018R0000	EM-EMC4-NPT112-MET-A	20	1SNG618023R0000	EP-RJG-PG16-GR-B	16	1SNG620048R0000	EP-ROP-PG7-BL-B	32
1SNG614019R0000	EM-EMC4-NPT2-MET-A	20	1SNG618024R0000	EP-RJG-PG16-BL-B	16	1SNG620049R0000	EP-ROP-PG9-LGR-A	32
1SNG614020R0000	EM-EMC4-PG7-MET-A	20	1SNG619001R0000	EM-RJG-M20-MET-A	17	1SNG620050R0000	EP-ROP-PG9-GR-A	32
1SNG614021R0000	EM-EMC4-PG9-MET-A	20	1SNG619002R0000	EM-RJG-M20-MET-B	17	1SNG620051R0000	EP-ROP-PG9-BL-A	32
1SNG614022R0000	EM-EMC4-PG11-MET-A	20	1SNG619003R0000	EM-RJG-M20-MET-C	17	1SNG620052R0000	EP-ROP-PG9-LGR-B	32
1SNG614023R0000	EM-EMC4-PG135-MET-A	20	1SNG619004R0000	EM-RJG-M20-MET-D	17	1SNG620053R0000	EP-ROP-PG9-GR-B	32
1SNG614024R0000	EM-EMC4-PG16-MET-A	20	1SNG619005R0000	EM-RJG-M25-MET-A	17	1SNG620054R0000	EP-ROP-PG9-BL-B	32
1SNG614025R0000	EM-EMC4-PG21-MET-A	20	1SNG619006R0000	EM-RJG-M25-MET-B	17	1SNG620055R0000	EP-ROP-PG11-LGR-A	32
1SNG614026R0000	EM-EMC4-PG29-MET-A	20	1SNG619007R0000	EM-RJG-M25-MET-C	17	1SNG620056R0000	EP-ROP-PG11-GR-A	32
1SNG614027R0000	EM-EMC4-PG36-MET-A	20	1SNG619008R0000	EM-RJG-M25-MET-D	17	1SNG620057R0000	EP-ROP-PG11-BL-A	32
1SNG614028R0000	EM-EMC4-PG42-MET-A	20	1SNG619009R0000	EM-RJG-M25-MET-E	17	1SNG620058R0000	EP-ROP-PG11-LGR-B	32
1SNG614029R0000	EM-EMC4-PG48-MET-A	20	1SNG619010R0000	EM-RJG-M32-MET-A	17	1SNG620059R0000	EP-ROP-PG11-GR-B	32
1SNG615001R0000	EM-HG-M12-MET-A	22	1SNG619011R0000	EM-RJG-M40-MET-A	17	1SNG620060R0000	EP-ROP-PG11-BL-B	32
1SNG615002R0000	EM-HG-M16-MET-A	22	1SNG619012R0000	EM-RJG-M40-MET-B	17	1SNG620061R0000	EP-ROP-PG135-LGR-A	32
1SNG615003R0000	EM-HG-M20-MET-A	22	1SNG619013R0000	EM-RJG-PG135-MET-A	17	1SNG620062R0000	EP-ROP-PG135-GR-A	32
1SNG615004R0000	EM-HG-M25-MET-A	22	1SNG619014R0000	EM-RJG-PG16-MET-A	17	1SNG620063R0000	EP-ROP-PG135-BL-A	32
1SNG615005R0000	EM-HG-NPT14-MET-A	22	1SNG619015R0000	EM-RJG-PG16-MET-B	17	1SNG620064R0000	EP-ROP-PG135-LGR-B	32
1SNG615006R0000	EM-HG-NPT38-MET-A	22	1SNG619016R0000	EM-RJG-PG21-MET-A	17	1SNG620065R0000	EP-ROP-PG135-GR-B	32
1SNG615007R0000	EM-HG-NPT34-MET-A	22	1SNG619017R0000	EM-RJG-PG21-MET-B	17	1SNG620066R0000	EP-ROP-PG135-BL-B	32
1SNG615008R0000	EM-HG-NPT34-MET-A	22	1SNG620001R0000	EP-ROP-M12-LGR-A	32	1SNG620067R0000	EP-ROP-PG16-LGR-A	32
1SNG615009R0000	EM-HG-SZ1-MET-A	22	1SNG620002R0000	EP-ROP-M12-GR-A	32	1SNG620068R0000	EP-ROP-PG16-GR-A	32
1SNG615010R0000	EM-HG-SZ2-MET-A	22, 23	1SNG620003R0000	EP-ROP-M12-BL-A	32	1SNG620069R0000	EP-ROP-PG16-BL-A	32
1SNG615011R0000	EM-HG-SZ3-MET-A	22, 23	1SNG620004R0000	EP-ROP-M12-LGR-B	32	1SNG620070R0000	EP-ROP-PG16-LGR-B	32
1SNG615012R0000	EM-HG-SZ4-MET-A	22, 23	1SNG620005R0000	EP-ROP-M12-GR-B	32	1SNG620071R0000	EP-ROP-PG16-GR-B	32
1SNG616001R0000	EM-HCF-M16-MET-A	24	1SNG620006R0000	EP-ROP-M12-BL-B	32	1SNG620072R0000	EP-ROP-PG16-BL-B	32
1SNG616002R0000	EM-HCF-M20-MET-A	24	1SNG620007R0000	EP-ROP-M16-LGR-A	32	1SNG620073R0000	EP-ROP-PG21-LGR-A	32
1SNG616003R0000	EM-HCF-M25-MET-A	24	1SNG620008R0000	EP-ROP-M16-GR-A	32	1SNG620074R0000	EP-ROP-PG21-GR-A	32
1SNG616004R0000	EM-HCF-M32-MET-A	24	1SNG620009R0000	EP-ROP-M16-BL-A	32	1SNG620075R0000	EP-ROP-PG21-BL-A	32
1SNG616005R0000	EM-HCF-M40-MET-A	24	1SNG620010R0000	EP-ROP-M16-LGR-B	32	1SNG620076R0000	EP-ROP-PG21-LGR-B	32
1SNG616006R0000	EM-HCF-M50-MET-A	24	1SNG620011R0000	EP-ROP-M16-GR-B	32	1SNG620077R0000	EP-ROP-PG21-GR-B	32
1SNG616007R0000	EM-HCF-M63-MET-A	24	1SNG620012R0000	EP-ROP-M16-BL-B	32	1SNG620078R0000	EP-ROP-PG21-BL-B	32
1SNG616008R0000	EM-HCF-NPT38-MET-A	24	1SNG620013R0000	EP-ROP-M20-LGR-A	32	1SNG620079R0000	EP-ROP-PG29-LGR-A	32
1SNG616009R0000	EM-HCF-NPT12-MET-A	24	1SNG620014R0000	EP-ROP-M20-GR-A	32	1SNG620080R0000	EP-ROP-PG29-GR-A	32
1SNG616010R0000	EM-HCF-NPT34-MET-A	24	1SNG620015R0000	EP-ROP-M20-BL-A	32	1SNG620081R0000	EP-ROP-PG29-BL-A	32
1SNG616011R0000	EM-HCF-NPT1-MET-A	24	1SNG620016R0000	EP-ROP-M20-LGR-B	32	1SNG620082R0000	EP-ROP-PG29-LGR-B	32
1SNG616012R0000	EM-HCF-NPT114-MET-A	24	1SNG620017R0000	EP-ROP-M20-GR-B	32	1SNG620083R0000	EP-ROP-PG29-GR-B	32
1SNG616013R0000	EM-HCF-NPT112-MET-A	24	1SNG620018R0000	EP-ROP-M20-BL-B	32	1SNG620084R0000	EP-ROP-PG29-BL-B	32
1SNG616014R0000	EM-HCF-NPT2-MET-A	24	1SNG620019R0000	EP-ROP-M25-LGR-A	32	1SNG620085R0000	EP-ROP-PG36-LGR-A	32
1SNG617001R0000	EM-HEMC-M16-MET-A	23	1SNG620020R0000	EP-ROP-M25-GR-A	32	1SNG620086R0000	EP-ROP-PG36-GR-A	32
1SNG617002R0000	EM-HEMC-M20-MET-A	23	1SNG620021R0000	EP-ROP-M25-BL-A	32	1SNG620087R0000	EP-ROP-PG36-BL-A	32
1SNG617003R0000	EM-HEMC-M25-MET-A	23	1SNG620022R0000	EP-ROP-M25-LGR-B	32	1SNG621001R0000	EM-ROP-M12-MET-A	33
1SNG617004R0000	EM-HEMC-NPT38-MET-A	23	1SNG620023R0000	EP-ROP-M25-GR-B	32	1SNG621002R0000	EM-ROP-M16-MET-A	33
1SNG617005R0000	EM-HEMC-NPT12-MET-A	23	1SNG620024R0000	EP-ROP-M25-BL-B	32	1SNG621003R0000	EM-ROP-M20-MET-A	33
1SNG617006R0000	EM-HEMC-NPT34-MET-A	23	1SNG620025R0000	EP-ROP-M25-LGR-C	32	1SNG621004R0000	EM-ROP-M25-MET-A	33
1SNG618001R0000	EP-RJG-M20-LGR-A	16	1SNG620026R0000	EP-ROP-M25-GR-C	32	1SNG621005R0000	EM-ROP-M32-MET-A	33

# Index

## Part Number Classification

Part Number	Type	Page	Part Number	Type	Page	Part Number	Type	Page
1SNG621006R0000	EM-ROP-M40-MET-A	33	1SNG624003R0000	EM-VEP-M1210-MET-C	30	1SNG625037R0000	EM-SGL-M40-MET-A	12
1SNG621007R0000	EM-ROP-M50-MET-A	33	1SNG624004R0000	EM-VEP-M1210-MET-D	30	1SNG625038R0000	EM-SGL-M40-MET-B	12
1SNG621008R0000	EM-ROP-M63-MET-A	33	1SNG624005R0000	EM-VEP-M12-MET-A	30	1SNG625039R0000	EM-SGL-M40-MET-C	12
1SNG621009R0000	EM-ROP-PG7-MET-A	33	1SNG624006R0000	EM-VEP-M12-MET-B	30	1SNG625040R0000	EM-SGL-M40-MET-D	12
1SNG621010R0000	EM-ROP-PG9-MET-A	33	1SNG624007R0000	EM-VEP-M12-MET-C	30	1SNG625041R0000	EM-SGL-M40-MET-E	12
1SNG621011R0000	EM-ROP-PG11-MET-A	33	1SNG624008R0000	EM-VEP-M12-MET-D	30	1SNG625042R0000	EM-SGL-M40-MET-F	12
1SNG621012R0000	EM-ROP-PG135-MET-A	33	1SNG624009R0000	EM-VEP-M12-MET-E	30	1SNG625043R0000	EM-SGL-M40-MET-G	12
1SNG621013R0000	EM-ROP-PG16-MET-A	33	1SNG624010R0000	EM-VEP-M12-MET-F	30	1SNG625044R0000	EM-SGL-M40-MET-H	12
1SNG621014R0000	EM-ROP-PG21-MET-A	33	1SNG624011R0000	EM-VEP-M12-MET-G	30	1SNG625045R0000	EM-SGL-M40-MET-I	12
1SNG621015R0000	EM-ROP-PG29-MET-A	33	1SNG624012R0000	EM-VEP-M12-MET-H	30	1SNG625046R0000	EM-SGL-M40-MET-J	12
1SNG621016R0000	EM-ROP-PG36-MET-A	33	1SNG624013R0000	EM-VEP-M16-MET-A	30	1SNG625047R0000	EM-SGL-NPT12-MET-A	13
1SNG621017R0000	EM-ROP-PG42-MET-A	33	1SNG624014R0000	EM-VEP-M16-MET-B	30	1SNG625048R0000	EM-SGL-NPT12-MET-B	13
1SNG621018R0000	EM-ROP-PG48-MET-A	33	1SNG624015R0000	EM-VEP-M16-MET-C	30	1SNG625049R0000	EM-SGL-NPT12-MET-C	13
1SNG622001R0000	EP-SIG-SZ16-LGR-A	14	1SNG624016R0000	EM-VEP-M16-MET-D	30	1SNG625050R0000	EM-SGL-NPT12-MET-D	13
1SNG622002R0000	EP-SIG-SZ16-GR-A	14	1SNG624017R0000	EM-VEP-M16-MET-E	30	1SNG625051R0000	EM-SGL-NPT34-MET-A	13
1SNG622003R0000	EP-SIG-SZ16-BL-A	14	1SNG624018R0000	EM-VEP-M16-MET-F	30	1SNG625052R0000	EM-SGL-NPT34-MET-B	13
1SNG622004R0000	EP-SIG-SZ16-LGR-B	14	1SNG624019R0000	EM-VEP-M16-MET-G	30	1SNG625053R0000	EM-SGL-NPT1-MET-A	13
1SNG622005R0000	EP-SIG-SZ16-GR-B	14	1SNG624020R0000	EM-VEP-M16-MET-H	30	1SNG625054R0000	EM-SGL-NPT1-MET-B	13
1SNG622006R0000	EP-SIG-SZ16-BL-B	14	1SNG624021R0000	EM-VEP-M20-MET-A	30	1SNG625055R0000	EM-SGL-NPT114-MET-A	13
1SNG622007R0000	EP-SIG-SZ20-LGR-A	14	1SNG624022R0000	EM-VEP-M20-MET-B	30	1SNG625056R0000	EM-SGL-NPT112-MET-A	13
1SNG622008R0000	EP-SIG-SZ20-GR-A	14	1SNG624023R0000	EM-VEP-M20-MET-C	30	1SNG625057R0000	EM-SGL-NPT2-MET-A	13
1SNG622009R0000	EP-SIG-SZ20-BL-A	14	1SNG624024R0000	EM-VEP-M20-MET-D	30	1SNG625058R0000	EM-SGL-PG9-MET-A	13
1SNG622010R0000	EP-SIG-SZ20-LGR-B	14	1SNG624025R0000	EM-VEP-M20-MET-E	30	1SNG625059R0000	EM-SGL-PG9-MET-B	13
1SNG622011R0000	EP-SIG-SZ20-GR-B	14	1SNG624026R0000	EM-VEP-M20-MET-F	30	1SNG625060R0000	EM-SGL-PG9-MET-C	13
1SNG622012R0000	EP-SIG-SZ20-BL-B	14	1SNG624027R0000	EM-VEP-M20-MET-G	30	1SNG625061R0000	EM-SGL-PG9-MET-D	13
1SNG622013R0000	EP-SIG-SZ20-LGR-C	14	1SNG624028R0000	EM-VEP-M40-MET-H	30	1SNG625062R0000	EM-SGL-PG11-MET-A	13
1SNG622014R0000	EP-SIG-SZ20-GR-C	14	1SNG624029R0000	EM-VEP-M40-MET-A	30	1SNG625063R0000	EM-SGL-PG11-MET-B	13
1SNG622015R0000	EP-SIG-SZ20-BL-C	14	1SNG624030R0000	EM-VEP-M40-MET-B	30	1SNG625064R0000	EM-SGL-PG11-MET-C	13
1SNG622016R0000	EP-SIG-SZ20-LGR-D	14	1SNG624031R0000	EM-VEP-M40-MET-C	30	1SNG625065R0000	EM-SGL-PG11-MET-D	13
1SNG622017R0000	EP-SIG-SZ20-GR-D	14	1SNG624032R0000	EM-VEP-M40-MET-D	30	1SNG625066R0000	EM-SGL-PG135-MET-A	13
1SNG622018R0000	EP-SIG-SZ20-BL-D	14	1SNG625001R0000	EM-SGL-M16-MET-A	12	1SNG625067R0000	EM-SGL-PG135-MET-B	13
1SNG622019R0000	EP-SIG-SZ25-LGR-A	14	1SNG625002R0000	EM-SGL-M16-MET-B	12	1SNG625068R0000	EM-SGL-PG135-MET-C	13
1SNG622020R0000	EP-SIG-SZ25-GR-A	14	1SNG625003R0000	EM-SGL-M16-MET-C	12	1SNG625069R0000	EM-SGL-PG135-MET-D	13
1SNG622021R0000	EP-SIG-SZ25-BL-A	14	1SNG625004R0000	EM-SGL-M16-MET-D	12	1SNG625070R0000	EM-SGL-PG16-MET-A	13
1SNG622022R0000	EP-SIG-SZ25-LGR-B	14	1SNG625005R0000	EM-SGL-M16-MET-E	12	1SNG625071R0000	EM-SGL-PG16-MET-B	13
1SNG622023R0000	EP-SIG-SZ25-GR-B	14	1SNG625006R0000	EM-SGL-M16-MET-F	12	1SNG625072R0000	EM-SGL-PG16-MET-C	13
1SNG622024R0000	EP-SIG-SZ25-BL-B	14	1SNG625007R0000	EM-SGL-M16-MET-G	12	1SNG625073R0000	EM-SGL-PG16-MET-D	13
1SNG622025R0000	EP-SIG-SZ32-LGR-A	14	1SNG625008R0000	EM-SGL-M16-MET-H	12	1SNG625074R0000	EM-SGL-PG21-MET-A	13
1SNG622026R0000	EP-SIG-SZ32-GR-A	14	1SNG625009R0000	EM-SGL-M16-MET-I	12	1SNG625075R0000	EM-SGL-PG21-MET-B	13
1SNG622027R0000	EP-SIG-SZ32-BL-A	14	1SNG625010R0000	EM-SGL-M20-MET-A	12	1SNG625076R0000	EM-SGL-PG21-MET-C	13
1SNG622028R0000	EP-SIG-SZ32-LGR-B	14	1SNG625011R0000	EM-SGL-M20-MET-B	12	1SNG625077R0000	EM-SGL-PG21-MET-D	13
1SNG622029R0000	EP-SIG-SZ32-GR-B	14	1SNG625012R0000	EM-SGL-M20-MET-C	12	1SNG625078R0000	EM-SGL-PG29-MET-A	13
1SNG622030R0000	EP-SIG-SZ32-BL-B	14	1SNG625013R0000	EM-SGL-M20-MET-D	12	1SNG625079R0000	EM-SGL-PG29-MET-B	13
1SNG622031R0000	EP-SIG-SZ40-LGR-A	14	1SNG625014R0000	EM-SGL-M20-MET-E	12	1SNG625080R0000	EM-SGL-PG29-MET-C	13
1SNG622032R0000	EP-SIG-SZ40-GR-A	14	1SNG625015R0000	EM-SGL-M20-MET-F	12	1SNG625081R0000	EM-SGL-PG29-MET-D	13
1SNG622033R0000	EP-SIG-SZ40-BL-A	14	1SNG625016R0000	EM-SGL-M20-MET-G	12	1SNG626001R0000	EP-SGL-M16-LGR-A	8
1SNG622034R0000	EP-SIG-SZ40-LGR-B	14	1SNG625017R0000	EM-SGL-M25-MET-A	12	1SNG626002R0000	EP-SGL-M16-GR-A	8
1SNG622035R0000	EP-SIG-SZ40-GR-B	14	1SNG625018R0000	EM-SGL-M25-MET-B	12	1SNG626003R0000	EP-SGL-M16-BL-A	8
1SNG622036R0000	EP-SIG-SZ40-BL-B	14	1SNG625019R0000	EM-SGL-M25-MET-C	12	1SNG626004R0000	EP-SGL-M16-LGR-B	8
1SNG623001R0000	EM-SIG-SZ16-MET-A	15	1SNG625020R0000	EM-SGL-M25-MET-D	12	1SNG626005R0000	EP-SGL-M16-GR-B	8
1SNG623002R0000	EM-SIG-SZ16-MET-B	15	1SNG625021R0000	EM-SGL-M25-MET-E	12	1SNG626006R0000	EP-SGL-M16-BL-B	8
1SNG623003R0000	EM-SIG-SZ16-MET-C	15	1SNG625022R0000	EM-SGL-M25-MET-F	12	1SNG626007R0000	EP-SGL-M16-LGR-C	8
1SNG623004R0000	EM-SIG-SZ20-MET-A	15	1SNG625023R0000	EM-SGL-M25-MET-G	12	1SNG626008R0000	EP-SGL-M16-GR-C	8
1SNG623005R0000	EM-SIG-SZ20-MET-B	15	1SNG625024R0000	EM-SGL-M25-MET-H	12	1SNG626009R0000	EP-SGL-M16-BL-C	8
1SNG623006R0000	EM-SIG-SZ20-MET-C	15	1SNG625025R0000	EM-SGL-M25-MET-I	12	1SNG626010R0000	EP-SGL-M16-LGR-D	8
1SNG623007R0000	EM-SIG-SZ25-MET-A	15	1SNG625026R0000	EM-SGL-M25-MET-J	12	1SNG626011R0000	EP-SGL-M16-GR-D	8
1SNG623008R0000	EM-SIG-SZ25-MET-B	15	1SNG625027R0000	EM-SGL-M32-MET-A	12	1SNG626012R0000	EP-SGL-M16-BL-D	8
1SNG623009R0000	EM-SIG-SZ25-MET-C	15	1SNG625028R0000	EM-SGL-M32-MET-B	12	1SNG626013R0000	EP-SGL-M16-LGR-E	8
1SNG623010R0000	EM-SIG-SZ32-MET-A	15	1SNG625029R0000	EM-SGL-M32-MET-C	12	1SNG626014R0000	EP-SGL-M16-GR-E	8
1SNG623011R0000	EM-SIG-SZ32-MET-B	15	1SNG625030R0000	EM-SGL-M32-MET-D	12	1SNG626015R0000	EP-SGL-M16-BL-E	8
1SNG623012R0000	EM-SIG-SZ32-MET-C	15	1SNG625031R0000	EM-SGL-M32-MET-E	12	1SNG626016R0000	EP-SGL-M16-LGR-F	8
1SNG623013R0000	EM-SIG-SZ40-MET-A	15	1SNG625032R0000	EM-SGL-M32-MET-F	12	1SNG626017R0000	EP-SGL-M16-GR-F	8
1SNG623014R0000	EM-SIG-SZ40-MET-B	15	1SNG625033R0000	EM-SGL-M32-MET-G	12	1SNG626018R0000	EP-SGL-M16-BL-F	8
1SNG623015R0000	EM-SIG-SZ40-MET-C	15	1SNG625034R0000	EM-SGL-M32-MET-H	12	1SNG626019R0000	EP-SGL-M16-LGR-G	8
1SNG624001R0000	EM-VEP-M1210-MET-A	30	1SNG625035R0000	EM-SGL-M32-MET-I	12	1SNG626020R0000	EP-SGL-M16-GR-G	8
1SNG624002R0000	EM-VEP-M1210-MET-B	30	1SNG625036R0000	EM-SGL-M32-MET-J	12	1SNG626021R0000	EP-SGL-M16-BL-G	8



# Index

## Part Number Classification

Part Number	Type	Page	Part Number	Type	Page	Part Number	Type	Page
1SNG626022R0000	EP-SGL-M16-LGR-H	8	1SNG626088R0000	EP-SGL-M32-LGR-C	8	1SNG626154R0000	EP-SGL-PG135-LGR-A	9
1SNG626023R0000	EP-SGL-M16-GR-H	8	1SNG626089R0000	EP-SGL-M32-GR-C	8	1SNG626155R0000	EP-SGL-PG135-GR-A	9
1SNG626024R0000	EP-SGL-M16-BL-H	8	1SNG626090R0000	EP-SGL-M32-BL-C	8	1SNG626156R0000	EP-SGL-PG135-BL-A	9
1SNG626025R0000	EP-SGL-M16-LGR-I	8	1SNG626091R0000	EP-SGL-M32-LGR-D	8	1SNG626157R0000	EP-SGL-PG135-LGR-B	9
1SNG626026R0000	EP-SGL-M16-GR-I	8	1SNG626092R0000	EP-SGL-M32-GR-D	8	1SNG626158R0000	EP-SGL-PG135-GR-B	9
1SNG626027R0000	EP-SGL-M16-BL-I	8	1SNG626093R0000	EP-SGL-M32-BL-D	8	1SNG626159R0000	EP-SGL-PG135-BL-B	9
1SNG626028R0000	EP-SGL-M16-LGR-J	8	1SNG626094R0000	EP-SGL-M32-LGR-E	8	1SNG626160R0000	EP-SGL-PG16-LGR-A	9
1SNG626029R0000	EP-SGL-M16-GR-J	8	1SNG626095R0000	EP-SGL-M32-GR-E	8	1SNG626161R0000	EP-SGL-PG16-GR-A	9
1SNG626030R0000	EP-SGL-M16-BL-J	8	1SNG626096R0000	EP-SGL-M32-BL-E	8	1SNG626162R0000	EP-SGL-PG16-BL-A	9
1SNG626031R0000	EP-SGL-M20-LGR-A	8	1SNG626097R0000	EP-SGL-M32-LGR-F	8	1SNG626163R0000	EP-SGL-PG16-LGR-B	9
1SNG626032R0000	EP-SGL-M20-GR-A	8	1SNG626098R0000	EP-SGL-M32-GR-F	8	1SNG626164R0000	EP-SGL-PG16-GR-B	9
1SNG626033R0000	EP-SGL-M20-BL-A	8	1SNG626099R0000	EP-SGL-M32-BL-F	8	1SNG626165R0000	EP-SGL-PG16-BL-B	9
1SNG626034R0000	EP-SGL-M20-LGR-B	8	1SNG626100R0000	EP-SGL-M40-LGR-A	8	1SNG626166R0000	EP-SGL-PG21-LGR-A	9
1SNG626035R0000	EP-SGL-M20-GR-B	8	1SNG626101R0000	EP-SGL-M40-GR-A	8	1SNG626167R0000	EP-SGL-PG21-GR-A	9
1SNG626036R0000	EP-SGL-M20-BL-B	8	1SNG626102R0000	EP-SGL-M40-BL-A	8	1SNG626168R0000	EP-SGL-PG21-BL-A	9
1SNG626037R0000	EP-SGL-M20-LGR-C	8	1SNG626103R0000	EP-SGL-M40-LGR-B	8	1SNG626169R0000	EP-SGL-PG21-LGR-B	9
1SNG626038R0000	EP-SGL-M20-GR-C	8	1SNG626104R0000	EP-SGL-M40-GR-B	8	1SNG626170R0000	EP-SGL-PG21-GR-B	9
1SNG626039R0000	EP-SGL-M20-BL-C	8	1SNG626105R0000	EP-SGL-M40-BL-B	8	1SNG626171R0000	EP-SGL-PG21-BL-B	9
1SNG626040R0000	EP-SGL-M20-LGR-D	8	1SNG626106R0000	EP-SGL-M40-LGR-C	8	1SNG626172R0000	EP-SGL-PG29-LGR-A	9
1SNG626041R0000	EP-SGL-M20-GR-D	8	1SNG626107R0000	EP-SGL-M40-GR-C	8	1SNG626173R0000	EP-SGL-PG29-GR-A	9
1SNG626042R0000	EP-SGL-M20-BL-D	8	1SNG626108R0000	EP-SGL-M40-BL-C	8	1SNG626174R0000	EP-SGL-PG29-BL-A	9
1SNG626043R0000	EP-SGL-M20-LGR-E	8	1SNG626109R0000	EP-SGL-M40-LGR-D	8	1SNG626175R0000	EP-SGL-PG29-LGR-B	9
1SNG626044R0000	EP-SGL-M20-GR-E	8	1SNG626110R0000	EP-SGL-M40-GR-D	8	1SNG626176R0000	EP-SGL-PG29-GR-B	9
1SNG626045R0000	EP-SGL-M20-BL-E	8	1SNG626111R0000	EP-SGL-M40-BL-D	8	1SNG626177R0000	EP-SGL-PG29-BL-B	9
1SNG626046R0000	EP-SGL-M20-LGR-F	8	1SNG626112R0000	EP-SGL-M40-LGR-E	8			
1SNG626047R0000	EP-SGL-M20-GR-F	8	1SNG626113R0000	EP-SGL-M40-GR-E	8			
1SNG626048R0000	EP-SGL-M20-BL-F	8	1SNG626114R0000	EP-SGL-M40-BL-E	8			
1SNG626049R0000	EP-SGL-M20-LGR-G	8	1SNG626115R0000	EP-SGL-M40-LGR-F	8			
1SNG626050R0000	EP-SGL-M20-GR-G	8	1SNG626116R0000	EP-SGL-M40-GR-F	8			
1SNG626051R0000	EP-SGL-M20-BL-G	8	1SNG626117R0000	EP-SGL-M40-BL-F	8			
1SNG626052R0000	EP-SGL-M20-LGR-H	8	1SNG626118R0000	EP-SGL-NPT12-LGR-A	9			
1SNG626053R0000	EP-SGL-M20-GR-H	8	1SNG626119R0000	EP-SGL-NPT12-GR-A	9			
1SNG626054R0000	EP-SGL-M20-BL-H	8	1SNG626120R0000	EP-SGL-NPT12-BL-A	9			
1SNG626055R0000	EP-SGL-M20-LGR-I	8	1SNG626121R0000	EP-SGL-NPT12-LGR-B	9			
1SNG626056R0000	EP-SGL-M20-GR-I	8	1SNG626122R0000	EP-SGL-NPT12-GR-B	9			
1SNG626057R0000	EP-SGL-M20-BL-I	8	1SNG626123R0000	EP-SGL-NPT12-BL-B	9			
1SNG626058R0000	EP-SGL-M25-LGR-A	8	1SNG626124R0000	EP-SGL-NPT12-LGR-C	9			
1SNG626059R0000	EP-SGL-M25-GR-A	8	1SNG626125R0000	EP-SGL-NPT12-GR-C	9			
1SNG626060R0000	EP-SGL-M25-BL-A	8	1SNG626126R0000	EP-SGL-NPT12-BL-C	9			
1SNG626061R0000	EP-SGL-M25-LGR-B	8	1SNG626127R0000	EP-SGL-NPT12-LGR-D	9			
1SNG626062R0000	EP-SGL-M25-GR-B	8	1SNG626128R0000	EP-SGL-NPT12-GR-D	9			
1SNG626063R0000	EP-SGL-M25-BL-B	8	1SNG626129R0000	EP-SGL-NPT12-BL-D	9			
1SNG626064R0000	EP-SGL-M25-LGR-C	8	1SNG626130R0000	EP-SGL-NPT34-LGR-A	9			
1SNG626065R0000	EP-SGL-M25-GR-C	8	1SNG626131R0000	EP-SGL-NPT34-GR-A	9			
1SNG626066R0000	EP-SGL-M25-BL-C	8	1SNG626132R0000	EP-SGL-NPT34-BL-A	9			
1SNG626067R0000	EP-SGL-M25-LGR-D	8	1SNG626133R0000	EP-SGL-NPT34-LGR-B	9			
1SNG626068R0000	EP-SGL-M25-GR-D	8	1SNG626134R0000	EP-SGL-NPT34-GR-B	9			
1SNG626069R0000	EP-SGL-M25-BL-D	8	1SNG626135R0000	EP-SGL-NPT34-BL-B	9			
1SNG626070R0000	EP-SGL-M25-LGR-E	8	1SNG626136R0000	EP-SGL-NPT1-LGR-A	9			
1SNG626071R0000	EP-SGL-M25-GR-E	8	1SNG626137R0000	EP-SGL-NPT1-GR-A	9			
1SNG626072R0000	EP-SGL-M25-BL-E	8	1SNG626138R0000	EP-SGL-NPT1-BL-A	9			
1SNG626073R0000	EP-SGL-M25-LGR-F	8	1SNG626139R0000	EP-SGL-NPT1-LGR-B	9			
1SNG626074R0000	EP-SGL-M25-GR-F	8	1SNG626140R0000	EP-SGL-NPT1-GR-B	9			
1SNG626075R0000	EP-SGL-M25-BL-F	8	1SNG626141R0000	EP-SGL-NPT1-BL-B	9			
1SNG626076R0000	EP-SGL-M25-LGR-G	8	1SNG626142R0000	EP-SGL-PG9-LGR-A	9			
1SNG626077R0000	EP-SGL-M25-GR-G	8	1SNG626143R0000	EP-SGL-PG9-GR-A	9			
1SNG626078R0000	EP-SGL-M25-BL-G	8	1SNG626144R0000	EP-SGL-PG9-BL-A	9			
1SNG626079R0000	EP-SGL-M25-LGR-H	8	1SNG626145R0000	EP-SGL-PG9-LGR-B	9			
1SNG626080R0000	EP-SGL-M25-GR-H	8	1SNG626146R0000	EP-SGL-PG9-GR-B	9			
1SNG626081R0000	EP-SGL-M25-BL-H	8	1SNG626147R0000	EP-SGL-PG9-BL-B	9			
1SNG626082R0000	EP-SGL-M32-LGR-A	8	1SNG626148R0000	EP-SGL-PG11-LGR-A	9			
1SNG626083R0000	EP-SGL-M32-GR-A	8	1SNG626149R0000	EP-SGL-PG11-GR-A	9			
1SNG626084R0000	EP-SGL-M32-BL-A	8	1SNG626150R0000	EP-SGL-PG11-BL-A	9			
1SNG626085R0000	EP-SGL-M32-LGR-B	8	1SNG626151R0000	EP-SGL-PG11-LGR-B	9			
1SNG626086R0000	EP-SGL-M32-GR-B	8	1SNG626152R0000	EP-SGL-PG11-GR-B	9			
1SNG626087R0000	EP-SGL-M32-BL-B	8	1SNG626153R0000	EP-SGL-PG11-BL-B	9			





---

**te.com**

© 2022 TE Connectivity Ltd. family of companies. All Rights Reserved.

ENTRELEC, TE Connectivity, TE connectivity (logo) and Every Connection Counts are trademarks. All other logos, products and/or company names referred to herein might be trademarks of their respective owners.

While TE has made every reasonable effort to ensure the accuracy of the information in this brochure, TE does not guarantee that it is error-free, nor does TE make any other representation, warranty or guarantee that the information is accurate, correct, reliable or current. TE reserves the right to make any changes to the information contained herein without prior notice. TE Connectivity assumes only those obligations set forth in the terms and conditions for this product and shall in no event be liable for any incidental, indirect, or consequential damages arising out of the sale, resale, use, or misapplication of the product. TE expressly disclaims any implied warranties with respect to the information contained herein, including, but not limited to, implied warranties of merchantability or fitness for a particular purpose. Dimensions, specifications and/or information contained herein are for reference purposes only and are subject to change without notice. Consult TE for the latest dimensions, specifications and/or information. Users of TE Connectivity products must make their own assessment as to whether the respective product is suitable for the respective desired application.

ENTRELEC / CABLE GLANDS / CATALOG / EN

04/22

---

**CATALOG**

TE Connectivity  
3, rue Jean Perrin  
69687 Chassieu cedex  
France  
Tel: +33 481923100

## X-ON Electronics

Largest Supplier of Electrical and Electronic Components

*Click to view similar products for [Enclosures, Boxes & Cases](#) category:*

*Click to view products by [TE Connectivity](#) manufacturer:*

Other Similar products are found below :

[M-10-PLATED](#) [60221-01](#) [M17-L-PLN](#) [M-21-PLATED](#) [63310-01-000](#) [6711GSKT](#) [90026-501-000](#) [PS36-200](#) [120-407](#) [138-PLAIN](#) [144011](#)  
[EAS-500 \(BLACK ANO\)](#) [2062750000](#) [KAB3421](#) [A0645271](#) [1928952](#) [2106-IR](#) [2792057](#) [2906241](#) [2906254](#) [2907981](#) [H5031](#) [CU-284](#)  
[MDC-532-PLAIN-ALUM](#) [B137](#) [5400TN](#) [UNC 2-4-6 PLAIN](#) [462-0020E](#) [0542100012](#) [043853](#) [103031](#) [11416P](#) [KR8-315](#) [UM-SE-A73-R](#)  
[BK](#) [2202158](#) [TUF 55 25 100 ME](#) [332-907](#) [4122](#) [52213](#) [24560-245](#) [736-409](#) [144012](#) [61-9480.6](#) [134573](#) [M18-L-PLTD](#) [73095-510-000](#)  
[CNM-0303 Black](#) [S3A-453213-S](#) [ALUG702RD040-IR](#) [07.6370000](#) [P/4.2](#)