

## EV250-1A & 1B 400 Amps CZONKA-II EVX Make & Break Load Switching

### Product Facts

- Hydrogen dielectric for power switching high current loads
- 400 A carry, 2,500 A interrupt @ 320 Vdc
- Suited for circuit protection, control, battery switching, and main power safety disconnect
- Versatile power, voltage, and current operating range: 28-1800 Vdc tested
- Low-cost compact version for volume production applications. Requires external coil economizer (PWM or lower hold voltage)
- “Hammer effect” mechanism breaks light contact welds
- “Super-sealed” environment chamber uniquely protects ALL moving parts
- Can operate in harsh environments
- Moving contact rotates to provide fresh contact surface for low contact resistance and low power consumption
- Sealed control connector. Mating connector with flying leads Part Number 2005 available, see page 7-95
- Logic control enabled by external economizer Part Number 9913
- High temperature (135°C) model with 10 inch flying leads available (-4A — Call TE for sales drawing)
- Bi-directional power switching
- Fast operate and release time

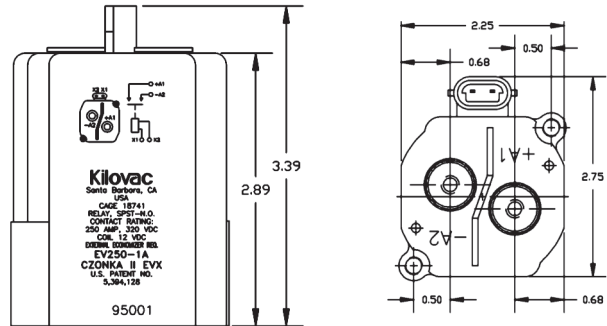

Note: Dimensions in inches. Multiply values by 25.4 for dimensions in mm.

### Product Specifications

**Contact Arrangement** — SPST-NO  
**Contact Form** — X  
**Continuous Current Carry, Max.** — 400 A; 6.5 Minutes — 500 A  
**Break Current @ 320 Vdc** — 2,500 A  
**Contact Resistance, Max.** — 0.0003 ohm  
**Contact Resistance, Typ.** — 0.0001 – 0.0002 ohm  
**Dielectric at Sea Level (Leakage < 1mA)** — 2,200 Vrms  
**Shock, 11ms, 1/2 Sine (Peak), Operating** — 30 g  
**Vibration, Sinusoidal (80-2000 Hz, Peak)** — 20 g  
**Operating Ambient Temperature Range** — -40°C to +85°C  
**Load Life** — See chart on next page  
**Operate Time, @ 25°C** —  
**Close (Includes Bounce), Typ.** — 30 ms  
**Bounce (After Close Only), Max.** — 5 ms  
**Open (Includes Arcing), Max.** — 15 ms  
**Insulation Resistance @ 500 Vdc, Min.** — 100 mohm  
**Weight, Nominal** — 1.54 lb (0.7 kg)

### Contact Ratings\*

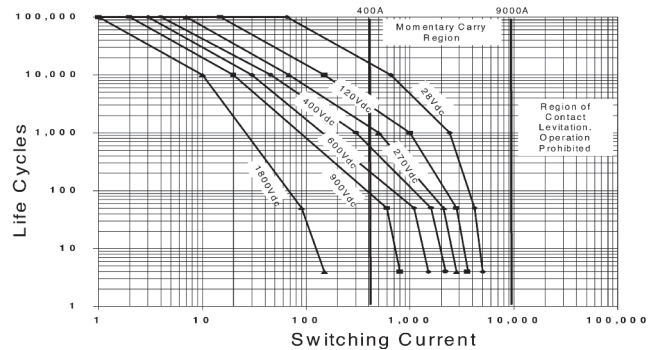

\*For circuit conditions and actual data refer to the EV250 hot switch study. Since each application is unique, user is encouraged to verify rating in actual application.

### Coil Data\*\*\*

	EV250-1A	EV250-1B
Voltage, Nominal*	12 Vdc	24 Vdc
Pickup (Close), Max.	8.3 Vdc	16.6 Vdc
Continuous Hold, Max./Min.**	5.1/3.8 Vdc	10.2/7.6 Vdc
Dropout (Open), Min.	0.88 - 3.3 Vdc	2.4 - 6.6 Vdc
Coil Resistance @ 25°C, ±10%	3 Ω	12 Ω
Coil Energy, Max.	0.2 J	0.2 J
Coil Clamping	3 x nom.	3 x nom.

\*Do not apply continuously. Requires external coil economizer. Other special coil voltages available upon request.

\*\*At maximum continuous current and maximum ambient temperature. Hold voltage must be maintained within the limits specified to keep contacts closed and to prevent coil overheating.

\*\*\*Do not use a free wheeling diode or capacitor across the coil.

### Ordering Information

Sample Part Number ►

EV250-1 A

Series: \_\_\_\_\_

Coil Voltage: \_\_\_\_\_

A = 12 Vdc, Nominal  
 B = 24 Vdc, Nominal

For factory-direct application assistance, dial 800-253-4560, ext. 2055, or 805-220-2055.

For detailed specifications and recommendations, refer to the EV250-1A & B sales drawings.

**EV250-1A & 1B 400 Amps CZONKA-II EVX Make & Break Load Switching** (Continued)

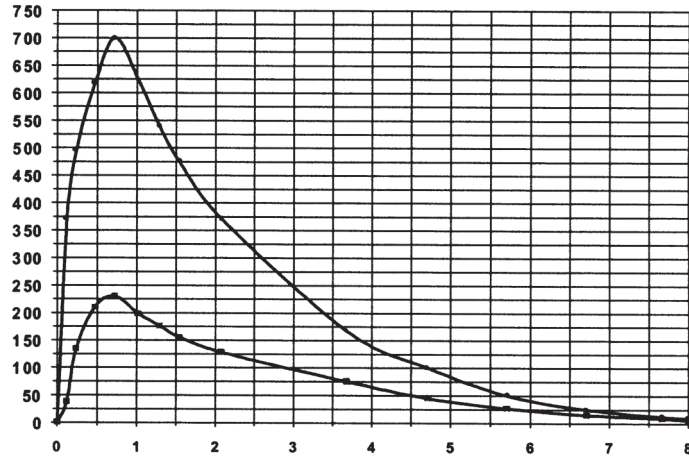
**Current vs Time**
**CONTACTS CLOSED INTO 70% AND 90% CAPACITOR PRE CHARGE**

**Life Ratings and Qualification Test Plan**

Test #	Normal Operations		Abnormal Operations	
	1	2	3	4
Current	Reference Graph and Test Circuit Diagram (Sht. 8)		-250 A	2500 A
Voltage			320 V	320 V
Load Type	Capacitive	Capacitive	Resistive	Resistive
% Pre Charge	90%	70%	NA	N/A
Switch Mode	Make Only	Make Only	Make/Break	Break Only
<b>Sequence</b>				
1	10K cycles	10 cycles	2	2
2	10K	10	2	—
3	10K	10	2	—
4	10K	10	2	2
5	10K	10	2	—
Etc.	Continue Cycling to Relay Failure			

The testing objective is to verify proper relay function for a given number of consecutive and cumulative cycles under both normal and abnormal conditions in a variety of load switching applications. The life rating of 40K cycles minimum was calculated with 95% Weibull reliability.

**Electrical Data  
(Over Temperature Range —  
Max. Terminal Temp. = 200°C)**
**Make/Break Life for Capacitive & Resistive Loads at 320 Vdc<sup>1,2</sup> —**

@ 90% Capacitive Pre-Charge —  
50,000 cycles

@ 70% Capacitive Pre-Charge —  
50 cycles

@ -250 A (2 Consecutive, Reverse  
Polarity)<sup>1</sup> — 10 cycles

@ 3300 A (Break only,  
2 Consecutive)<sup>1</sup> — 4 cycles

**Mechanical Life** — 100,000 cycles

**Notes:**

1 Resistive load includes inductance  
L = 25 μH. Load @ 2500 A tested  
@ 200 μH.

2 Conductor: 2 each of copper  
54 mm<sup>2</sup> (AWG 0) required for  
> 250 A carry. 1 Copper (AWG 0)  
conductor recommended for  
≤ 250 A

For factory-direct application assistance,  
dial 800-253-4560, ext. 2055, or  
805-220-2055.

## EV250-2A & 2B 400 Amps CZONKA II EVX Make & Break Load Switching

### Product Facts

- Hydrogen dielectric for power switching high current loads
- 400 A carry, 2,500 A interrupt @ 320 Vdc
- Suited for circuit protection, control, battery switching, and main power safety disconnect
- Versatile power, voltage, and current operating range: 28-1800 Vdc tested
- Internal coil economizer provides:
  - 4W typical hold power independent of temperature & voltage range
  - EMI spectrum tested and approved
  - Built-in coil suppression
- "Hammer effect" mechanism breaks light contact welds
- Hermetically "Super-sealed" environment chamber uniquely protects ALL moving parts
- Can operate in harsh environments
- Moving contact rotates to provide fresh contact surface for low contact resistance and low power consumption
- Sealed control connector. Mating connector with flying leads Part Number 2005 available
- Special versions available:
  - Economical (-8A/B) for light duty power switching (without arc blowout magnets)
  - 10 inch flying leads model (-7A)

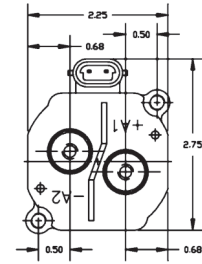
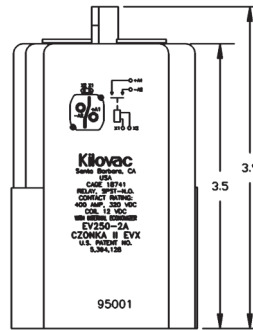
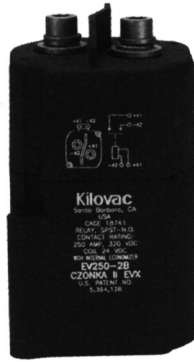

Note: Dimensions in inches. Multiply values by 25.4 for dimensions in mm.

### Product Specifications

**Contact Arrangement** — SPST-NO  
**Contact Form** — X  
**Continuous Current Carry, Max.** — 400 A; 6.5 Minutes — 500 A  
**Break Current @ 320 Vdc** — 2,500 A  
**Contact Resistance, Max.** — 0.0003 ohm  
**Contact Resistance, Typ.** — 0.0001 – 0.0002 ohm  
**Dielectric at Sea Level (Leakage < 1mA)** — 2,200 Vrms  
**Shock, 11ms, 1/2 Sine (Peak), Operating** — 30 g  
**Vibration, Sinusoidal (80-2000 Hz, Peak)** — 20 g  
**Operating Ambient Temperature Range** — -40°C to +85°C  
**Load Life** — See chart on next page  
**Operate Time, @ 25°C** —  
**Close (Includes Bounce), Typ.** — 18 ms  
**Bounce (After Close Only), Max.** — 5 ms  
**Release Time (Includes Arcing), Max.** — 15 ms  
**Insulation Resistance @ 500 Vdc, Min.** — 100 mohm  
**Weight, Nominal** — 1.76 lb (0.8 kg)

### Contact Ratings\*

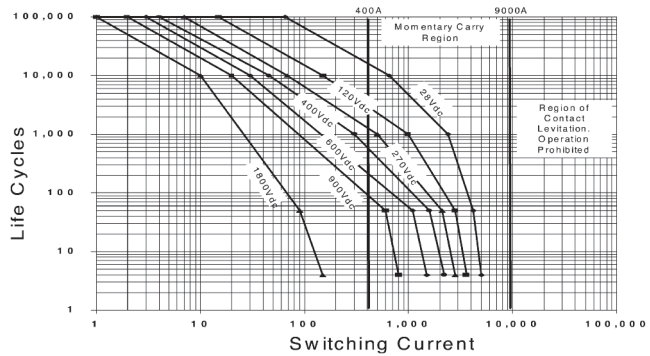

\*For circuit conditions and actual data refer to the EV250 hot switch study. Since each application is unique, user is encouraged to verify rating in actual application.

### Coil Data\*\*

	EV250-2A	EV250-2B
Voltage, Nominal*	12 Vdc	24 Vdc
Pickup (Close), Max.	9 Vdc	18 Vdc
Hold, Min.	7 Vdc	14 Vdc
Dropout (Open), Min.	5 Vdc	10 Vdc
Current (@ VsNom / 25°C)		
Inrush	2.8 A	1.8 A
Holding, Standby	0.34 A	0.11 A
Inrush Time, Max.	200 ms	200 ms

\*Other special coil voltages available upon request.

\*\*Do not use a free wheeling diode or capacitor across the coil. Built in suppression limits back EMF to zero volts.

### Ordering Information

Sample Part Number ► **EV250 -2 A**

Series: \_\_\_\_\_

Model: \_\_\_\_\_

2 = With Blowout Magnets  
 8 = Without Blowout Magnets  
 7 = 10" Flying Leads (12 V, with Magnets Only)

Coil Voltage: \_\_\_\_\_

A = 12 Vdc, Nominal  
 B = 24 Vdc, Nominal

For detailed specifications and recommendations, refer to the EV250-2A & B or 7A sales drawings.

For factory-direct application assistance, dial 800-253-4560, ext. 2055, or 805-220-2055.

**EV250-2A & 2B 400 Amps CZONKA II EVX Make & Break Load Switching** (Continued)

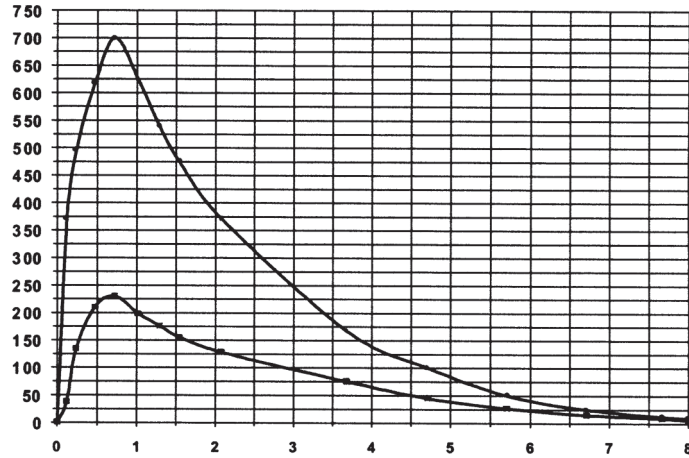
**CONTACTS CLOSED INTO 70% AND 90% CAPACITOR PRE CHARGE**

**Life Ratings and Qualification Test Plan**

Test #	Normal Operations		Abnormal Operations	
	1	2	3	4
Current	Reference Graph and Test Circuit Diagram (Sht. 8)		250 A	2500 A
Voltage			320 V	320 V
Load Type	Capacitive	Capacitive	Resistive	Resistive
% Pre Charge	90%	70%	NA	N/A
Switch Mode	Make Only	Make Only	Make/Break	Break Only
<b>Sequence</b>				
1	10K cycles	10 cycles	2	2
2	10K	10	2	—
3	10K	10	2	—
4	10K	10	2	2
5	10K	10	2	—
Etc.	Continue Cycling to Relay Failure			

The testing objective is to verify proper relay function for a given number of consecutive and cumulative cycles under both normal and abnormal conditions in a variety of load switching applications. The life rating of 40K cycles minimum was calculated with 95% Weibull reliability.

**Electrical Data  
(Over Temperature Range —  
Max. Terminal Temp. = 200°C)**
**Make/Break Life for Capacitive &  
Resistive Loads at 320 Vdc<sup>1,2</sup> —**

@ 90% Capacitive Pre-Charge —

50,000 cycles

@ 70% Capacitive Pre-Charge —

50 cycles

@ -250 A (2 Consecutive, Reverse

Polarity)<sup>1</sup> — 10 cycles

@ 3300 A (Break only,

2 Consecutive)<sup>1</sup> — 4 cycles

**Mechanical Life** — 100,000 cycles

**Notes:**

1 Resistive load includes inductance  
L = 25 μH. Load @ 2500 A tested  
@ 200 μH.

2 Conductor: 2 each of copper  
54 mm<sup>2</sup> (AWG 0) required for  
> 250 A carry. 1 Copper (AWG 0)  
conductor recommended for  
≤ 250 A

For factory-direct application assistance,  
dial 800-253-4560, ext. 2055, or  
805-220-2055.

## X-ON Electronics

Largest Supplier of Electrical and Electronic Components

*Click to view similar products for [Industrial Relays](#) category:*

*Click to view products by [TE Connectivity](#) manufacturer:*

Other Similar products are found below :

[6-1617801-8](#) [6-1618107-9](#) [7-1618273-3](#) [EV250-4A-02](#) [EV250-6A-01](#) [FCA-125-CX8](#) [FCA-325-159](#) [FCA-410-138](#) [8000-S3121](#) [8-1618273-6](#)  
[8-1618393-1](#) [GCA63A220VAC60HZ](#) [GCA63A277VAC60HZ](#) [GCA63A600VAC60HZ](#) [1-1672275-3](#) [1-1833005-4](#) [H-16/S1](#) [A711Z](#) [H-8C](#)  
[H-8/S11](#) [H-8/S68](#) [ACC530U20](#) [ACC730U30](#) [RF303ZM4-12](#) [DH18DA](#) [1423675-8](#) [AR4-15F13-C01](#) [AR7-41F11](#) [AVR907](#) [15732A200](#)  
[B07B032AC1-0329](#) [B329](#) [B490A](#) [1618279-1](#) [BHR124Y](#) [1810DDB-SX](#) [N417](#) [P30C42A12D1-120](#) [2-1617748-6](#) [2-1618375-1](#) [2-1618396-6](#)  
[2-1618398-1](#) [JMAPD-5XL](#) [JMGACD-5M](#) [JMGSC-5LW](#) [JMGSCD-5L](#) [PBO-18A1218](#) [PBO-40A3040](#) [K8DSPH1200480VAC](#) [KA-3C-12A](#)