

## Ni1000SOT

### Temperature Sensor

#### SPECIFICATIONS

- **Contact temperature sensing**
- **Comply with former DIN 43760 standard**
- **Small SMD package SOT 23**
- **Automotive qualified**

Ni1000SOT is a nickel thin film resistance temperature detector (RTD) that is suitable for use in contact temperature sensing. The devices are manufactured by PVD-deposition on a silicon substrate. The thin film structure is covered by a passivation layer for environmental protection and enhanced stability. The nickel elements are mounted on lead frames and encapsulated in SOT23 packages. This technology allows the production of miniature, low cost, high precision temperature sensors. The characteristics of the temperature sensor comply with the former DIN 43760 standard. It is qualified for the most demanding automotive applications (incl. exposure to hot oil) and is suitable for many more applications in harsh environments

## FEATURES

- Resistance: 1000 ohms at 0°C
- Min/ Max temp -55°C to +160°C
- Good linearity between resistance and temperature (R V's T)
- Large temperature coefficient of resistance: 6178 ppm/K (0°C, 100°C)
- Low power consumption
- Good thermal contact via Pin 3
- Tape and reel (8mm format)

## APPLICATIONS

- Temperature sensing, control and compensation
- General instrumentation
- Automotive (VW standard 801-01 vibration)
- Remote sensing

## PERFORMANCE SPECS

Parameter	Symbol	Condition	Min.	Typ.	Max.	Unit
Basic resistance	R <sub>0</sub>	0°C	997,81	1000	1002,20	Ω
Temperature coefficient of resistance (according to DIN 43760, see below)	TCR	0°C to +100°C	6100	6178	6240	ppm/K
Measurement current	I			0.2	5	mA
Self heating coefficient	EK	+23 °C, still air	1.4	1.7	2	mW/K
Operation temperature	T <sub>Op</sub>		-55		+160	°C
Maximum resistance drift	ΔR	1000h@150°C		0.1		%
Storage temperature	T <sub>St</sub>		-55		+160	°C
ESD resistant		MIL 883E3015.7		Class 1		

## SELF HEATING EFFECT

For accurate temperature measurement it is recommended to choose a small current to avoid self heating of the nickel sensing element. The temperature error caused by excessive measurement current can be calculated using:  $\Delta T = P/EK$

where  $P = I^2 \cdot R$  is the power generated by the measurement current and EK is the self heating coefficient.

## PACKAGE INFORMATION

Parameter	Condition	Typ.	Unit
Package		SOT23	
Soldering	Reflow to + 260°C	96Sn4Ag	
Packing units		13" (330 mm) / 10000	Reel Size / # of sensors
Package marking		Three Digit code: "1" + "XX", where "XX" is the revision.	

**TYPICAL PERFORMANCE CURVES**

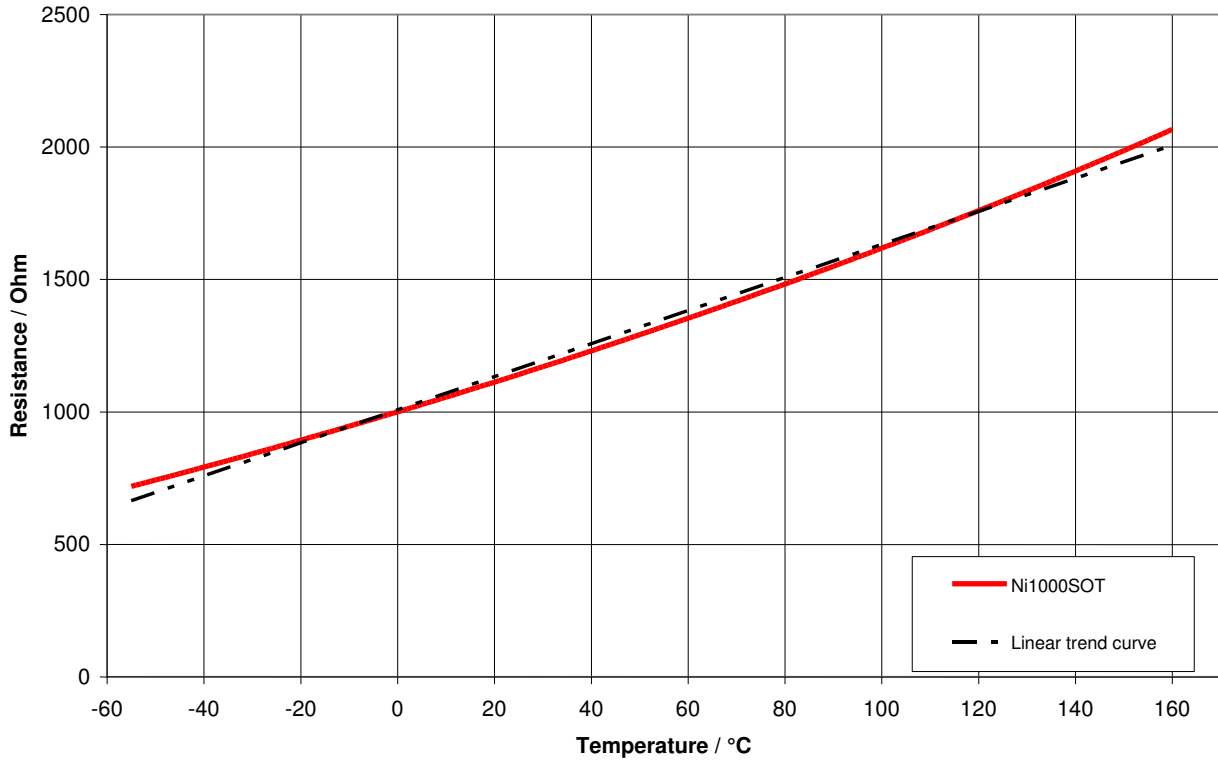

Resistance characteristics

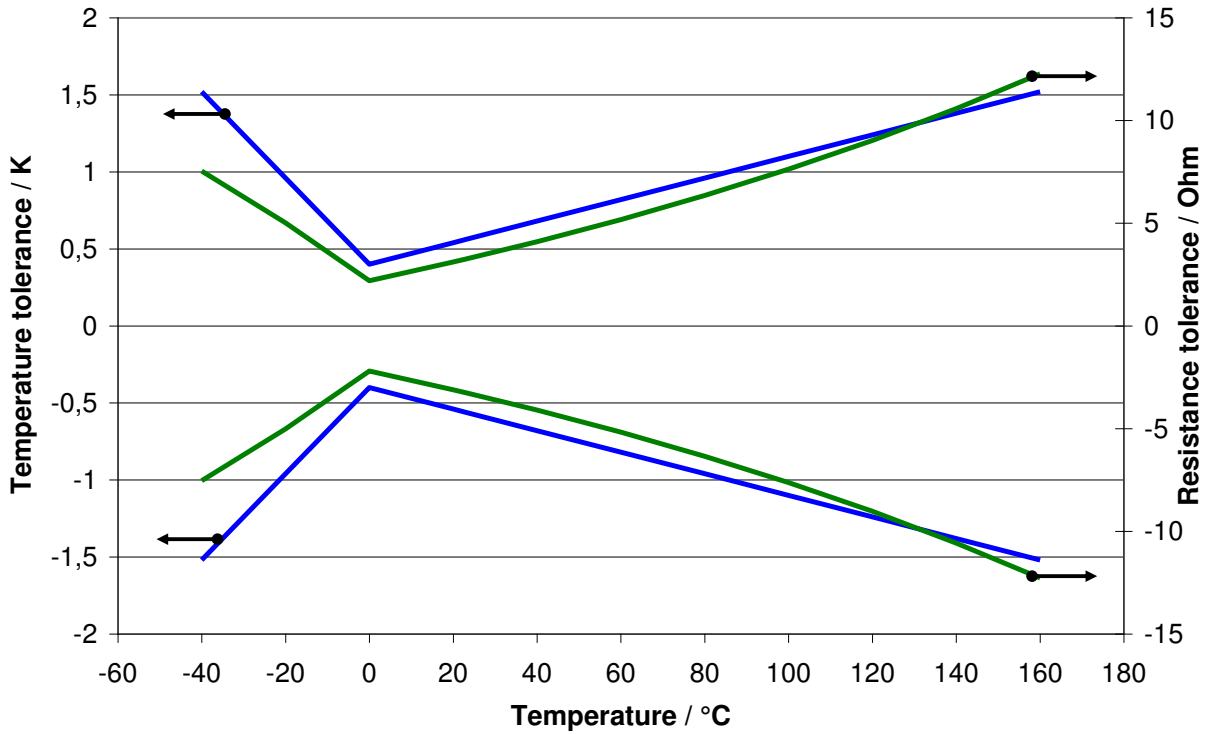

Tolerance chart

**ELECTRICAL CHARACTERISTIC**

The characteristic of the nickel temperature sensor is specified as per DIN 43760. The large Temperature Coefficient of Resistance (TCR) of the Ni-RTD, 6178 ppm/K, offers greater sensitivity than other types of RTD's. The electrical characteristic can be described by the following equation:

$$R(T) = R_0(1+aT+bT^2+cT^4+dT^6)$$

Coefficients:           a = 5.485 x 10<sup>-3</sup>  
                                   b = 6.650 x 10<sup>-6</sup>  
                                   c = 2.805 x 10<sup>-11</sup>  
                                   d = -2.000 x 10<sup>-17</sup>

$$T(R) = a' + b'(1+c'R)^{1/2} + d'R^5 + e'R^7 \quad dT < 0.12 \text{ K (higher order equations on request)}$$

Coefficients:           a' = - 412.6  
                                   b' = 140.41  
                                   c' = 0.00764  
                                   d' = - 6.25 x 10<sup>-17</sup>  
                                   e' = -1.25 x 10<sup>-24</sup>

**Tolerances:**               Class B           ± (0.4+0.007 x |T|)           in range from 0°C to +160 °C  
   ± (0.4+0.028 x |T|)           in range from -55°C to 0 °C

T/°C	0	1	2	3	4	5	6	7	8	9
-60	695.2	699.9	704.6	709.3	714.0	718.7	723.4	728.2	733.0	737.8
-50	742.6	747.4	752.2	757.0	761.9	766.8	771.6	776.5	781.4	786.4
-40	791.3	796.3	801.2	806.2	811.2	816.2	821.2	826.3	831.3	836.4
-30	841.5	846.5	851.7	856.8	861.9	867.0	872.2	877.4	882.6	887.8
-20	893.0	898.2	903.4	908.7	913.9	919.2	924.5	929.8	935.1	940.5
-10	945.8	951.2	956.5	961.9	967.3	972.7	978.2	983.6	989.1	994.5
0	1000.0	1005.5	1011.0	1016.5	1022.0	1027.6	1033.1	1038.7	1044.3	1049.9
10	1055.5	1061.1	1066.8	1072.4	1078.1	1083.8	1089.5	1095.2	1100.9	1106.6
20	1112.4	1118.1	1123.9	1129.7	1135.5	1141.3	1147.1	1153.0	1158.8	1164.7
30	1170.6	1176.5	1182.4	1188.3	1194.2	1200.2	1206.1	1212.1	1218.1	1224.1
40	1230.1	1236.1	1242.2	1248.2	1254.3	1260.4	1266.5	1272.6	1278.8	1284.9
50	1291.1	1297.2	1303.4	1309.6	1315.8	1322.0	1328.3	1334.5	1340.8	1347.1
60	1353.4	1359.7	1366.0	1372.4	1378.7	1385.1	1391.5	1397.9	1404.3	1410.8
70	1417.2	1423.7	1430.1	1436.6	1443.1	1449.7	1456.2	1462.8	1469.3	1475.9
80	1482.5	1489.1	1495.7	1502.4	1509.1	1515.7	1522.4	1529.1	1535.9	1542.6
90	1549.3	1556.1	1562.9	1569.7	1576.5	1583.4	1590.2	1597.1	1604.0	1610.9
100	1617.8	1624.7	1631.7	1638.6	1645.6	1652.6	1659.6	1666.7	1673.7	1680.8
110	1687.9	1695.0	1702.1	1709.3	1716.4	1723.6	1730.8	1738.0	1745.2	1752.5
120	1759.7	1767.0	1774.3	1781.6	1788.9	1796.3	1803.7	1811.1	1818.5	1825.9
130	1833.3	1840.8	1848.3	1855.8	1863.3	1870.9	1878.4	1886.0	1893.6	1901.2
140	1908.9	1916.5	1924.2	1931.9	1939.6	1947.4	1955.1	1962.9	1970.7	1978.5
150	1986.3	1994.2	2002.1	2010.0	2017.9	2025.9	2033.8	2041.8	2049.8	2057.8
160	2065.9	2074.0	2082.1	2090.2	2098.3	2106.5	2114.6	2122.8	2131.1	2139.3

## MECHANICAL DIMENSIONS

### PACKAGE DIMENSIONS SOT23

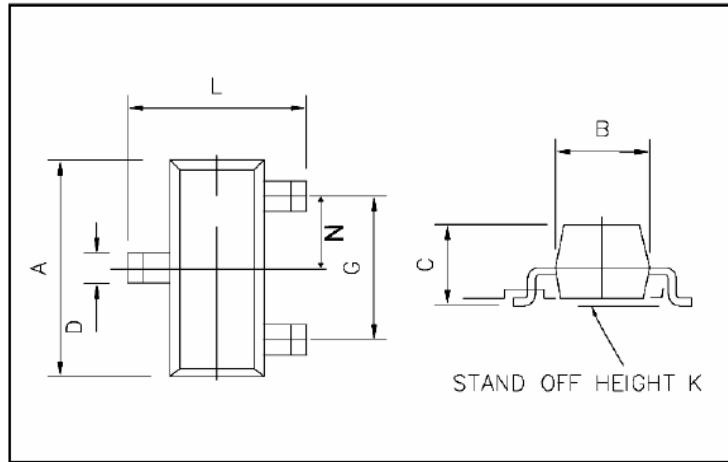

DIM	Millimeters		Inches	
	Min	Max	Min	Max
A	2.67	3.05	0.1051	0.1201
B	1.20	1.40	0.0472	0.0551
C	0.89	1.12	0.0350	0.0441
D	0.37	0.53	0.0146	0.0209
G	1.78	2.05	0.0701	0.0807
K	0.01	0.10	0.0004	0.0039
L	2.10	2.64	0.0827	0.1039
N	0.89	1.03	0.0350	0.0406

### PIN DIMENSIONS

Dimension	Millimeters		Inches	
	Min	Max	Min	Max
Pin Thickness	0.085	0.18	0.0033	0.0071

### CONNECTIONS

Top view: 	Pin # 1	Nickel RTD electrical contact
	Pin # 2	Nickel RTD electrical contact
	Pin # 3	Electrically isolated thermal contact

## APPLICATION NOTE 1

### Analogue Interface Circuit for general purpose measurement

The following voltage dividing circuit can be used for low accuracy measurements. There is no linearization given.

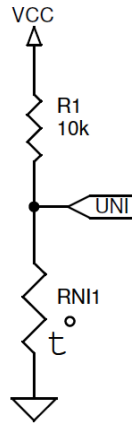

Example of voltage dividing circuit using Ni1000SOT sensor

The output voltage will be calculated by the following equation:

$$UNI = RNI1 / (R1 + RNI1) \cdot VCC$$

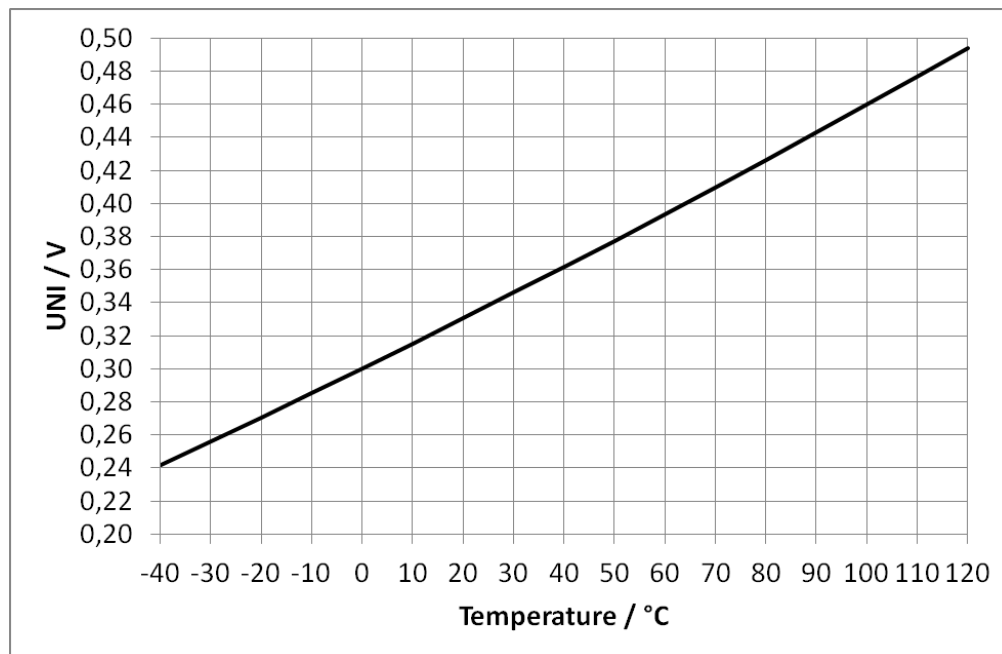

Output voltage characteristics with VCC = 3.3V

## APPLICATION NOTE 2

### Analogue Interface Circuit for high accuracy measurement

The following circuitry utilizes the output of a bridge circuitry which is amplified in order to improve the measurement resolution. By bridging RNI with an optional 3.65kOhm resistor this circuitry can be linearized.

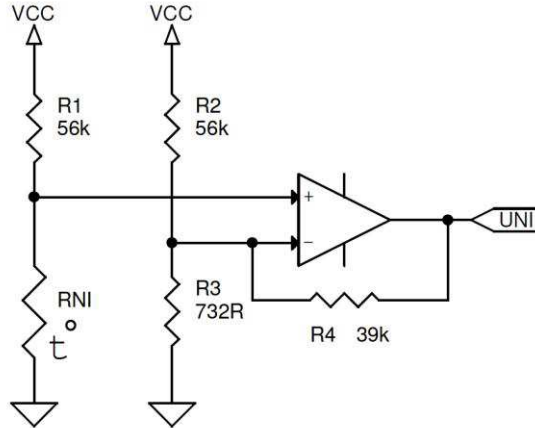

Example of analog interface circuit for high accuracy measurement using Ni1000SOT sensor

The output voltage will be calculated by the following equation:

$$UNI = \frac{RNI}{R1+RNI} \cdot VCC \cdot [1 + R4 \cdot (1/R2 + 1/R3)] - R4/R2 \cdot VCC$$

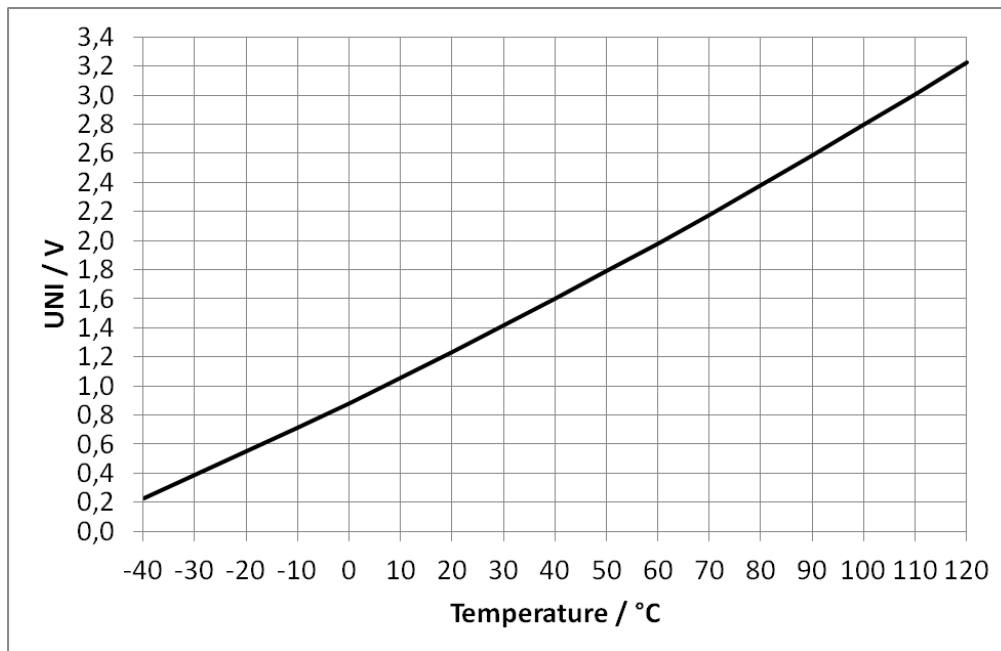

Output voltage characteristics with VCC = 3.3V

**ORDER INFORMATION**

Please order this product using following:	
Part Number	Part Description
G-NICO-001	Ni1000SOT

**DEFINITIONS AND DISCLAIMERS**

- Application information – Applications that are described herein for any of these products are for illustrative purpose only. MEAS Deutschland GmbH makes no representation or warranty that such applications will be suitable for the specified use without further testing or modification.
- Life support applications – These products are not designed for use in life support appliances, devices, or systems where malfunctions of these products can reasonably be expected to result in personal injury. MEAS Deutschland GmbH customers using or selling this product for use in such applications do so at their own risk and agree to fully indemnify MEAS Deutschland GmbH for any damages resulting from such improper use or sale.

**NORTH AMERICA**

Measurement Specialties, Inc.,  
a TE Connectivity Company  
910 Turnpike Road  
Shrewsbury, MA 01545  
United States  
Phone: +1-508-842-0516  
Fax: +1-508-842-0342  
Email: temperature.sales.amer@meas-spec.com  
Web: www.meas-spec.com

**EUROPE**

Measurement Specialties (Europe), Ltd.,  
a TE Connectivity Company  
Deutschland GmbH  
Hauert 13  
D-44227 Dortmund  
Germany  
Phone: +49-(0)231-9740-0  
Fax: +49-(0)231-9740-20  
Email: info.de@meas-spec.com  
Web: www.meas-spec.com

**ASIA**

Measurement Specialties (China), Ltd.,  
a TE Connectivity Company  
No. 26 Langshan Road  
Shenzhen High-Tech Park (North)  
Nanshan District, Shenzhen 518057  
China  
Tel: +86 755 3330 5088  
Fax: +86 755 3330 5099  
Email: temperature.sales.asia@meas-spec.com  
Web: www.meas-spec.com

**TE.com/sensorsolutions**

Measurement Specialties, Inc., a TE Connectivity company.

Measurement Specialties, TE Connectivity, TE Connectivity (logo) and EVERY CONNECTION COUNTS are trademarks. All other logos, products and/or company names referred to herein might be trademarks of their respective owners.

The information given herein, including drawings, illustrations and schematics which are intended for illustration purposes only, is believed to be reliable. However, TE Connectivity makes no warranties as to its accuracy or completeness and disclaims any liability in connection with its use. TE Connectivity's obligations shall only be as set forth in TE Connectivity's Standard Terms and Conditions of Sale for this product and in no case will TE Connectivity be liable for any incidental, indirect or consequential damages arising out of the sale, resale, use or misuse of the product. Users of TE Connectivity products should make their own evaluation to determine the suitability of each such product for the specific application.

© 2015 TE Connectivity Ltd. family of companies All Rights Reserved.



## X-ON Electronics

Largest Supplier of Electrical and Electronic Components

*Click to view similar products for [Board Mount Temperature Sensors](#) category:*

*Click to view products by [TE Connectivity](#) manufacturer:*

Other Similar products are found below :

[5962-8757102XA](#) [66F115](#) [EMC1063-1-ACZL-TR](#) [NCT218FCT2G](#) [O53GAB175A-160Y](#) [3610085020002](#) [389049M9527](#) [ADM1023ARQZ-REEL](#) [ADM1032ARMZ-1RL](#) [AT30TS74-U1FMDB-T](#) [AT30TS74-U1FMAB-T](#) [AT30TS74-U1FMCB-T](#) [AT30TS74-U1FMDB-T](#) [ADT7483AARQZ-RL](#) [ADT7481ARMZ-REEL](#) [ADT7463ARQZ-REEL](#) [66L080-0226](#) [5962-8757103XA](#) [S-58LM20A-I4T1U](#) [NCT375MNR2G](#) [LM84CIMQA](#) [CAT34TS00VP2GT4A](#) [NCT80DBR2G](#) [SEN-16304](#) [GX21M15](#) [GX122](#) [MAX31875R5TZS+T](#) [MAX31875R6TZS+T](#) [TC6501P065VCTTR](#) [AT-1U](#) [MCP9700AT-E/LT](#) [MCP9701-E/TO](#) [MCP9803-M/MS](#) [MCP9701A-E/TO](#) [MCP9701AT-E/LT](#) [LM57FEPWQ1](#) [LM57FPW](#) [LM57FSPWQ1](#) [60-41123102-0150.0010](#) [60-43123102-0150.0010](#) [60-53123102-0150.0010](#) [MLX90615SSG-DAA-000-TU](#) [TMP303CDRLR](#) [TC6501P055VCTTR](#) [TC6503P005VCTTR](#) [ADT7311WTRZ-RL7](#) [ADT7473ARQZ-REEL](#) [LM45BIM3X/NOPB](#) [LM63DIMA/NOPB](#) [LM75BIM-3](#)