

KRPA Series Panel Plug-in Relay

- 5 to 10A current capability
- Contact arrangements of 1, 2 and 3 form C (CO)
- Octal type termination for quick installation
- Indicator lamp available on certain models

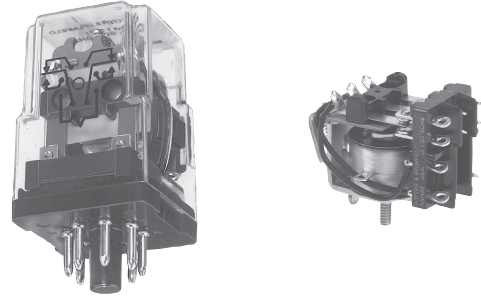

Typical applications
Baggage handling, lighting, inspection equipment, marine.

Approvals

UL E22575; CSA LR15734
Technical data of approved types on request.

Contact Data

Contact arrangement	1 form C (CO), 2 form C (CO), 3 form C (CO)	
Rated voltage	240VAC	
Rated current	10A	
Contact material	Ag	AgCdO
Min. recommended contact load	100mA, 12VDC	300mA, 12VDC
Frequency of operation	360 ops./hour	360 ops./hour

Contact ratings

Type	Load	Cycles
UL 508		
KRPA, Ag	5A, 120VAC	100x10 ³
	3A, 240VAC	100x10 ³
	1/10HP, 120VAC	1x10 ³
	1/6HP, 240VAC	1x10 ³
KRPA, AgCdO	10A, 240VAC	100x10 ³
	1/3HP, 120VAC	1x10 ³
	1/2HP, 240VAC	1x10 ³
KA, Ag	5A, 120VAC	
	3A, 240VAC	
	1/10HP, 120VAC	
	1/6HP, 240VAC	
KA, AgCdO	10A, 120VAC	
	6A, 240VAC	
	1/6HP, 120VAC	
	1/3HP, 240VAC	
Mechanical endurance		10x10 ⁶ ops.

Coil Data

Coil voltage range	6 to 220VDC 6 to 240VAC
Coil insulation system according UL	Class B

Coil versions, DC coil

Coil code	Rated voltage VDC	Operate voltage VDC	Coil resistance Ω±10%	Rated coil power W
6	6	4.5	32	1.15
12	12	9.0	120	1.2
24	24	18.0	472	1.25
48	48	36.0	1800	1.3
110	110	82.5	10000	1.2
-	220	Use 110V relay with 10KΩ, 5W resistor in series		

All figures are given for coil without preenergization, at ambient temperature +23°C.

Coil Data (continued)

Coil versions, AC coil

Coil code	Rated voltage VAC	Operate voltage VAC	Coil resistance Ω±15%	Rated coil power VA
6	6	5.1	6	2.01
12	12	10.2	24	2.02
24	24	20.4	85	2.02
120	120	102.0	2250	2.1
240	240	204.0	9110	2.1

All figures are given for coil without preenergization, at ambient temperature +23°C.

Insulation Data

Initial dielectric strength		
between open contacts		1000V _{rms}
between contact and coil		1000V _{rms}
between adjacent contacts		1000V _{rms}
Initial insulation resistance		
between insulated elements		KRPA: 1000MΩ KA: 100MΩ

Other Data

Material compliance: EU RoHS/ELV, China RoHS, REACH, Halogen content refer to the Product Compliance Support Center at www.te.com/customer-support/rohssupportcenter

Ambient temperature		
DC coil		KRPA: -45°C to 70°C KA: -45°C to 85°C
AC coil		KRPA: -45°C to 55°C KA: -45°C to 70°C
Category of environmental protection		
IEC 61810		RT1 - dust protected KRPA and RTO - open style KA
Terminal type		KRPA: 8- or 11-pin octal-type plug KA: solder terminals
Weight		85g
Packaging/unit		tray/25 pcs., box/150pcs.

Accessories

For details see datasheet Sockets and Accessories, KRPA Relays

Product Code	Description
27E891	Two pole DIN socket (use 20C318 clip)
27E892	Three pole DIN socket (use 20C318 clip)
27E122	Two pole track mount socket (use 20C318 clip)
27E123	Three pole track mount socket (use 20C318 clip)

KRPA Series Panel Plug-in Relay (Continued)

Dimensions

KRPA

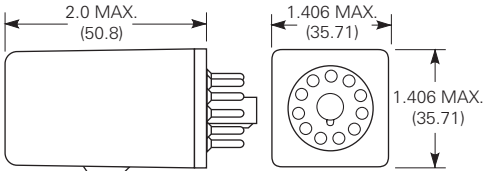

KA

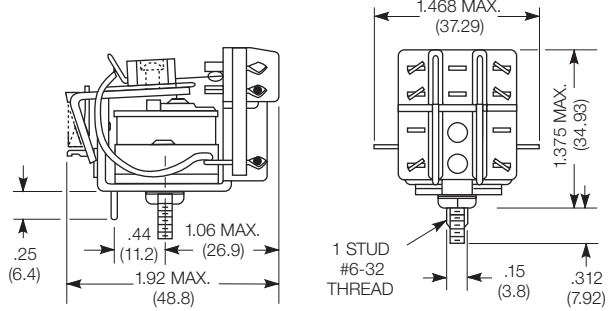

Terminal assignment

KRPA

1 form C

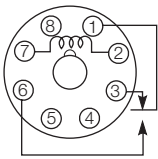

KRPA

2 form C

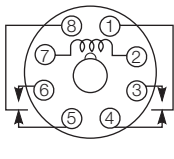

KRPA

3 form C

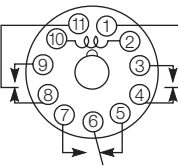

KA

1 form C

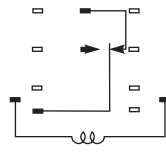

KA

2 form C

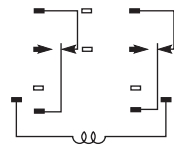

KA

3 form C

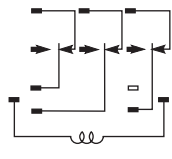

Product code structure

Typical product code

KRPA -5 A Y -120

Type

KRPA Enclosed relay with octal-style plug
KA Open style relay with solder terminals

Contact arrangement and rating

5 1 form C (CO) **11** 2 form C (CO)
14 3 form C (CO)

Coil Input

A AC, 50/60Hz **D** DC

Contact material and indicator lamp option

Y Ag, no indicator lamp **G** AgCdO, no indicator lamp
N AgCdO, with indicator (Code N only available with relay type KRPA)

Options

Leave blank no additional options
F Au flashed contacts **P** Push to test button
(Options F and P only available with relay type KRPA)

Coil voltage

Coil code: please refer to coil versions table

KRPA Series Panel Plug-in Relay (Continued)

Product Code	Arrangement	Contact Material	Coil	Option	Part Number		
KA-5AG-120	1 form C, 1 CO	AgCdO	120VAC	Open style	7-1393099-1		
KA-5AY-120		Ag			7-1393099-3		
KA-5DG-6		AgCdO			6VDC	7-1393099-9	
KA-5DG-12					12VDC	7-1393099-7	
KA-5DG-110	2 form C, 2 CO		110VDC		7-1393099-6		
KA-11AG-120			120VAC		3-1393099-6		
KA-11AY-6		Ag	6VAC		4-1393099-1		
KA-11AY-24			24VAC		4-1393099-0		
KA-11AY-120			120VAC		3-1393099-9		
KA-11DG-12		AgCdO	12VDC		4-1393099-3		
KA-11DG-24			24VDC		4-1393099-5		
KA-11DG-110			110VDC		4-1393099-2		
KA-14AG-120		3 form C, 3 CO		120VAC		5-1393099-0	
KA-14AY-120			Ag			5-1393099-4	
KA-14DG-24	AgCdO		24VDC		5-1393099-7		
KA-14DG-110			110VDC		5-1393099-5		
KRPA-5AG-24	1 form C, 1 CO			24VAC	None	9-1393104-9	
KRPA-5AG-120				120VAC		9-1393104-8	
KRPA-5DG-6			6VDC	1393105-5			
KRPA-5DG-12			12VDC	1393105-3			
KRPA-5DG-24			24VDC	1393105-4			
KRPA-5DY-12		Ag	12VDC			1393105-6	
KRPA-5DY-24			24VDC			1393105-7	
KRPA-11AG-6		2 form C, 2 CO	AgCdO	6VAC			2-1393104-8
KRPA-11AG-12				12VAC			2-1393104-4
KRPA-11AG-24				24VAC			1-1393105-2
KRPA-11AG-120			120VAC		2-1393104-5		
KRPA-11AG-240			240VAC		2-1393104-7		
KRPA-11AN-12			12VAC	Indicator	3-1393104-1		
KRPA-11AN-24			24VAC		3-1393104-3		
KRPA-11AN-120			120VAC		3-1393104-2		
KRPA-11AN-240			240VAC		3-1393104-4		
KRPA-11AY-6	Ag		AgCdO	6VAC	None	3-1393104-9	
KRPA-11AY-12		12VAC		3-1393104-5			
KRPA-11AY-24		24VAC		3-1393104-7			
KRPA-11AY-120		120VAC		3-1393104-6			
KRPA-11AY-240		240VAC		3-1393104-8			
KRPA-11DG-6				6VDC			4-1393104-7
KRPA-11DG-12				12VDC			4-1393104-3
KRPA-11DG-24				24VDC			4-1393104-5
KRPA-11DG-48				48VDC			4-1393104-6
KRPA-11DG-110				110VDC			4-1393104-2
KRPA-11DG-125		125VDC		4-1393104-4			
KRPA-11DG-24		24VDC		4-1393104-5			
KRPA-11DG-48		48VDC		4-1393104-6			
KRPA-11DN-12		12VDC	Indicator	5-1393104-0			
KRPA-11DN-24		24VDC		5-1393104-1			
KRPA-11DN-110		110VDC		4-1393104-9			
KRPA-11DY-12	Ag	AgCdO	12VDC	None	5-1393104-6		
KRPA-11DY-24			24VDC		5-1393104-7		
KRPA-14AG-12	3 form C, 3 CO	AgCdO	12VAC		6-1393104-4		
KRPA-14AG-24			24VAC		6-1393104-7		
KRPA-14AG-120			120VAC		6-1393104-5		
KRPA-14AG-240			240VAC		6-1393104-8		
KRPA-14AN-24			24VAC	Indicator	7-1393104-4		
KRPA-14AN-120			120VAC		7-1393104-3		
KRPA-14AN-240			240VAC		7-1393104-5		
KRPA-14AY-24			Ag	AgCdO	24VAC	None	7-1393104-8
KRPA-14AY-120					120VAC		7-1393104-7
KRPA-14AY-240					240VAC		7-1393104-9
KRPA-14DG-12	AgCdO	AgCdO	12VDC		8-1393104-2		
KRPA-14DG-24			24VDC		8-1393104-4		
KRPA-14DG-48			48VDC		8-1393104-5		
KRPA-14DG-110			110VDC		8-1393104-1		
KRPA-14DG-125			125VDC		8-1393104-3		
KRPA-14DN-24				24VDC	Indicator	9-1393104-0	
KRPA-14DY-24			Ag			None	9-1393104-3

X-ON Electronics

Largest Supplier of Electrical and Electronic Components

Click to view similar products for [General Purpose Relays](#) category:

Click to view products by [TE Connectivity](#) manufacturer:

Other Similar products are found below :

[PCN-105D3MH,000](#) [59641F200](#) [5JO-1000CD-SIL](#) [LY1SAC110120](#) [5X827E](#) [5X837F](#) [5X840F](#) [5X842F](#) [5X848E](#) [LY2N-AC120](#) [LY2S-AC220/240](#) [LY2-US-AC120](#) [LY3-US-AC120](#) [LY4F-UA-DC12](#) [LY4F-UA-DC24](#) [LY4F-US-AC120](#) [LY4F-US-AC240](#) [LY4F-US-DC24](#) [LY4F-VD-AC110](#) [LYQ20DC12](#) [M115C60](#) [M115N010](#) [M115N0150](#) [6031007G](#) [603-12D](#) [61211T0B4](#) [61212T400](#) [61222Q400](#) [61243B600](#) [61243C500](#) [61243Q400](#) [61311BOA2](#) [61311BOA6](#) [61311BOA8](#) [61311C0A2](#) [61311COA1](#) [61311COA6](#) [61311F0A2](#) [61311QOA1](#) [61311QOA4](#) [61311T0D6](#) [61311TOA6](#) [61311TOA7](#) [61311TOB3](#) [61311TOB4](#) [61311U0A6](#) [61312Q600](#) [61312T400](#) [61312T600](#) [61313U200](#)