

4

3

2

1

THIS DRAWING IS UNPUBLISHED. RELEASED FOR PUBLICATION 2009  
 © COPYRIGHT 2009 BY TYCO ELECTRONICS CORPORATION. ALL RIGHTS RESERVED.

LOC	DIST	REVISIONS			
P	LTR	DESCRIPTION	DATE	DWN	APVD
E	B	BA	NEW RELEASE	05-OCT-09	MRS St.P

FOR FURTHER INFORMATION SEE DATA SHEET FOR SERIES LR, METAL FILM FIXED RESISTORS

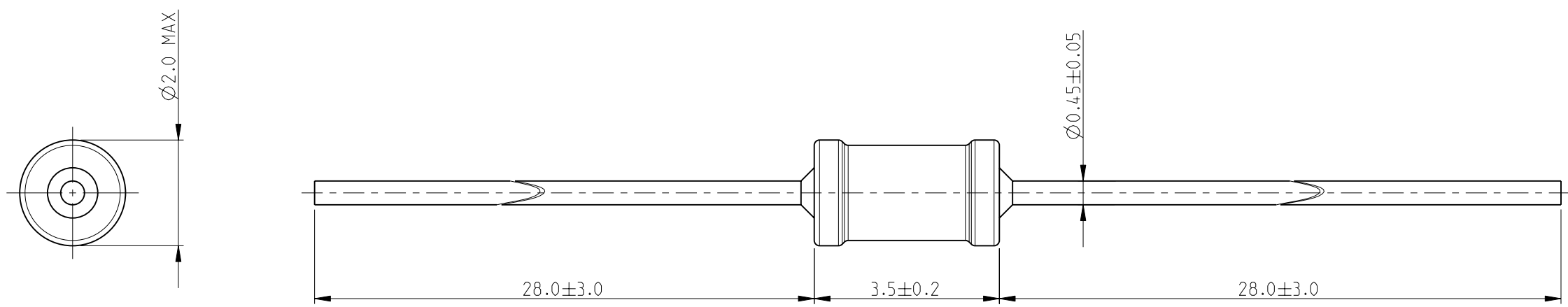

RoHS Compliant

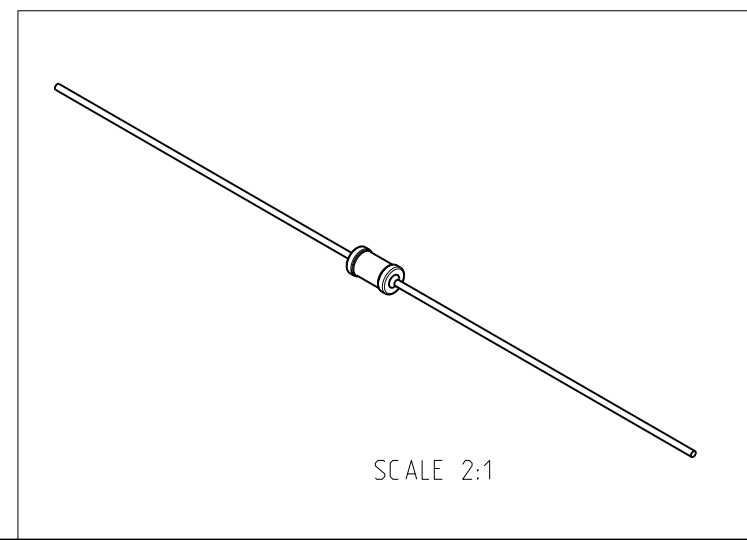

<small>THIS DRAWING IS A CONTROLLED DOCUMENT FOR TYCO ELECTRONICS CORPORATION IT IS SUBJECT TO CHANGE AND THE CONTROLLING ENGINEERING ORGANIZATION SHOULD BE CONTACTED FOR THE LATEST REVISION.</small>		DWN MAHARUDRA 05-OCT-09 CHK ALLAN.P 05-OCT-09 APVD STEPHEN.P 05-OCT-09		Tyco Electronics Corporation Dorcan, Swindon, SN3 5HH	
DIMENSIONS: mm		TOLERANCES UNLESS OTHERWISE SPECIFIED: 0 PLC $\pm 0.2$ 1 PLC $\pm 0.1$ 2 PLC $\pm -$ 3 PLC $\pm -$ 4 PLC $\pm -$ ANGLES $\pm 5^\circ$		NAME METAL FILM FIXED RESISTORS SERIES LR0204	
MATERIAL -		FINISH -		PRODUCT SPEC - APPLICATION SPEC - WEIGHT -	
CUSTOMER DRAWING				SIZE A3 CAGE CODE 00779 DRAWING NO C-1622251	RESTRICTED TO -
SCALE 10:1				SHEET 1 OF 1	REV BA

## X-ON Electronics

Largest Supplier of Electrical and Electronic Components

*Click to view similar products for [Metal Film Resistors - Through Hole](#) category:*

*Click to view products by [TE Connectivity](#) manufacturer:*

Other Similar products are found below :

[MF2S-6K8JI](#) [GP55S-1002-FTW](#) [GP55S-1004-FTW](#) [GP55S-4753-FTW](#) [QW210](#) [RCFH-0.5-5TA](#) [RCFH-100-5TA](#) [RCFH-10-5TA](#) [RCFH-110-5TA](#) [RCFH-11K-5TA](#) [RCFH-11M-5TA](#) [RCFH-12K-5TA](#) [RCFH-130K-5TA](#) [RCFH-13-5TA](#) [RCFH-13K-5TA](#) [RCFH-13M-5TA](#) [RCFH-150K-5TA](#) [RCFH-15-5TA](#) [RCFH-160-5TA](#) [RCFH-160K-5TA](#) [RCFH-16-5TA](#) [RCFH-180K-5TA](#) [RCFH-18K-5TA](#) [RCFH-1M-5TA](#) [RCFH-200-5TA](#) [RCFH-200K-5TA](#) [RCFH-20K-5TA](#) [RCFH-220-5TA](#) [RCFH-220K-5TA](#) [RCFH-22K-5TA](#) [RCFH-2.2M-5TA](#) [RCFH-240K-5TA](#) [RCFH-24K-5TA](#) [RCFH-2-5TA](#) [RCFH-27-5TA](#) [RCFH-27K-5TA](#) [RCFH-2M-5TA](#) [RCFH-330-5TA](#) [RCFH-33-5TA](#) [RCFH-3.3M-5TA](#) [RCFH-360-5TA](#) [RCFH-360K-5TA](#) [RCFH-3.6M-5TA](#) [RCFH-39-5TA](#) [RCFH-39K-5TA](#) [RCFH-3.9M-5TA](#) [RCFH-430-5TA](#) [RCFH-47K-5TA](#) [RCFH-510K-5TA](#) [RCFH-51-5TA](#)