

4

3

2

1

THIS DRAWING IS UNPUBLISHED. RELEASED FOR PUBLICATION 2010
 © COPYRIGHT 2010 BY TYCO ELECTRONICS CORPORATION. ALL RIGHTS RESERVED.

LOC	DIST	REVISIONS			
P	LTR	DESCRIPTION	DATE	DWN	APVD
E	B	BA	NEW RELEASE	19-FEB-10	MRS St.P

FOR FURTHER INFORMATION SEE DATA SHEET FOR SERIES LR, METAL FILM FIXED RESISTORS

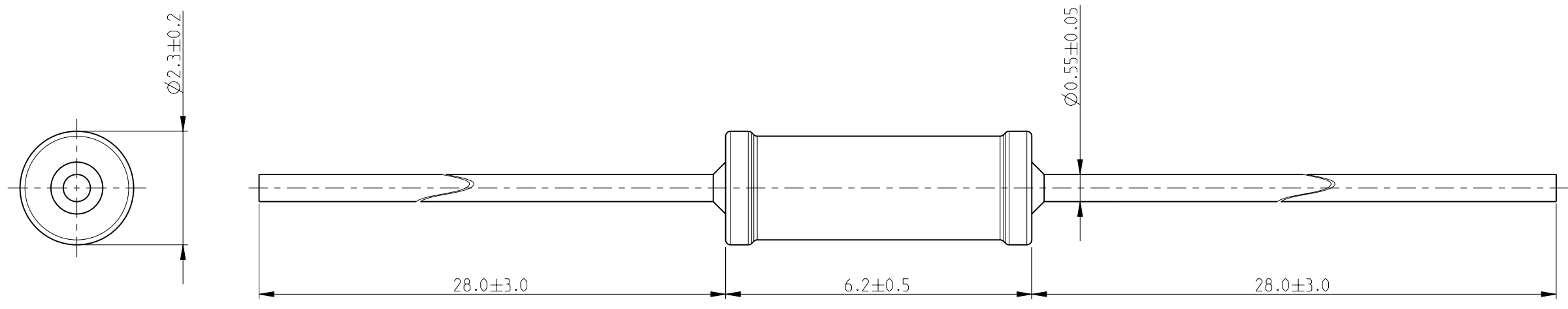

RoHS Compliant

<small>THIS DRAWING IS A CONTROLLED DOCUMENT FOR TYCO ELECTRONICS CORPORATION IT IS SUBJECT TO CHANGE AND THE CONTROLLING ENGINEERING ORGANIZATION SHOULD BE CONTACTED FOR THE LATEST REVISION.</small>		DWN MAHARUDRA 19-FEB-10 CHK ALLAN.P 19-FEB-10 APVD STEPHEN.P 19-FEB-10	Tyco Electronics Corporation Dorcan, Swindon, SN3 5HH	
DIMENSIONS: mm	TOLERANCES UNLESS OTHERWISE SPECIFIED: 0 PLC ± 0.2 1 PLC ± 0.1 2 PLC ± - 3 PLC ± - 4 PLC ± - ANGLES ± 5°	PRODUCT SPEC - APPLICATION SPEC - WEIGHT -	NAME METAL FILM FIXED RESISTORS SERIES LR1	
MATERIAL -	FINISH -	SIZE A3 CAGE CODE 00779 DRAWING NO C-1622321	RESTRICTED TO -	
CUSTOMER DRAWING		SCALE 10:1	SHEET 1 OF 1	REV BA

X-ON Electronics

Largest Supplier of Electrical and Electronic Components

Click to view similar products for [Metal Film Resistors - Through Hole](#) category:

Click to view products by [TE Connectivity](#) manufacturer:

Other Similar products are found below :

[MF2S-6K8JI](#) [GP55S-1002-FTW](#) [GP55S-1004-FTW](#) [GP55S-4753-FTW](#) [QW210](#) [RCFH-0.5-5TA](#) [RCFH-100-5TA](#) [RCFH-10-5TA](#) [RCFH-110-5TA](#) [RCFH-11K-5TA](#) [RCFH-11M-5TA](#) [RCFH-12K-5TA](#) [RCFH-130K-5TA](#) [RCFH-13-5TA](#) [RCFH-13K-5TA](#) [RCFH-13M-5TA](#) [RCFH-150K-5TA](#) [RCFH-15-5TA](#) [RCFH-160-5TA](#) [RCFH-160K-5TA](#) [RCFH-16-5TA](#) [RCFH-180K-5TA](#) [RCFH-18K-5TA](#) [RCFH-1M-5TA](#) [RCFH-200-5TA](#) [RCFH-200K-5TA](#) [RCFH-20K-5TA](#) [RCFH-220-5TA](#) [RCFH-220K-5TA](#) [RCFH-22K-5TA](#) [RCFH-2.2M-5TA](#) [RCFH-240K-5TA](#) [RCFH-24K-5TA](#) [RCFH-2-5TA](#) [RCFH-27-5TA](#) [RCFH-27K-5TA](#) [RCFH-2M-5TA](#) [RCFH-330-5TA](#) [RCFH-33-5TA](#) [RCFH-3.3M-5TA](#) [RCFH-360-5TA](#) [RCFH-360K-5TA](#) [RCFH-3.6M-5TA](#) [RCFH-39-5TA](#) [RCFH-39K-5TA](#) [RCFH-3.9M-5TA](#) [RCFH-430-5TA](#) [RCFH-47K-5TA](#) [RCFH-510K-5TA](#) [RCFH-51-5TA](#)