

4

3

2

1

THIS DRAWING IS UNPUBLISHED. RELEASED FOR PUBLICATION 2010  
 © COPYRIGHT 2010 BY TYCO ELECTRONICS CORPORATION. ALL RIGHTS RESERVED.

| LOC | DIST | REVISIONS   |             |           |          |
|-----|------|-------------|-------------|-----------|----------|
| P   | LTR  | DESCRIPTION | DATE        | DWN       | APVD     |
| E   | B    | BA          | NEW RELEASE | 19-FEB-10 | MRS St.P |

FOR FURTHER INFORMATION SEE DATA SHEET FOR SERIES LR, METAL FILM FIXED RESISTORS

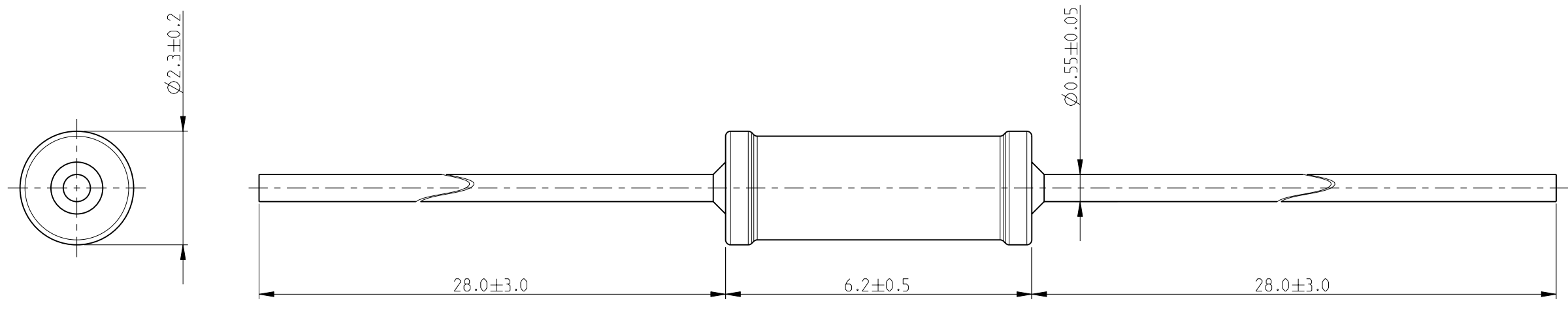

RoHS Compliant



|   |   |  |  |        |  |
|---|---|--|--|--------|--|
| <small>THIS DRAWING IS A CONTROLLED DOCUMENT FOR TYCO ELECTRONICS CORPORATION IT IS SUBJECT TO CHANGE AND THE CONTROLLING ENGINEERING ORGANIZATION SHOULD BE CONTACTED FOR THE LATEST REVISION.</small> |   | DWN MAHARUDRA 19-FEB-10<br>CHK ALLAN.P 19-FEB-10<br>APVD STEPHEN.P 19-FEB-10 | Tyco Electronics Corporation<br>Dorcan, Swindon, SN3 5HH |        |  |
| DIMENSIONS:<br>mm   | TOLERANCES UNLESS OTHERWISE SPECIFIED:<br>0 PLC $\pm 0.2$<br>1 PLC $\pm 0.1$<br>2 PLC $\pm -$<br>3 PLC $\pm -$<br>4 PLC $\pm -$<br>ANGLES $\pm 5^\circ$ | PRODUCT SPEC -<br>APPLICATION SPEC -<br>WEIGHT -                             | NAME METAL FILM FIXED RESISTORS SERIES LR1               |        |  |
| MATERIAL -  | FINISH -  | SIZE A3<br>CAGE CODE 00779<br>DRAWING NO C-1622523                           | RESTRICTED TO -  |        |  |
| CUSTOMER DRAWING  |   | SCALE 10:1   | SHEET 1 OF 1   | REV BA |  |

## X-ON Electronics

Largest Supplier of Electrical and Electronic Components

*Click to view similar products for [Metal Film Resistors - Through Hole](#) category:*

*Click to view products by [TE Connectivity](#) manufacturer:*

Other Similar products are found below :

[MF2S-6K8JI](#) [GP55S-1002-FTW](#) [GP55S-1004-FTW](#) [GP55S-4753-FTW](#) [QW210](#) [RCFH-0.5-5TA](#) [RCFH-100-5TA](#) [RCFH-10-5TA](#) [RCFH-110-5TA](#) [RCFH-11K-5TA](#) [RCFH-11M-5TA](#) [RCFH-12K-5TA](#) [RCFH-130K-5TA](#) [RCFH-13-5TA](#) [RCFH-13K-5TA](#) [RCFH-13M-5TA](#) [RCFH-150K-5TA](#) [RCFH-15-5TA](#) [RCFH-160-5TA](#) [RCFH-160K-5TA](#) [RCFH-16-5TA](#) [RCFH-180K-5TA](#) [RCFH-18K-5TA](#) [RCFH-1M-5TA](#) [RCFH-200-5TA](#) [RCFH-200K-5TA](#) [RCFH-20K-5TA](#) [RCFH-220-5TA](#) [RCFH-220K-5TA](#) [RCFH-22K-5TA](#) [RCFH-2.2M-5TA](#) [RCFH-240K-5TA](#) [RCFH-24K-5TA](#) [RCFH-2-5TA](#) [RCFH-27-5TA](#) [RCFH-27K-5TA](#) [RCFH-2M-5TA](#) [RCFH-330-5TA](#) [RCFH-33-5TA](#) [RCFH-3.3M-5TA](#) [RCFH-360-5TA](#) [RCFH-360K-5TA](#) [RCFH-3.6M-5TA](#) [RCFH-39-5TA](#) [RCFH-39K-5TA](#) [RCFH-3.9M-5TA](#) [RCFH-430-5TA](#) [RCFH-47K-5TA](#) [RCFH-510K-5TA](#) [RCFH-51-5TA](#)