

THIS DRAWING IS UNPUBLISHED.

RELEASED FOR PUBLICATION

REVISIONS

© COPYRIGHT — TE Connectivity Ltd.

ALL RIGHTS RESERVED.

P	LTR	DESCRIPTION	DATE	DWN	APVD
	A	INITIAL DRAWN	04NOV2019	RV	MB

Electrical Characteristics

Contact Arrangement —

2 Form C (DPDT)

Contact Material —

Stationary —
Hardened silver alloy
Moveable —
Gold plated hardened silver alloy

Contact Resistance —

Before Life — 50 milliohms max.
(measured at 10 mA @ 6 Vdc)
After Life — 100 milliohms max.
(measured @ 2 A @ 28 Vdc)

Mechanical Life Expectancy —

50 million operations

Coil Voltage —

5 to 48 Vdc (HFW)
6 to 26.5 Vdc (HMB)
5 to 36 Vdc (HMS)

Coil Power — 1.4 watts max. @ 25°C

Duty Cycle — Continuous

Pick-up Voltage — Approximately

50% of nominal coil voltage

Pick-up Sensitivity @ 25°C —

145 to 260 mW (HFW)
325 mW (HMB)
100 to 125 mW (HMS)

Standard Coil Data

	Nom. Coil Voltage (Vdc)	Coil Resistance in Ohms ±10% @ 25°C	Pickup Voltage Vdc (Max.) @ 25°C	Pickup Voltage Vdc (Min.) @ 125°C	Drop-out Voltage Vdc (Min.) @ 25°C	Drop-out Voltage Vdc (Min.) @ -65°C	Nom. Coil Power (mW) @ 25°C	Max. Coil Voltage	Coil Desig.
HFW	5.0	27	2.7	3.8	0.29	0.21	926	6.0	L
	6.0	40	3.2	4.5	0.35	0.25	900	7.5	F
	12.0	160	6.4	9.0	0.7	0.5	900	15.0	G
	26.5	700	13.5	18.0	1.5	1.0	1003	32.0	K
HMB	6.0	40	3.6	4.8	0.35	0.25	900	7.5	F
	12.0	160	7.2	9.6	0.7	0.5	900	15.0	G
	26.5	700	15.0	20.0	1.5	1.0	1003	32.0	K
HMS	5.0	47	2.2	3.2	0.21	0.12	532	7.0	S001
	6.0	75	2.75	4.0	0.27	0.17	480	9.0	S002
	12.0	310	5.6	8.0	0.55	0.35	465	20.0	S003
	26.5	1,030	11.4	16.5	1.1	0.7	682	35.0	S004
	30.0	1,620	14.3	21.0	1.4	0.9	556	44.0	S005
	36.0	2,640	18.0	26.0	1.8	1.1	491	56.0	S006
Other	6-8	60	3.5	4.85	0.35	0.22	817	9.0	A
(avail. for HFW relays only)	12-15	320	6.8	9.42	0.68	0.44	570	21.0	B
	18.0	520	9.5	13.16	0.95	0.62	623	27.0	J
	26.5-32	1,250	14.0	19.4	1.5	0.98	684	42.0	D
	40.0	2,700	21.3	29.5	2.1	1.37	593	61.0	H
	48.0	3,500	25.5	35.3	2.5	1.63	658	70.0	E

Specifying a Part Number Example:

Type: HFW Terminals: 12 Mountings: 30 Coils: K Features: 00 (n/a HMS)

Contact Ratings

Contact Load	Type	Operations Min.
2 A @ 28 Vdc	Resistive	100,000
0.75 A @ 28 Vdc	Inductive (200mH)	100,000
0.1 A @ 115 Vac, 60 Hz & 400 Hz	Resistive	100,000
0.3 A @ 115 Vac, 60 Hz & 400 Hz	Resistive	100,000
0.1 A @ 28 Vdc	Intermediate	50,000
0.160 A @ 28 Vdc	Lamp	100,000
30 µA @ 50 mVdc	Low Level	1,000,000

RF Performance

Frequency (MHz)	RF Losses (dB)	VSWR	Isolation (dB)
100	0.1	1.17:1	40
500	0.3	1.19:1	28
1000	0.4	1.19:1	23

HFW Standard Half Size High Performance Relay

Qualified to MIL-R-39016/6

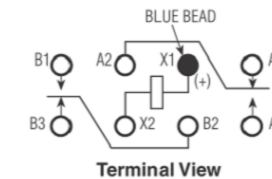
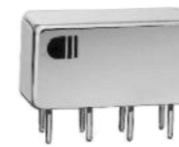

Terminal View

Product Facts

- Hermetically sealed
- Up to 2 amps switching
- High shock & vibration ratings
- Optional terminals & mounting styles
- Excellent RF switching

HMB Bifilar Half Size High Performance Relay

Qualified to MIL-R-39016/22

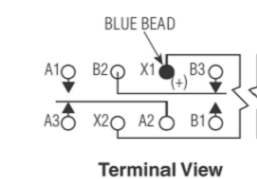

Terminal View

Product Facts

- Hermetically sealed
- Up to 2 amps switching
- High shock & vibration ratings
- Optional terminals & mounting styles
- Excellent RF switching

HMS Sensitive Half Size High Performance Relay

Qualified to MIL-R-39016/44

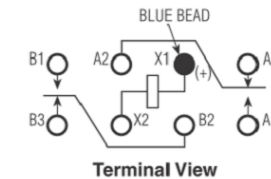
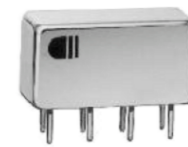

Terminal View

Product Facts

- Hermetically sealed
- Up to 2 amps switching
- High shock & vibration ratings
- Optional terminals & mounting styles
- Excellent RF switching

Operating Characteristics

Timing —

Operate Time —
4.0 ms max. (HFW)
5.0 ms max. (HMB)
6.0 ms max. (HMS)
Release Time —
4.0 ms max. (HFW)
5.0 ms max. (HMB/HMS)

Contact Bounce — 2.0 ms max.

Dielectric Withstanding Voltage —

Between Open Contacts —
500 Vrms 60 Hz
Between Adjacent Contacts —
1000 Vrms 60 Hz
Between Contacts & Coil —
1000 Vrms 60 Hz

Insulation Resistance —

10,000 megohms min. @ 500 Vdc

Environmental Characteristics

Temperature Range —

-65°C to +125°C

Weight — 0.46 oz. (13 gms max.)

Vibration Resistance —

HFW/HMB/HMS —
Standard — 20 G's, 10 to 2,000 Hz
HFW/HMB —
QPL — 30 G's, 10 to 3,000 Hz
HMS —
QPL — 20 G's, 10 to 2,500 Hz

Shock Resistance —

100 G's, 6 ±1 ms
50 G's, 11 ±1 ms (HMS)

QPL Approval —

MIL-R-39016/6 (HFW)
MIL-R-39016/22 (HMB)
MIL-R-39016/44 (HMS)

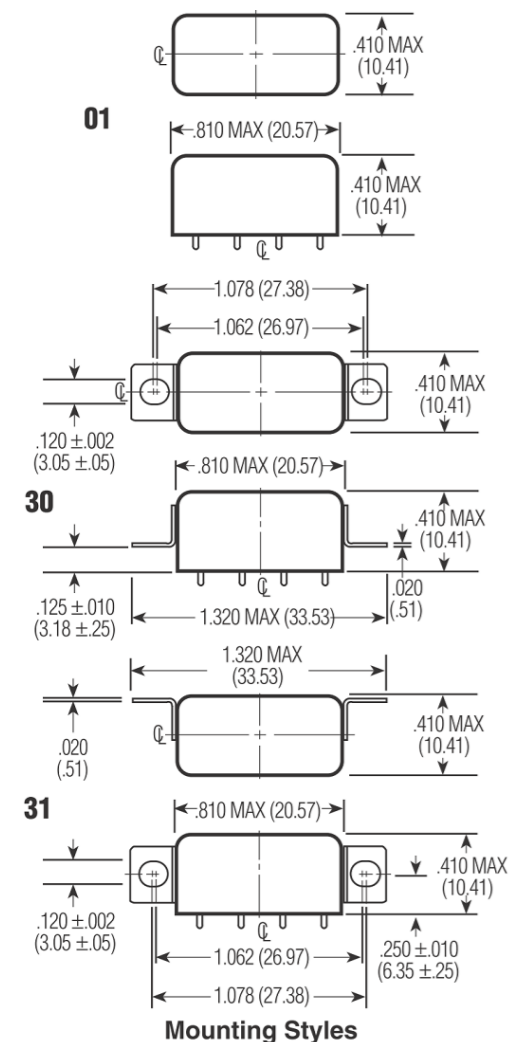

ALL DIMENSIONS ARE IN INCHES(MM)

THIS DRAWING IS A CONTROLLED DOCUMENT.

DIMENSIONS: INCHES

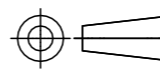

TOLERANCES UNLESS OTHERWISE SPECIFIED:

- 0 PLC ± -
- 1 PLC ± -
- 2 PLC ± -
- 3 PLC ± -
- 4 PLC ± -
- ANGLES ± -

MATERIAL

FINISH

DWN RV 04NOV2019

CHK RV 04NOV2019

APVD MB 04NOV2019

PRODUCT SPEC

APPLICATION SPEC

WEIGHT

CUSTOMER DRAWING

NAME

SIZE

CAGE CODE

DRAWING NO

RESTRICTED TO

SCALE

SHEET

REV



C-HFW-HMB/S-SERIES

A3 - C-HFW-HMB/S-SERIES

SCALE NTS

SHEET 1 OF 1

REV A

X-ON Electronics

Largest Supplier of Electrical and Electronic Components

Click to view similar products for [Industrial Relays](#) category:

Click to view products by [TE Connectivity](#) manufacturer:

Other Similar products are found below :

[6-1617801-8](#) [6-1618107-9](#) [7-1618273-3](#) [EV250-4A-02](#) [EV250-6A-01](#) [FCA-125-CX8](#) [FCA-325-159](#) [FCA-410-138](#) [8000-S3121](#) [8-1618273-6](#)
[8-1618393-1](#) [GCA63A220VAC60HZ](#) [GCA63A277VAC60HZ](#) [GCA63A600VAC60HZ](#) [1-1672275-3](#) [1-1833005-4](#) [H-16/S1](#) [A711Z](#) [H-8C](#)
[H-8/S11](#) [H-8/S68](#) [ACC530U20](#) [ACC730U30](#) [RF303ZM4-12](#) [DH18DA](#) [1423675-8](#) [AR4-15F13-C01](#) [AR7-41F11](#) [AVR907](#) [15732A200](#)
[B07B032AC1-0329](#) [B329](#) [B490A](#) [1618279-1](#) [BHR124Y](#) [1810DDB-SX](#) [N417](#) [P30C42A12D1-120](#) [2-1617748-6](#) [2-1618375-1](#) [2-1618396-6](#)
[2-1618398-1](#) [JMAPD-5XL](#) [JMGACD-5M](#) [JMGSC-5LW](#) [JMGSCD-5L](#) [PBO-18A1218](#) [PBO-40A3040](#) [K8DSPH1200480VAC](#) [KA-3C-12A](#)