

Mil-Spec Connectors & Accessories



DEUTSCH ECD

Defense / Aerospace Operations . . .

is the world's premier manufacturer of electrical interconnection devices for use in defense, aerospace, and commercial applications. Whether you need an interconnection device for a commercial or military aircraft, missile, tank, truck transmission or a host of other applications, Deutsch has the solution you're looking for.

Deutsch ECD Defense Aerospace Operations

5733 W. Whittier Ave., Hemet CA (USA) 92545
Phone 909/765-2200 • FAX 909/922-1544

MIL-C-83723 Series 1 & 3

Introduction

Reflecting developments in connector technology, MIL-C-83723 is a comprehensive Air Force specification covering circular, electrical connectors. Intermateable and intermountable with earlier connector types, these devices make it feasible to upgrade many existing electrical connecting systems.

Deutsch produces three basic lines of connectors which are qualified to MIL-C-83723. They feature a high degree of standardization in that contacts, tools, accessories, materials, finishes, assembly procedures, and basic design and performance characteristics are common for all three Deutsch lines. Contributing to a lower total installed cost and increased operational efficiency, this "systems" approach provides the connector user with such benefits as:

- Faster and simpler assembly and rework
- Greater standardization of tooling and procedures
- Reduced training and maintenance

First to qualify to MIL-C-83723, Deutsch connectors have been developed to withstand the extreme environmental conditions encountered by today's high-performance aircraft. They are particularly suited for applications such as: military and commercial aircraft, missiles and space vehicles and related ground support equipment.

Compatible with the military's Integrated Wire Termination System (IWTS) and Common Termination System (CTS), these Deutsch connectors enable the user to implement a commonality program on an evolutionary basis.

Specifically designed to eliminate failure modes characteristic of many previous designs, almost any connecting system can be upgraded. MIL-C-83723 series 1 and series 3 connectors will mate with many of the connector types that are presently in field use.

The series 1 connectors are intermateable and intermountable with existing MIL-C-26482 connector types.

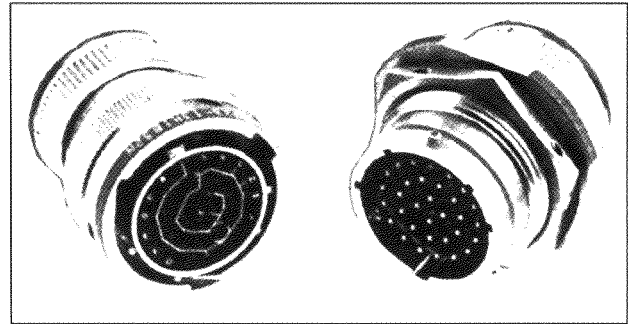

Series 1: Miniature connector with bayonet coupling mechanism. Intermateable and intermountable with MIL-C-26482 type connectors.

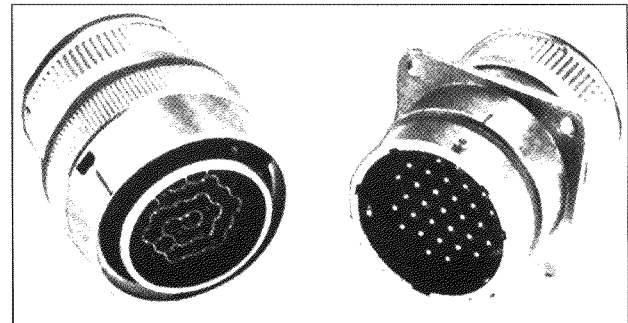

Series 3: Miniature connector with bayonet coupling mechanism. Intermateable and intermountable with MIL-C-26500 and MIL-C-38300 bayonet coupling type connectors.

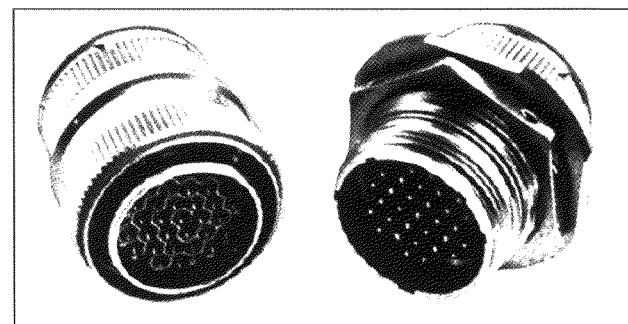

Series 3: Miniature connector with thread coupling mechanism. Intermateable and intermountable with MIL-C-26500 and MIL-C-38300 thread coupling type connectors.

This information is for reference only. Consult factory for envelope drawings, updated specifications, and additions to the product line.



The bayonet coupling version of series 3 will intermate and intermount with MIL-C-26500 and MIL-C-38300 bayonet type connectors.

Thread coupling connectors of series 3 are intermateable and intermountable with thread coupling versions of MIL-C-26500 and MIL-C-38300.

Change over with a minimum of cost and difficulty is assured by this intermateable and intermountable feature.

Deutsch uses only high-grade materials and finishes in the fabrication of these connectors.

Aluminum components are available in either nickel or black anodize plating. Resilient components are made of fluid resistant silicone which resists a permanent set and will not revert upon exposure to temperature extremes. The plastic components of the connector are made of high-strength, electrical grade material. All components are processed, manufactured, and quality-controlled in-house from raw material to finished product to assure exacting performance and high reliability.

Deutsch MIL-C-83723 connectors utilize crimp-type contacts that are inserted, released and removed from the rear of the connector. All that is needed is one, simple, fail-safe insertion/removal tool to install or remove wired contacts. Because the entire assembly process is performed at the connector rear, the possibility of damaging the critical interface of the connector is greatly reduced. This rear release feature also permits the removal or installation of any number of contacts without uncoupling the connector.

POSITIVE LOCKING CONTACTS

When the contact has been fully inserted into the insert cavity, the contact retention tines within the insert snap behind the shoulder of the contact. Once seated, contacts remain locked in place, resistant to shock and vibration. Retained between the dielectric insert and contact retention tines, contacts are safeguarded against failures due to contact pushout or pullout.

POSITIVE CONTACT ENGAGEMENT

The shell design, the relation of the inserts within the shell, the location of the contact retention device within the inserts, and the contacts themselves, are all made to precise, controlled tolerances to assure proper pin and socket engagement under worst case conditions.

MULTIPLE SEALS PROVIDE PROTECTION AGAINST CONTAMINATION

At the pin interface, contacts are surrounded by conical-shaped risers on the silicone blanket of the insert which fit into chamfered lead-ins of the socket insert upon connector mating. This "cork-in-bottle" sealing effect assures individual contact sealing at the connector interface.

In addition to individual contact sealing, these connectors incorporate additional protective seals to assure sealing against environmental extremes: interfacial compression seal, peripheral static/dynamic shell-to-shell seal, insert to shell seal, and redundant rear wire seals.

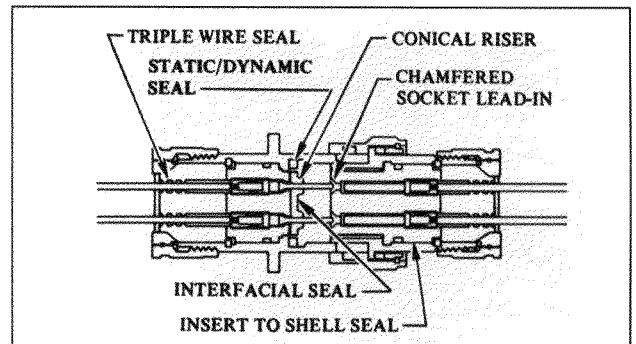

PROTECTION AGAINST BENT CONTACTS IS BUILT INTO THE DESIGN

Contacts are of one basic configuration with improved geometry for greater bend resistance. The closely-toleranced contact cavity of the plastic insert will not accept a contact that is bent beyond pre-established limits. The closed-down design also prevents unacceptable splaying of contacts when side-loads are applied to the wire bundle. In addition, if a pin contact should become slightly bent, the lead-in chamfer of the hard plastic socket insert acts as a funnel, straightening the pin and guiding it into the socket for proper engagement.

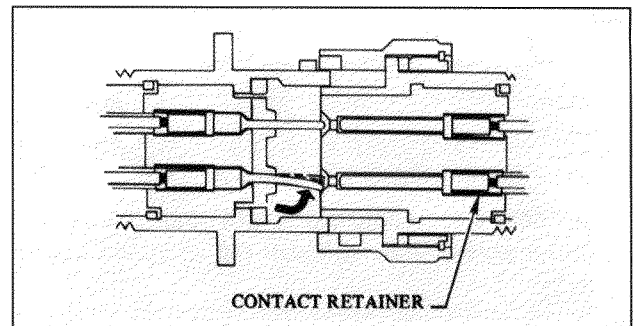

This information is for reference only. Consult factory for envelope drawings, updated specifications, and additions to the product line.



General Specifications

MIL-C-83723 Series 1 & 3

Dielectric withstanding voltage (test voltage):

At sea level: 1500 volts AC (RMS)

Contact spacing (min. nominal):

20 130 center to center
16 168 center to center
12 230 center to center

Current rating:

20 7.5 amps
16 13 amps
12 23 amps

Silicone insert:

Front and rear silicone insert are devoid of all organic matter.

Corrosion:

Meets MIL-STD 202E, Method 101, Condition "B"

Contact millivolt drop:

20 15 millivolts at 7.5 amps
16 21 millivolts at 20 amps
12 22 millivolts at 35 amps

Vibration:

Maintains continuity and exhibits no mechanical or physical damage after a total of 12 hours vibration (4 hours in each of three mutually perpendicular axes) when subjected to .06" D.A. or 20 G's from 10 to 2000 to 12 Hz. 50% of vibration time at ambient temperature, 25% of vibration time at -55°C and 25% of vibration time at +200°C.

Physical shock:

No unlocking, unmating or other unsatisfactory result after 100 G's in each of three mutually perpendicular planes.

Dielectric strength:

500 volts per mil, minimum on a .030" thick test specimen.

Crimp retention:

Meets requirements of MIL-C-83723.

Moisture resistance:

Insulation resistance in excess of 100 megohms after procedure in MIL-STD-202E, method 106.

Temperature:

Operative at temperatures from -55°C to +200°C.

Contact retention:

Contacts withstand a minimum load of:

20 lbs. for size 20
25 lbs. for size 16
30 lbs. for size 12

In either direction, contact displacement less than .012"

Usable wire size:

20 contacts — receive conductor AWG 20 through 24.
Rear insert will seal on smooth insulation form .040" to .083" O.D.

16 contacts — receive conductor AWG 16 through 20.
Rear insert will seal on smooth insulation form .053" to .103" O.D.

12 contacts — receive conductor AWG 12 through 14.
Rear insert will seal on smooth insulation form .097" to .158" O.D.

Insulation resistance:

5000 megohms minimum at 25°C.

Dielectric withstanding voltage (test voltage)

altitude:

Wired, assembled, unmated connectors will withstand:

500 VAC (RMS) at 50,000 ft.

375 VAC (RMS) at 70,000 ft.

200 VAC (RMS) at 110,000 ft.

Durability:

No electrical or mechanical defects after 500 cycles of engagement and disengagement per MIL-C-83723.

Altitude immersion:

Meets requirements of MIL-C-83723.

Air leakage:

Less than 0.01 micron cu/ft/hr at 14.7 psi diff. per MIL-C-83723



Series 1 Insert Alternate Clocking Position

SIZE AND ARRANGEMENT	ALTERNATE POSITIONS				
	N	W	X	Y	Z
8-3	0°	60°	210°		
8-4	0°	45°			
8-33	0°	90°			
8-98	0°	90°			
10-6	0°	90°			
12-3	0°			180°	
12-8	0°	90°	112°	203°	292°
12-10	0°	60°	155°	270°	295°
14-4	0°	45°			
14-5	0°	40°	92°	184°	273°
14-12	0°	43°	90°		
14-15	0°	17°	110°	155°	234°
14-18	0°	15°	90°	180°	270°
14-19	0°	30°	165°	315°	
16-8	0°	54°	152°	180°	331°
16-23	0°	158°	270°		
16-26	0°	60°		275°	338°
18-8	0°	180°			
18-11	0°	62°	119°	241°	340°
18-30	0°	180°	193°	285°	350°
18-32	0°	85°	138°	222°	265°
20-16	0°	238°	318°	333°	347°
20-39	0°	63°	144°	252°	333°
20-41	0°	45°	126°	225°	
22-12	0°				
22-21	0°	16°	135°	175°	349°
22-32	0°	72°	145°	215°	288°
22-41	0°	39°	135°	264°	
22-55	0°	30°	142°	226°	314°
24-19	0°	30°	165°	315°	
24-31	0°	90°	225°	255°	
24-61	0°	90°	180°	270°	324°

▼ Indicates \mathcal{C} of Shell

The symbol α° indicates insert rotation in degrees.

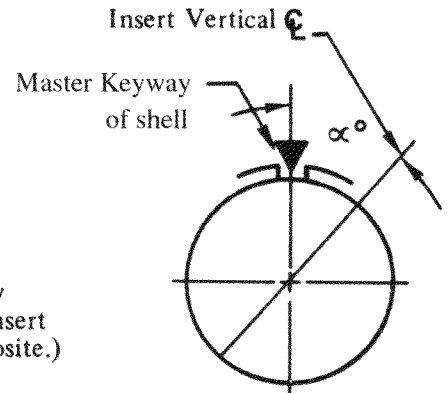

NOTES:

1. For alternate polarizing positions, the connector insert is rotated in respect to the shell.
2. In "Normal Position" (position "N") the insert vertical centerline coincides with the centerline of the master keyway of the shell.
3. In "Alternate Positions" (positions "W", "X", "Y", and "Z") the pin insert is rotated α degrees clockwise relative to \mathcal{C} of the master Keyway of shell.
4. In "Alternate Positions" (positions "W", "X", "Y", and "Z") the socket insert is rotated α degrees counterclockwise relative to the \mathcal{C} of the master keyway of shell.

This information is for reference only. Consult factory for envelope drawings, updated specifications, and additions to the product line.



Series 3 Shell Alternate Keying Position

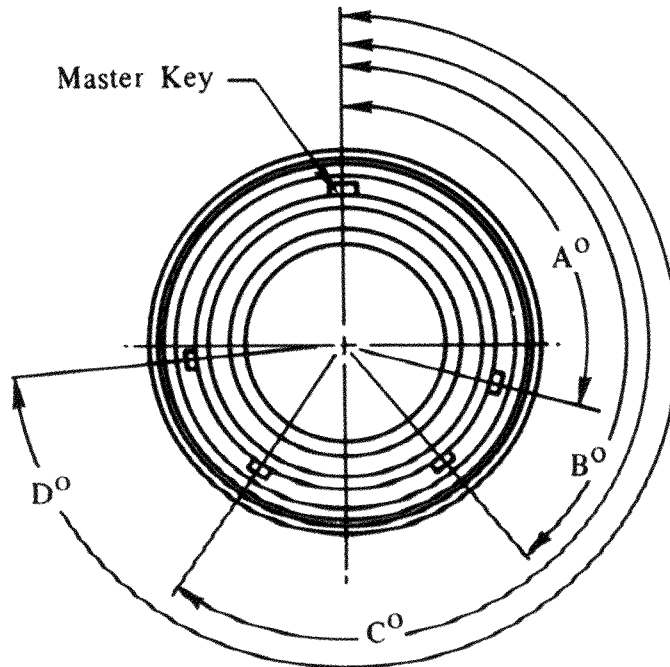

Plug Face shown
(Keyways in Receptacle
Shell are opposite.)

NOTES:

1. In the "Alternate Keying Position" (positions 6, 7, 8, 9, & 10), the keys are positioned as indicated in the chart below with reference to master key.
2. When the alternate shell keying positions are used, the applicable insert is always in the normal position.

KEY/KEYWAY LOCATIONS

KEYING POSITION	SIZE 8				SIZE 10				SIZE 12 THRU 24			
	A°	B°	C°	D°	A°	B°	C°	D°	A°	B°	C°	D°
NORMAL	105	140	215	265	105	140	215	265	105	140	215	265
6	102	132	248	320	102	132	248	320	18	149	192	259
7	80	118	230	312	80	118	230	312	92	152	222	342
8	35	140	205	275	35	140	205	275	84	152	204	334
9	64	155	234	304	64	155	234	304	24	135	199	240
10					25	115	220	270	98	152	268	338

This information is for reference only. Consult factory for envelope drawings, updated specifications, and additions to the product line.



MIL-C-83723 Series 1 Bayonet Coupling Connectors

SHELL STYLES

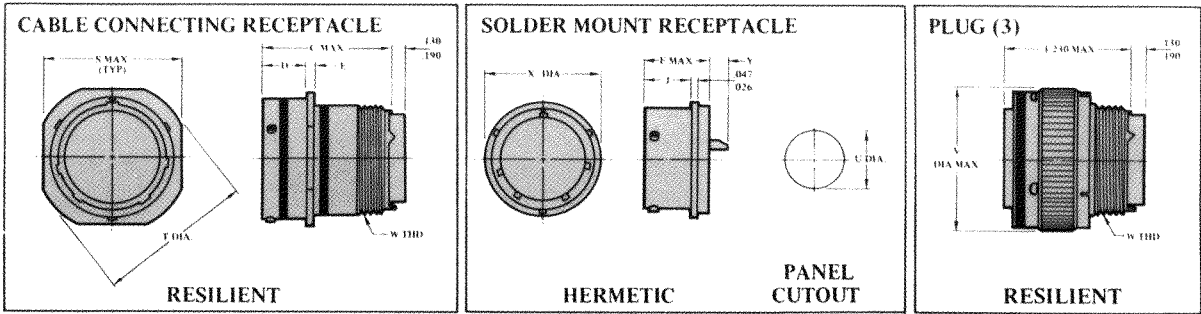
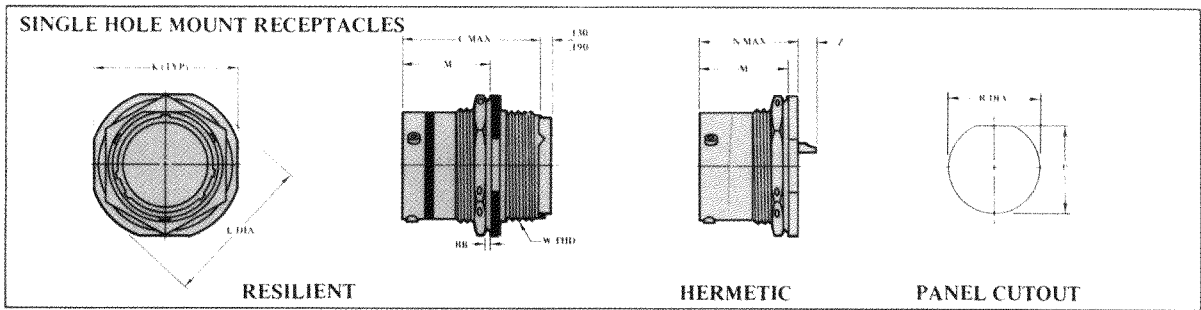
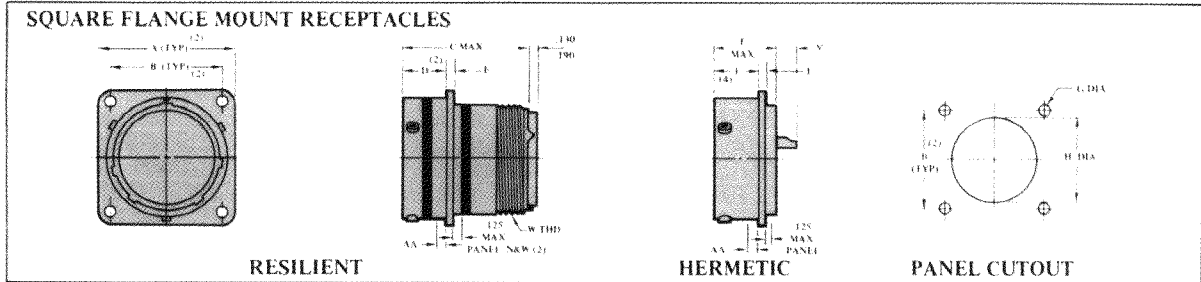

SIZE	AA MAX PANEL		BB MAX PANEL	(2) A MAX		(2) B ±.005		C MAX	(2) D		E	F MAX	G ±.005	(6) H	(4) J
	N	W		N	W	N	W		N	W					
8	.087	.118	.187	.828	1.065	.594	.734	1.215	.462 .431	.493 .462	.078 .046	.801	.120	.573 .578	.598 .578
10	.087	.118	.187	.954	1.141	.719	.812	1.215	.462 .431	.493 .462	.078 .046	.801	.120	.690 .680	.598 .578
12	.087	.118	.187	1.047	1.266	.812	.938	1.215	.462 .431	.493 .462	.078 .046	.801	.120	.869 .859	.598 .578
14	.087	.118	.187	1.141	1.360	.906	1.031	1.215	.462 .431	.493 .462	.078 .046	.801	.120	.994 .984	.598 .578
16	.087	.118	.187	1.234	1.453	.969	1.125	1.215	.462 .431	.493 .462	.078 .046	.801	.120	1.118 1.108	.598 .578
18	.087	.118	.187	1.328	1.532	1.062	1.203	1.215	.462 .431	.493 .462	.078 .046	.801	.120	1.243 1.233	.598 .578
20	.212	.212	.230	1.453	1.688	1.156	1.297	1.275	.587 .556	.587 .556	.110 .078	.863	.120	1.368 1.358	.660 .640
22	.212	.212	.250	1.578	1.766	1.250	1.375	1.275	.587 .556	.587 .556	.110 .078	.895	.120	1.493 1.483	.660 .640
24	.212	.212	.219	1.703	1.891	1.375	1.500	1.275	.620 .589	.620 .589	.110 .078	.895	.147	1.620 1.610	.660 .640

- NOTES: 1. All Dimensions in inches
 2. N = Narrow Flange W = Wide Flange
 3. Plugs with RFI Fingers Have Same Dimensional Control as Shown
 4. "J" Dimension Same for Both Narrow and Wide Square Flange Connector
 5. See Page 12 for Backshell Requirements.
 6. For Front or Rear Mounting.

This information is for reference only. Consult factory for envelope drawings, updated specifications, and additions to the product line.



Insert Arrangements

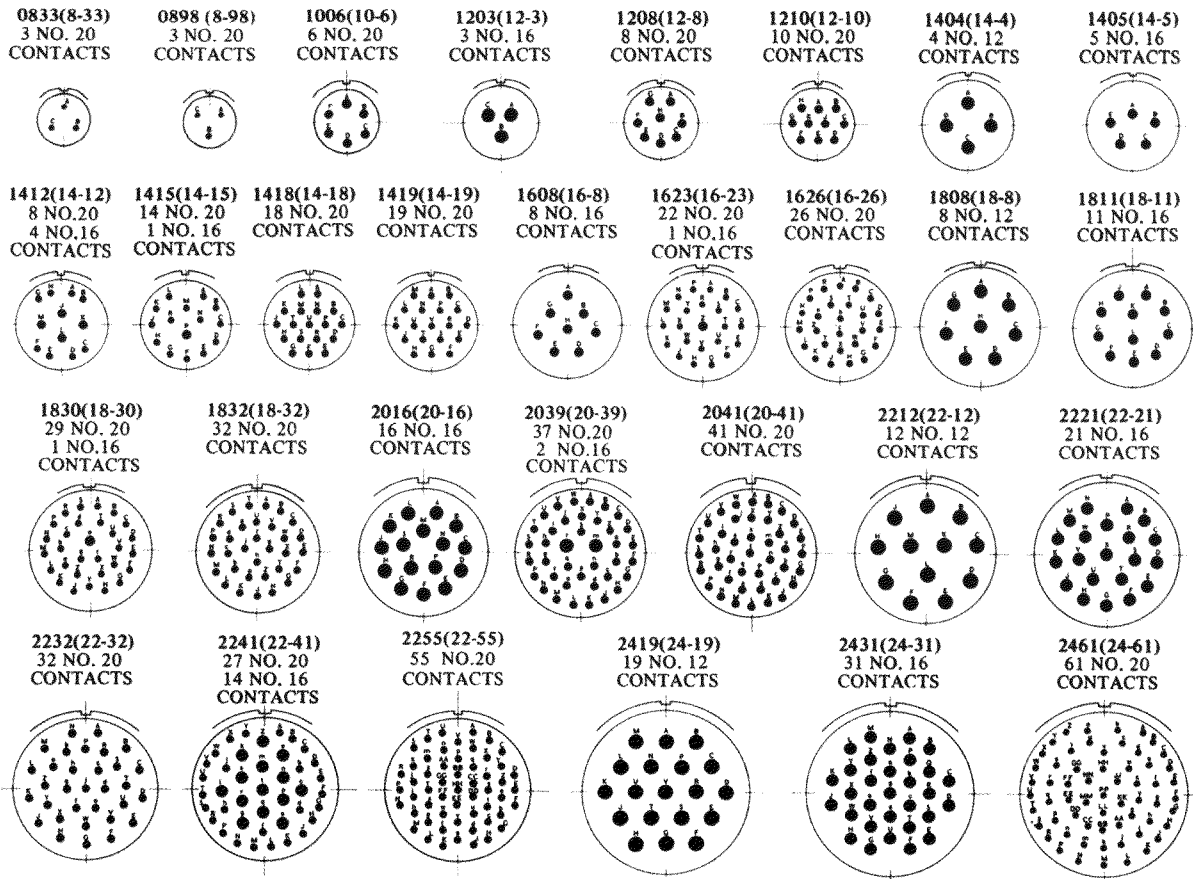

- NOTES: 1. For Other Insert Arrangements Consult Factory.
 2. Military Identification of Insert Arrangement Utilizes 4 Digits as Shown.
 3. Deutsch Identification of Insert Arrangement is Shown in Parentheses.
 4. The 8-3 and 8-4 Arrangements are Available only as Pre-wired Connectors (if consult Factory).
 5. Cavity Identification Shown here for Pin Insert Face (Socket Opposite) and is for Reference Only.
 6. Actual Insert Marking Shall be in Accordance With Mil-C-83723.

K	L	M	N MAX	P \pm .005	R \pm .005	S MAX	T	U \pm .005	V MAX	W THREAD-2A	X	Y		Z	
												CONTACT SIZE		CONTACT SIZE	
												20	16 & 12	20	16 & 12
.954 .923	1.078 1.047	.707 .691	.820	.536	.572	.828	.958 .918	.570	.782	1/2-20 UNF	.635 .615	.178 .118	.248 .188	.134 .074	.204 .144
1.078 1.047	1.203 1.172	.707 .691	.820	.661	.697	.954	1.082 1.042	.680	.926	5/8-24 UNF	.760 .740	.178 .118	.248 .188	.134 .074	.204 .144
1.266 1.235	1.391 1.360	.707 .691	.820	.824	.895	1.047	1.176 1.136	.789	1.043	3/4-20 UNF	.854 .834	.178 .118	.248 .188	.134 .074	.204 .144
1.391 1.360	1.516 1.485	.707 .691	.820	.948	1.010	1.141	1.270 1.230	.914	1.183	7/8-20 UNF	.979 .959	.178 .118	.248 .188	.134 .074	.204 .144
1.516 1.485	1.641 1.610	.707 .691	.820	1.072	1.135	1.234	1.364 1.324	1.039	1.305	1-20 UNF	1.104 1.084	.178 .118	.248 .188	.134 .074	.204 .144
1.641 1.610	1.766 1.735	.707 .691	.820	1.197	1.260	1.328	1.458 1.418	1.164	1.391	1 1/16-18 UNF	1.238 1.208	.178 .118	.248 .188	.134 .074	.204 .144
1.828 1.797	1.954 1.923	.772 .754	.920	1.322	1.385	1.453	1.582 1.542	1.258	1.531	1 3/16-18 UNF	1.322 1.302	.178 .118	.248 .188	.099 .039	.169 .109
1.954 1.923	2.078 2.047	.772 .754	.920	1.447	1.510	1.578	1.708 1.668	1.383	1.656	1 5/16-18 UNF	1.448 1.438	.146 .086	.216 .156	.099 .039	.169 .109
2.078 2.047	2.203 2.172	.772 .754	.951	1.572	1.635	1.703	1.832 1.792	1.508	1.777	1 7/16-18 UNF	1.574 1.554	.146 .086	.216 .156	.099 .039	.169 .109

This information is for reference only. Consult factory for envelope drawings, updated specifications, and additions to the product line.



Contact & Tooling Information

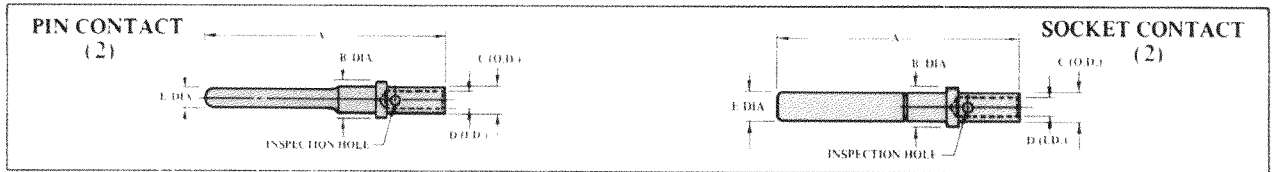

CONTACTS (1)					SEALING PLUG		INSERTION/REMOVAL TOOL (3)		WIRE STRIP LENGTH					
DEUTSCH PART NO.	MILITARY PART NO.	STYLE	COLOR CODE (4)	SIZE	MAX. A	MAX. B	MAX. C	MIN. D		MAX. E	DEUTSCH PART NO.	MILITARY PART NO.	DEUTSCH PART NO.	MILITARY PART NO.
0641-1-2031	M39029/4-110	PIN	RED	20	.720	.103	.078	.048	.041	M527488-20-2	M527488-20-2	M15570-20	M83723-31-20	5/32" to 7/32"
100503	M39029/5-115	SOC	RED	20	.656	.103	.078	.048	.078	M527488-16-2	M527488-16-2	M15570-16	M83723-31-16	1/4" to 5/16"
0641-2-1631	M39029/4-111	PIN	BLUE	16	.821	.133	.103	.066	.0635	M527488-12-2	M527488-12-2	M15570-12	M83723-31-12	1/4" to 5/16"
100504	M39029/5-116	SOC	BLUE	16	.759	.133	.103	.066	.113					
0641-3-1231	M39029/4-113	PIN	YELLOW	12	.821	.190	.151	.098	.095					
100505	M39029/5-118	SOC	YELLOW	12	.759	.190	.151	.098	.161					

NOTES: (1) Use Crimp Tool M22520/1-01 Positioner Part No. M22520/1-02.
 (2) Size 8 Power Contacts, Coax Contacts, and Size 12 Shielded Contacts are Available (Consult Factory).
 (3) A Tool for Removal of Unwired Contacts is Available Under Part No. M15571.
 (4) Crimp Barrel is Color Coded per Tabulation, Consult Factory for Correct Code since two color bands are used. One denoting Contact Size, the second denoting crimp barrel size.

Rear Accessories (4)

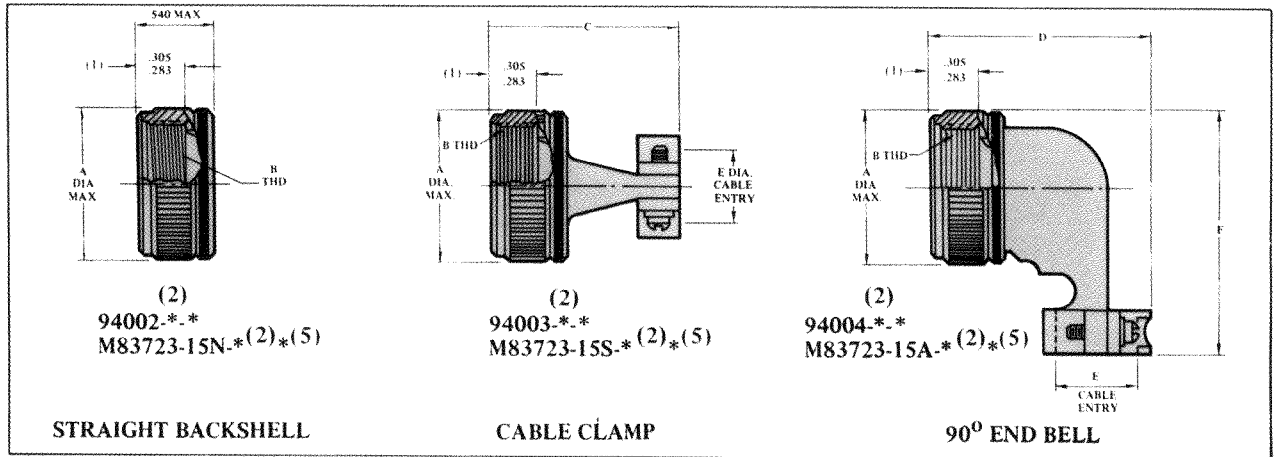

SIZE	DEUTSCH PART NUMBER FOR CLASS A (3)	DEUTSCH PART NUMBER FOR CLASS R (3)	MILITARY PART NO. (3)(5)	A MAX	B THREAD-2B	C ±.031	D MAX	E ±.016	F MAX
8	9400*-8	9400*-8-3014	M83723-15*8*	.617	1/2-20 UNF	.859	1.069	.188	1.139
10	9400*-10A	9400*-10A-3014	M83723-15*-10*	.734	5/8-24 UNEF	.859	1.163	.270	1.247
12	9400*-12	9400*-12-3014	M83723-15*-12*	.858	3/4-20 UNEF	.859	1.298	.400	1.379
14	9400*-14	9400*-14-3014	M83723-15*-14*	.984	7/8-20 UNEF	1.093	1.388	.460	1.502
16	9400*-16	9400*-16-3014	M83723-15*-16*	1.112	1-20 UNEF	1.093	1.523	.610	1.626
18	9400*-18	9400*-18-3014	M83723-15*-18*	1.218	1 1/16-18 UNEF	1.093	1.622	.690	1.739
20	9400*-20	9400*-20-3014	M83723-15*-20*	1.345	1 3/16-18 UNEF	1.093	1.755	.815	1.863
22	9400*-22	9400*-22-3014	M83723-15*-22*	1.468	1 5/16-18 UNEF	1.093	1.878	.940	1.994
24	9400*-24	9400*-24-3014	M83723-15*-24*	1.593	1 7/16-18 UNEF	1.093	2.000	1.065	2.117

(1) Dimension From Front of Coupling Nut to Front of Teeth. (2)* Denotes Shell Size. (3)* Denotes Backshell Style. (4). Resilient Connectors Must Have Backshells In Order to Meet Moisture Sealing Requirements. (5)* Denotes Class.

This information is for reference only. Consult factory for envelope drawings, updated specifications, and additions to the product line.



Part Series 1 Bayonet Coupling

SERIES 1 BAYONET COUPLING

Description	Contact Style	Military Part Number Class (A) Finish	DEUTSCH Part Number Class (A) Finish	Military Part Number Class (R) Finish
Square Flange Receptacle	Socket	M83723-01A**N	AFD50-*SN-6116	M83723-01R**N
	Pin	M83723-02A**N	AFD50-*PN-6116	M83723-02R**N
Wide Sq. Flange Receptacle	Socket	M83723-03A**N	AFD58-*SN-6116	M83723-03R**N
	Pin	M83723-04A**N	AFD58-*PN-6116	M83723-04R**N
Single Hole Receptacle	Socket	M83723-05A**N	AFD54-*SN-6116	M83723-05R**N
	Pin	M83723-06A**N	AFD54-*PN-6116	M83723-06R**N
Cable Connecting Receptacle	Socket	M83723-07A**N	AFD51-*SN-6116	M83723-07R**N
	Pin	M83723-08A**N	AFD51-*PN-6116	M83723-08R**N
Square Flange, Hermetic	Pin	N/A	N/A	M83723-09H**N
Wide Square Flange, Hermetic	Pin	N/A	N/A	M83723-10H**N
Solder Flange, Hermetic	Pin	N/A	N/A	M83723-11H**N
Single Hole, Hermetic	Pin	N/A	N/A	M83723-12H**N
Plug	Socket	M83723-13A**N	AFD56-*SN-6116	M83723-13H**N
	Pin	M83723-14A**N	AFD56-*PN-6116	M83723-14H**N
Pre-Wired Plug	Socket	M83723-37A**N	88009-8-*S-6116	M83723-37R**N
	Pin	M83723-36A**N	88009-8-*P-6116	M83723-36R**N
Pre-Wired Narrow Square Flange Receptacle	Socket	M83723-39A**N	88008-8-*S-6116	M83723-39R**N
	Pin	M83723-38A**N	88008-8-*P-6116	M83723-38R**N
Pre-Wired Wide Square Flange Receptacle	Socket	M83723-41A**N	88019-8-*S-6116	M83723-41R**N
	Pin	M83723-40A**N	88019-8-*P-6116	M83723-40R**N

SERIES 3 BAYONET COUPLING

Description	Contact Style	Military Part Number Class (A) Finish	DEUTSCH Part Number Class (A) Finish	Military Part Number Class (R) Finish
Square Flange Receptacle	Socket	M83723-71A**N	DL60R*SN-6116	M83723-71R**N
	Pin	M83723-72A**N	DL60R*PN-6116	M83723-72R**N
Single Hole Receptacle	Socket	M83723-73A**N	DL64R*SN-6116	M83723-73R**N
	Pin	M83723-74A**N	DL64R*PN-6116	M83723-74R**N
Plug	Socket	M83723-75A**N	DL66R*SN-6116	M83723-75R**N
	Pin	M83723-76A**N	DL66R*PN-6116	M83723-76R**N
Plug, R.F.I. Grounding	Socket	N/A	N/A	M83723-77R**N
	Pin	N/A	N/A	M83723-78R**N
Square Flange, Hermetic	Pin	N/A	N/A	M83723-79R**N
Solder Flange, Hermetic	Pin	N/A	N/A	M83723-80R**N
Single Hole, Hermetic	Pin	N/A	N/A	M83723-81R**N
Solder Mount Receptacle with Extended Pins, Hermetic	Pin	N/A	N/A	M83723-93R**N
Single Hole Mount Receptacle with Extended Pins, Hermetic	Pin	N/A	N/A	M83723-94R**N

SERIES 3 THREAD COUPLING

Description	Contact Style	Military Part Number Class (A) Finish	DEUTSCH Part Number Class (A) Finish	Military Part Number Class (R) Finish
Square Flange Receptacle	Socket	M83723-82A**N	DBA30*SN-6116	M83723-82R**N
	Pin	M83723-83A**N	DBA30*PN-6116	M83723-83R**N
Single Hole Receptacle	Socket	M83723-84A**N	DBA34*SN-6116	M83723-84R**N
	Pin	M83723-85A**N	DBA34*PN-6116	M83723-85R**N
Plug	Socket	M83723-86A**N	DBA36*SN-6116	M83723-86R**N
	Pin	M83723-87A**N	DBA36*PN-6116	M83723-87R**N
Square Flange, Hermetic	Pin	N/A	N/A	M83723-88H**N
Single Hole, Hermetic	Pin	N/A	N/A	M83723-89H**N
Solder Flange, Hermetic	Pin	N/A	N/A	M83723-90H**N

NOTE: "N" IN PART NUMBER DENOTES NORMAL POLARIZATION

This information is for reference only. Consult factory for envelope drawings, updated specifications, and additions to the product line.



Ordering information

DEUTSCH Part Number Class (A) Finish	Military Part Number Class (W) Finish	DEUTSCH Part Number Class (W) Finish
	M83723-01W**N	AFD50-*. *SN-6117
AFD50-*. *PN-1A	M83723-02W**N	AFD50-*. *PN-6117
AFD58-*. *SN-1A	M83723-03W**N	AFD58-*. *SN-6117
AFD58-*. *PN-1A	M83723-04W**N	AFD58-*. *PN-6117
AFD54-*. *SN-1A	M83723-05W**N	AFD54-*. *SN-6117
AFD54-*. *PN-1A	M83723-06W**N	AFD54-*. *PN-6117
AFD51-*. *SN-1A	M83723-07W**N	AFD51-*. *SN-6117
AFD51-*. *PN-1A	M83723-08W**N	AFD51-*. *PN-6117
DBC50H-*. *PN	N/A	N/A
DBC58H-*. *PN	N/A	N/A
DBC53H-*. *PN	N/A	N/A
DBC54H-*. *PN	N/A	N/A
AFD56-*. *SN-1A	M83723-13W**N	AFD56-*. *SN-6117
AFD56-*. *PN-1A	M83723-14W**N	AFD56-*. *PN-6117
88009-8- *S-1A	M83723-37W**N	88009-8- *S-6117
88009-8- *P-1A	M83723-36W**N	88009-8- *P-6117
88008-8- *S-1A	M83723-39W**N	88008-8- *S-6117
88008-8- *P-1A	M83723-38W**N	88008-8- *P-6117
88019-8- *S-1A	M83723-41W**N	88019-8- *S-6117
88019-8- *P-1A	M83723-40W**N	88019-8- *P-6117

DEUTSCH Part Number Class (R) Finish	Military Part Number Class (W) Finish	DEUTSCH Part Number Class (W) Finish
DL60R-*. *SN-6106	M83723-71W**N	DL60R-*. *SN-6117
DL60R-*. *PN-6106	M83723-72W**N	DL60R-*. *PN-6117
DL64R-*. *SN-6106	M83723-73W**N	DL64R-*. *SN-6117
DL64R-*. *PN-6106	M83723-74W**N	DL64R-*. *PN-6117
DL66R-*. *SN-6106	M83723-75W**N	DL66R-*. *SN-6117
DL66R-*. *PN-6106	M83723-76W**N	DL66R-*. *PN-6117
DL68G-*. *SN-6106	M83723-77W**N	DL68G-*. *SN-6117
DL68R-*. *PN-6106	M83723-78W**N	DL68G-*. *PN-6117
DL60H-*. *PN	N/A	N/A
DL61H-*. *PN	N/A	N/A
DL64H-*. *PN	N/A	N/A
DL61H-*. *PN-830	N/A	N/A
DL64H-*. *PN-829	N/A	N/A

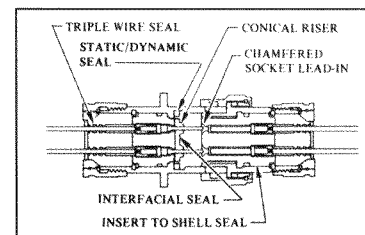

DEUTSCH Part Number Class (W) Finish	Military Part Number Class (W) Finish	DEUTSCH Part Number Class (W) Finish
DBA30-*. *SN-6106	M83723-82W**N	DBA30-*. *SN-6117
DBA30-*. *PN-6106	M83723-83W**N	DBA30-*. *PN-6117
DBA34-*. *SN-6106	M83723-84W**N	DBA34-*. *SN-6117
DBA34-*. *PN-6106	M83723-85W**N	DBA34-*. *PN-6117
DBA36-*. *SN-6106	M83723-86W**N	DBA36-*. *SN-6117
DBA36-*. *PN-6106	M83723-87W**N	DBA36-*. *PN-6117
DBC30H-*. *PN	N/A	N/A
DBC34H-*. *PN	N/A	N/A
DBC33H-*. *PN	N/A	N/A

Military Part Numbering System

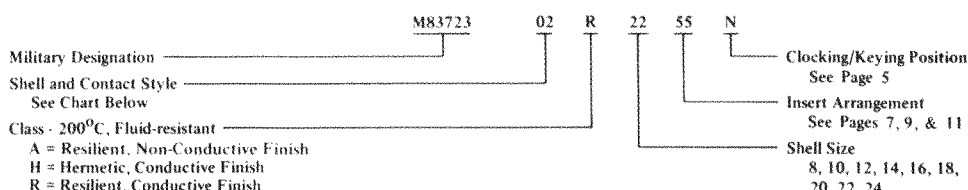

X-ON Electronics

Largest Supplier of Electrical and Electronic Components

Click to view similar products for [Circular MIL Spec Connector](#) category:

Click to view products by [TE Connectivity](#) manufacturer:

Other Similar products are found below :

[89075GULPR](#) [0025-262-542](#) [58-584653-12P](#) [0134-202-1200](#) [0134-207-1206](#) [0134-207-1800](#) [0134-207-2207](#) [0134-213-0806](#) [0134-213-1007](#)
[0134-213-1009](#) [0134-213-1200](#) [0134-213-1208](#) [0134-213-1800](#) [0134-213-2209](#) [0025-258-000](#) [015-9516-002](#) [5M30-61](#) [60-042217-10P](#) [60-042722-19P](#) [0114-201-1278](#) [024251-0015](#) [602GB06EG1832SN](#) [602GB06EG24-61SN](#) [0134-201-1207](#) [0134-201-1806](#) [0134-201-2006](#) [0134-201-2007](#) [0134-201-2010](#) [0134-202-1400](#) [0134-207-0809](#) [0134-207-1208](#) [0134-207-2009](#) [0134-213-0800](#) [0134-213-1006](#) [0134-213-1008](#)
[6104-209-1702](#) [61-168211-04P](#) [6131-202-19149P](#) [6131-204-21149P](#) [6131-207-13149P](#) [6131-208-13149P](#) [6131-209-17149P](#) [6131-210-11149P](#) [6131-211-19149P](#) [6131-216-19149P](#) [6131-220-25149P](#) [6131-259-11149P](#) [6131-259-21149P](#) [6131-259-23149P](#) [6131-263-19149P](#)