

TERMINAL, SOLIS R 4 3/8 ✓ ACTIVE

SOLISTRAND

TE Part # 31812

TE Internal #: 31812

Mil-Spec: [MS20659-112]

[View on TE.com >](#)



Terminals & Splices > Rings & Spades



Terminal & Splice Type: **Ring Tongue**

Wire Size: **33100 – 52600 CMA**

Stud Size: **3/8**

Features

Product Type Features

Shape Description	RING-049
Stud Size	3/8
Barrel Type	Closed Barrel
Sealable	No
Insulated	No
Wire/Cable Type	Regular Wire

Configuration Features

Number of Holes	1
Terminal Angle	Straight

Body Features

Inspection Slot	No
Weight per Piece	10.933 g
Plating Material	Copper, Tin

Contact Features

Military Part Class	Class II
Terminal & Splice Type	Ring Tongue
Terminal Orientation	Offset

Mechanical Attachment

Wire Insulation Support	Without
-------------------------	---------

Dimensions



Wire Size	33100 – 52600 CMA
Stud Diameter	9.53 mm, 9.91 mm[.39 in]
Tongue Thickness	1.78 mm[.07 in]
Overall Length	33.63 mm[1.324 in]
Barrel Inside Diameter	7.11 mm[.28 in]

Usage Conditions

Operating Temperature Range	170 °C[338 °F]
-----------------------------	----------------

Operation/Application

Heavy Duty	No
------------	----

Industry Standards

Government Qualified	Yes
----------------------	-----

Packaging Features

Packaging Quantity	100
Packaging Method	Box

Product Compliance

[For compliance documentation, visit the product page on TE.com>](#)

EU RoHS Directive 2011/65/EU	Compliant
EU ELV Directive 2000/53/EC	Compliant
China RoHS 2 Directive MIIT Order No 32, 2016	No Restricted Materials Above Threshold
EU REACH Regulation (EC) No. 1907/2006	Current ECHA Candidate List: JAN 2019 (197) Candidate List Declared Against: JAN 2019 (197)
Halogen Content	Low Halogen - Br, Cl, F, I < 900 ppm per homogenous material. Also BFR/CFR/PVC Free
Solder Process Capability	Not applicable for solder process capability

Product Compliance Disclaimer

This information is provided based on reasonable inquiry of our suppliers and represents our current actual knowledge based on the information they provided. This information is subject to change. The part numbers that TE has identified as EU RoHS compliant have a maximum concentration of 0.1% by weight in homogenous materials for lead, hexavalent chromium, mercury, PBB, PBDE, DBP, BBP, DEHP, DIBP, and 0.01% for cadmium, or qualify for an exemption to these limits as defined in the Annexes of Directive 2011/65/EU (RoHS2). Finished electrical and electronic equipment products will be CE marked as required by Directive 2011/65/EU. Components may not be CE marked. Additionally, the part numbers that TE has identified as EU ELV compliant have a maximum concentration of 0.1% by weight in homogenous materials for lead, hexavalent chromium, and mercury, and 0.01% for cadmium, or qualify for an exemption to these limits as defined in the Annexes of Directive 2000/53/EC (ELV). Regarding the REACH Regulations, TE's information on SVHC in

articles for this part number is still based on the European Chemical Agency (ECHA) 'Guidance on requirements for substances in articles'(Version: 2, April 2011), applying the 0.1% weight on weight concentration threshold at the finished product level. TE is aware of the European Court of Justice ruling of September 10th, 2015 also known as O5A (Once An Article Always An Article) stating that, in case of 'complex object', the threshold for a SVHC must be applied to both the product as a whole and simultaneously to each of the articles forming part of its composition. TE has evaluated this ruling based on the new ECHA "Guidance on requirements for substances in articles" (June 2017, version 4.0) and will be updating its statements accordingly.

Compatible Parts

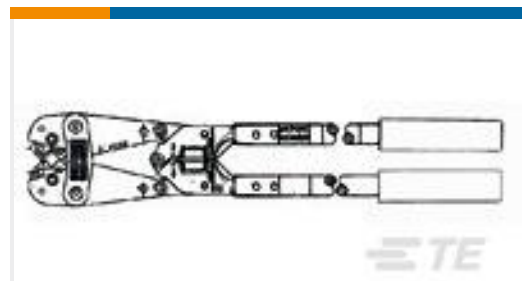

TE Part # 600850
 ROTO-CRIMP TOOL (ASI)



TE Part # 48127
 INDENTER INSERT, SOLIS #6

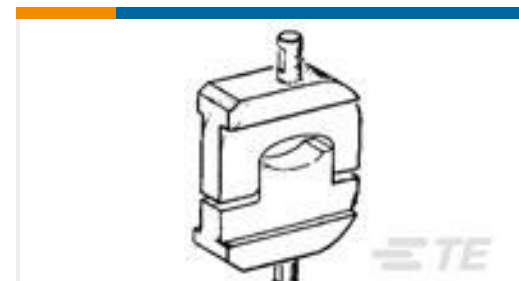

TE Part # 69218
 DIE SOLIS 69099 #4



TE Part # 1901000-2
 NEST #4



TE Part # 601075
 BANTAM ROTA-CRIMP TOOL



TE Part # 1490414-2
 INDENTER,U-DIE, SOLISTRAND #6-2

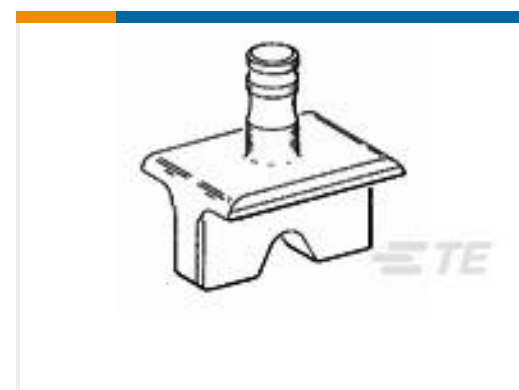

TE Part # 48129
 NEST INSERT SOLIS 065, 067 #4



TE Part # 1490413-3
 NEST,U-DIE,SOLISTRAND #4

Customers Also Bought

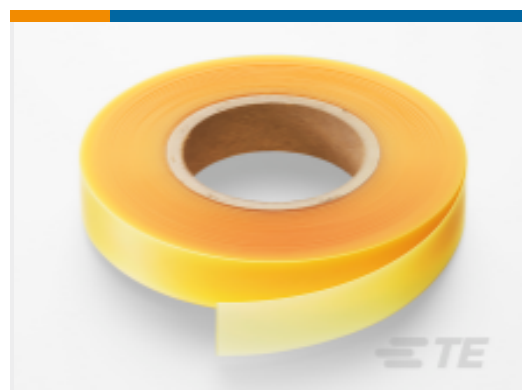

TE Part #890113-000
 S1048-TAPE-1X100-FT



TE Part #890103-000
 S1124-TAPE-0.75X100-FT

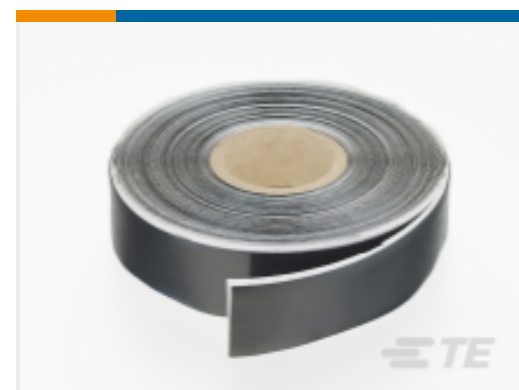

TE Part #095226-000
 S1030-TAPE-3/4X33FT



TE Part #205555-2
 AMPLIMITE,ASY,RCPT, STD,109,1

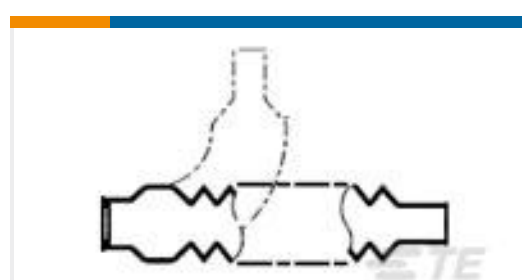

TE Part #806251-000
 202C621-51-0



TE Part #321868
 TERMINAL SOLIS RING 1 /O 3/8



TE Part #33115
 TERMINAL,SOLIS R 4 5/16



TE Part #31811
 TERMINAL,SOLIS R 4 1/4

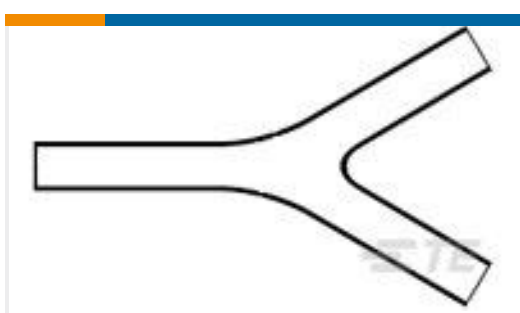

TE Part #819096-000
381A301-51-0



TE Part #DTS26W15-19PN
PLUG ASSY

Documents

Product Drawings

[TERMINAL,SOLIS R 4 3/8](#)

English

CAD Files

Customer View Model

[ENG_CVM_CVM_31812_Y.2d_dxf.zip](#)

English

[3D PDF](#)

3D

Customer View Model

[ENG_CVM_CVM_31812_Y.3d_igs.zip](#)

English

Customer View Model

[ENG_CVM_CVM_31812_Y.3d_stp.zip](#)

English

Agency Approvals

[UL](#)

English

X-ON Electronics

Largest Supplier of Electrical and Electronic Components

Click to view similar products for [Terminals](#) category:

Click to view products by [TE Connectivity](#) manufacturer:

Other Similar products are found below :

[00-054007-01074-6](#) [00-054007-70206-1](#) [00-054007-70210-8](#) [00-054007-70217-7](#) [00-054007-70226-9](#) [00-054007-70228-3](#) [00-054007-70248-1](#) [00-054007-70256-6](#) [00-054007-70301-3](#) [00-054007-70316-7](#) [00-054007-49560-4](#) [00-054007-70209-2](#) [00-054007-70225-2](#) [00-054007-70227-6](#) [00-054007-70231-3](#) [00-054007-70241-2](#) [00-054007-70242-9](#) [00-054007-70244-3](#) [00-054007-70246-7](#) [00-054007-70263-4](#) [00-054007-70288-7](#) [00-054007-70290-0](#) [00-054007-70300-6](#) [00-054007-70304-4](#) [01-2065-1-0216](#) [01-2900-1-04412](#) [00581P0075](#) [600TS-10](#) [60205-1](#) [604200-1](#) [605601-1](#) [60598-1-CUT-TAPE](#) [61314-6-C](#) [61810-3](#) [61-S](#) [61-SN](#) [626-0194](#) [62-NBM-A](#) [62-SN](#) [62-SP](#) [63-S](#) [640179-1](#) [M55155/059I03](#) [M55155/079C01](#) [M55155/099H02](#) [M55155/109H01](#) [M55155/109H02](#) [M55155/12XH05](#) [M55155/16XH02](#) [M55155/29-5S](#)