

THIS DRAWING IS UNPUBLISHED.



RELEASED FOR PUBLICATION

REVISIONS







© COPYRIGHT - By -

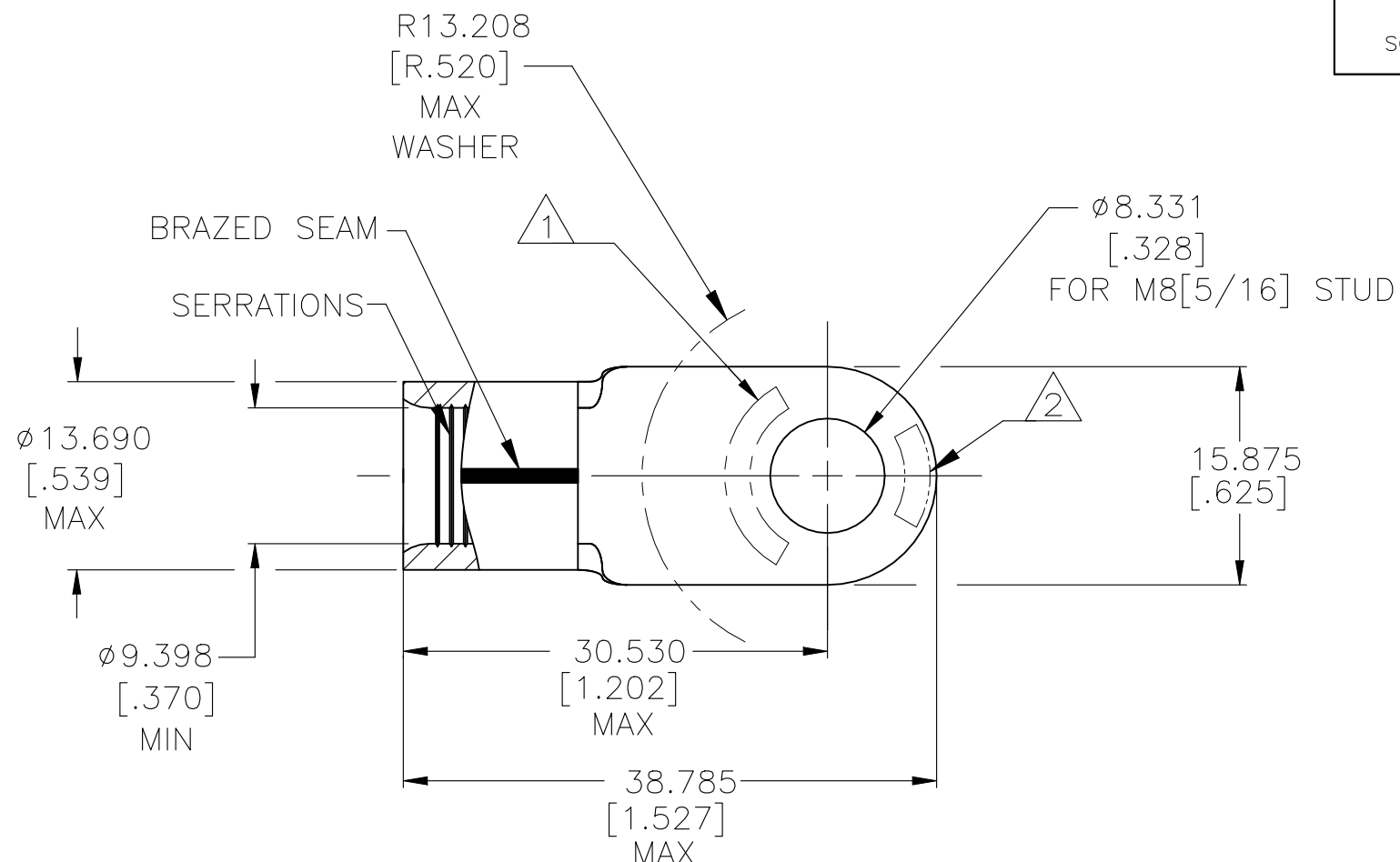







ALL RIGHTS RESERVED.

P	LTR	DESCRIPTION	DATE	DWN	APVD
	J7	REVISED PER ECO-21-007618	23JUL2021	RK	DR

AMP WIRE RANGE	 Listed FILE E13288	 LR7189 Certified	MILITARY P/N AND CLASS 
2 AWG SOLID OR STRANDED	2 AWG STRANDED	2 AWG SOLID OR STRANDED	MS 20659-147 CLASS 2



-  STAMP AMP 2W* APPROX AS SHOWN.
-  STAMP 60-75 APPROX AS SHOWN.
- 3 MATERIAL THK: 1.778±0.076[.070±.003].
-  TIN PL 0.00254[.000100] MIN EXT. THK PER ASTM B545
-  NICKEL PL 0.00762[.000300] MIN EXT THK PER SAE AMS QQ-N-290.
-  PRODUCT SPECIFICATION: SAE AS7928
- 7 NOTE DELETED
- 8 NOTE DELETED
-  PRODUCT SPECIFICATION: UL 486A-B

25	↑ LOOSE PIECE ↓	170°C[338°F]		1	8-322870-3
50		343°C[650°F]		1	2-322870-2
50		343°C[650°F]		2	322870-3
50		170°C[338°F]		2	322870-1 
50		170°C[338°F]		1	322870  
QTY.	PACKAGE TYPE	MAX TEMP RATING	FINISH	SHEET	PART NO.

AMP INCORPORATED
CUSTOMER SERVICE SYSTEMS

FOR ADDITIONAL
PRODUCT INFORMATION OR
COPIES OF DRAWINGS
AND TECHNICAL DOCUMENTS

PRODUCT INFORMATION CENTER
1-800-522-6752

FOR APPLICATION
TOOLING INFORMATION

TOOLING ASSISTANCE CENTER
1-800-722-1111

FOR ORDER ENTRY

1-800-526-5142

MAX RECOMMENDED OPERATING
TEMPERATURE:

SEE TABLE

VOLTAGE RATING:
N/A

CIRCULAR MIL AREA:
26.7-42.4mm² [52,600-83,700]
SOLID OR STRANDED

THIS DRAWING IS A CONTROLLED DOCUMENT.

DIMENSIONS:
mm[INCHES]

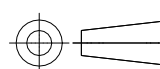

TOLERANCES UNLESS
OTHERWISE SPECIFIED:

- 0 PLC ± -
- 1 PLC ± -
- 2 PLC ± -
- 3 PLC ± 0.127 [.005]
- 4 PLC ± -
- ANGLES ± -

MATERIAL
COPPER ASTM B-152
ANNEALED

SEE TABLE

DWN DK SCHRUM 5/25/93

CHK RD HEIM 1/27/94

APVD JL MECKLEY 1/27/94

PRODUCT SPEC

APPLICATION SPEC

—

WEIGHT —

CUSTOMER DRAWING

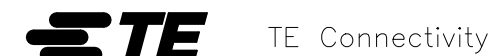

NAME
TERMINAL, RING TONGUE,
SOLISTRAND AND STRATO-THERM, WIRE SIZE: 2 AWG

SIZE A3 CAGE CODE 00779 DRAWING NO C-322870 RESTRICTED TO —

SCALE 2:1 SHEET 1 OF 2 REV J7

THIS DRAWING IS UNPUBLISHED.

RELEASED FOR PUBLICATION

-. -. .

REVISIONS

© COPYRIGHT - By -

ALL RIGHTS RESERVED.

P	LTR	DESCRIPTION	DATE	DWN	APVD
-	-	SEE SHEET 1	-	-	-

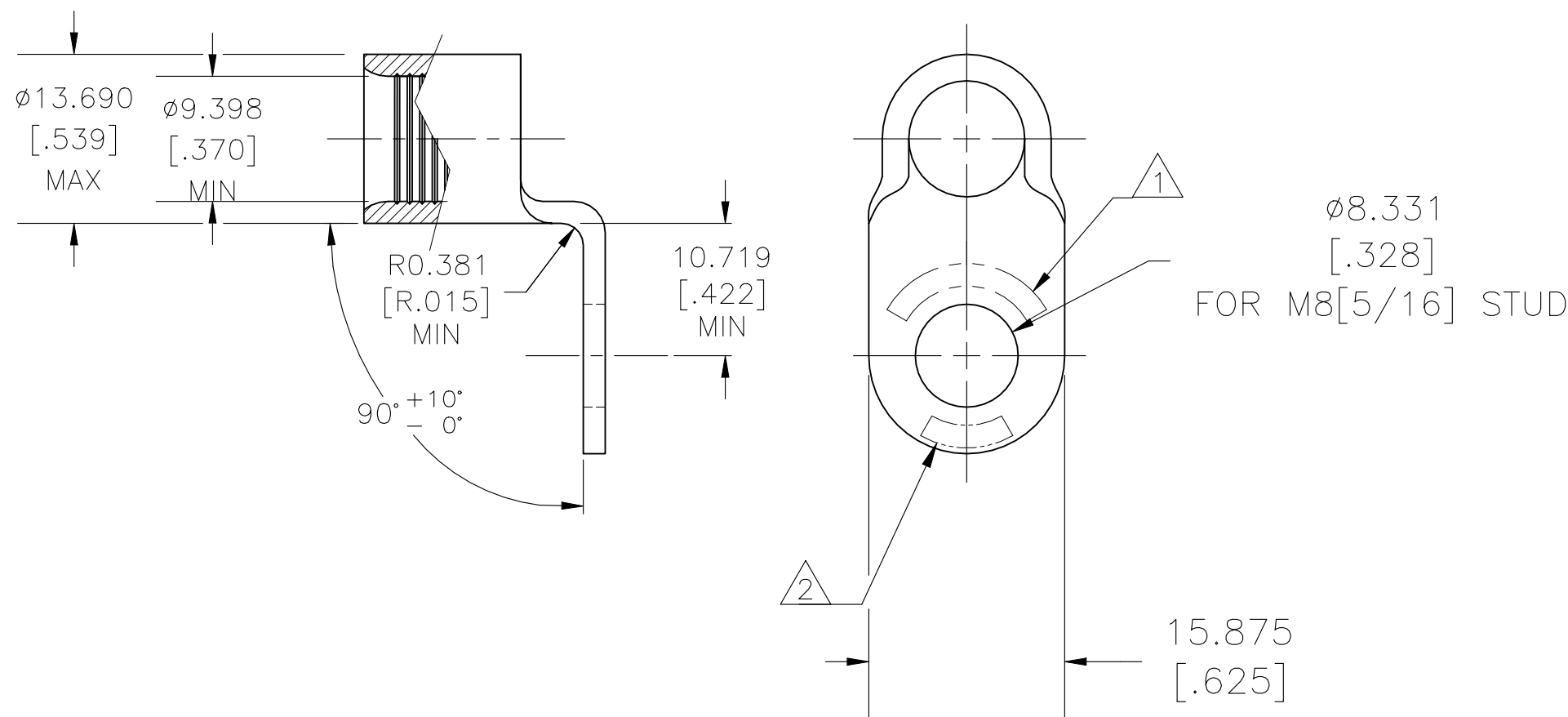

FOR P/N 322870-1 & -3 ONLY

AMP INCORPORATED CUSTOMER SERVICE SYSTEMS

MAX RECOMMENDED OPERATING TEMPERATURE:
SEE TABLE

THIS DRAWING IS A CONTROLLED DOCUMENT.

DWN DK SCHRUM 5/25/93



FOR ADDITIONAL PRODUCT INFORMATION OR COPIES OF DRAWINGS AND TECHNICAL DOCUMENTS

PRODUCT INFORMATION CENTER
1-800-522-6752

VOLTAGE RATING:
N/A

DIMENSIONS:
mm[INCHES]

TOLERANCES UNLESS OTHERWISE SPECIFIED:

CHK RD HEIM 1/27/94

APVD JL MECKLEY 1/27/94

NAME
TERMINAL, RING TONGUE,
SOLISTRAND AND STRATO-THERM, WIRE SIZE: 2 AWG

FOR APPLICATION TOOLING INFORMATION

TOOLING ASSISTANCE CENTER
1-800-722-1111

CIRCULAR MIL AREA:
26.7-42.4mm² [52,600-83,700]
SOLID OR STRANDED

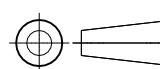

- 0 PLC ± -
- 1 PLC ± -
- 2 PLC ± -
- 3 PLC ± 0.127 [.005]
- 4 PLC ± -
- ANGLES ± -

PRODUCT SPEC

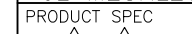

APPLICATION SPEC

SIZE	CAGE CODE	DRAWING NO	RESTRICTED TO
A3	00779	C-322870	-

FOR ORDER ENTRY 1-800-526-5142

MATERIAL
COPPER ASTM B-152
ANNEALED

FINISH
SEE TABLE

WEIGHT
CUSTOMER DRAWING

SCALE 2:1 SHEET 2 OF 2 REV J7

X-ON Electronics

Largest Supplier of Electrical and Electronic Components

Click to view similar products for [Terminals](#) category:

Click to view products by [TE Connectivity](#) manufacturer:

Other Similar products are found below :

[00-054007-01074-6](#) [00-054007-70206-1](#) [00-054007-70210-8](#) [00-054007-70217-7](#) [00-054007-70226-9](#) [00-054007-70228-3](#) [00-054007-70248-1](#) [00-054007-70256-6](#) [00-054007-70301-3](#) [00-054007-70316-7](#) [0-0320562-0](#) [00-054007-49560-4](#) [00-054007-70209-2](#) [00-054007-70225-2](#) [00-054007-70227-6](#) [00-054007-70231-3](#) [00-054007-70241-2](#) [00-054007-70242-9](#) [00-054007-70244-3](#) [00-054007-70246-7](#) [00-054007-70263-4](#) [00-054007-70288-7](#) [00-054007-70290-0](#) [00-054007-70300-6](#) [00-054007-70304-4](#) [01-2065-1-0216](#) [01-2900-1-04412](#) [00581P0075](#) [600TS-10](#) [60205-1](#) [604200-1](#) [605601-1](#) [60598-1-CUT-TAPE](#) [61314-6-C](#) [61810-3](#) [61-S](#) [61-SN](#) [626-0194](#) [62-NBM-A](#) [62-SN](#) [62-SP](#) [63-S](#) [640179-1](#) [M55155/059I03](#) [M55155/079C01](#) [M55155/099H02](#) [M55155/109H01](#) [M55155/109H02](#) [M55155/12XH05](#) [M55155/16XH02](#)