

RoHS
Ready ✓

AMP Standard Terminals and Splices

Table of Contents

Product Facts

- Solderless terminals and splices performs up to today's standards for reliable termination in applications ranging from control circuits to heavy duty power wiring
- This catalog describes only standard terminals and splices accommodating wire sizes from 26 AWG through 4/0 AWG
- These terminals are pre-insulated and color coded by wire size for easy identification
- Funnel entry on many terminals allows for easy wire insertion for high speed production
- Nylon or vinyl insulation provides high dielectric strength
- The serration or dimple feature inside the terminal barrel provides exceptional barrel contact and tensile strength
- Special plating process creates a high resistance to corrosion
- Use of AMP application tooling is designed for uniform high quality terminations
- UL, CSA, Military Approved

Table of Contents

Introduction	2, 3	■
Performance Specifications	4, 5	■
Terminal Stud Hole Sizes	6	■
PIDG (Pre-Insulated Diamond Grip)	7-32	■
Terminals.....	8-30	
Splices.....	31, 32	
PIDG FASTON	33-36	■
Terminals.....	34, 35	
Splices.....	36	
PLASTI-GRIP	37-52	■
Terminals.....	38-49	
Splices.....	50-52	
TERMINYL	53-56	■
Terminals.....	54, 55	
Splices.....	56	
CERTI-SEAL	57, 58	■
Splices and Tooling	58	
Class 1 and Class 2 Military Approvals	59- 65	■
Tooling	66-70	■
Part Numerical Index	71-73	■
Global Contacts	74	■

Numerical values

To convert U.S. customary unit values in this catalog to their metric equivalents, use the following formulas:

To convert from	to	Multiply by
inch	millimeter (mm)	2.540000 x 10
inch	metre (m)	2.540000 x 10 ⁻²
inch	centimeter (cm)	2.540000
foot	metre (m)	3.0480000 x 10 ⁻¹
pound-force	newton (N)	4.448222
bar	pascal (Pa)	1.000000 x 10 ⁵
pound-force/inch ²	pascal (Pa)	6.894757 x 10 ³
pound-mass	kilogram (kg)	4.535924 x 10 ⁻¹
ounce-mass	kilogram (kg)	2.834952 x 10 ⁻²

To convert wire size (AWG) to the equivalent metric value using the circular mil area of the wire, use the following formula:

$$\text{circular mil area (CMA)} / 1550.003 = \text{square millimeter (mm}^2\text{)}$$

Note: Dimensions in this catalog are for reference purposes only. Customer drawings are available on request.

Specifications subject to change. Consult Tyco Electronics for latest design specifications.

Need more information?

Call Technical Support:
1-800-522-6752

The Center is staffed with specialists well versed in Tyco Electronics products. They can provide you with:

- Technical Support
- Catalogs
- Technical Documents
- Product Samples

©1977, 1980, 1982, 1985, 1986, 1988, 1995, 2000 and 2008 by Tyco Electronics Corporation. All Rights Reserved.

AMP, AMP-O-ELECTRIC, AMPOMATOR, TETRA-CRIMP, AMP-TAPETRONIC, AUTO-PRO, CERTI-SEAL, DYNA-CRIMP, FASTON, PIDG, PLASTI-GRIP, PRO-CRIMPER, SHUR-PLUG, TERMINYL, T-HEAD, TE logo and Tyco Electronics are trademarks.

Terminals and Splices



PIDG Terminals and Splices
Page 7
(Insulation Restricting
Terminals also)



PIDG FASTON Terminals and Splices
Page 33
(Insulation Restricting
Terminals also)



PLASTI-GRIP Terminals and Splices
Page 37



TERMINYL Terminals and Splices
Page 53



CERTI-SEAL Splices
Page 57

Terminals and Spices (Continued)

Ordering Information

This catalog is designed for easy selection of terminal type to meet your needs. All terminals and splices are cataloged by tongue type and wire size.

If the part number is known, refer to the numerical index at the back of this catalog for page location of tabular information. In many instances the part is available in loose piece as well as tape mounted. FASTON terminals are available in strip form. When ordering tape mounted parts, specify the terminal or splice part number, the total quantity of parts required, the part number of the tooling to be used and the type of packaging desired (if applicable). The table shown at top right, lists the wire sizes available and the quantity per package for tape mounted and loose piece.

Insulated terminals and splices are color coded to indicate wire range and to help match the terminal with the appropriate tool. The table shown at right identifies the specific wire range insulation color.

Standard Packaging Quantities

Wire Size Range AWG	Packaging Quantity Loose Piece	Tape Mounted
26-22	1M/Box	2,500/Reel
22-14	1M/Box	5,000/Reel
16-14 H.D.	500/Box	2,500/Reel
12-10	500/Box	2,500/Reel
8 thru 4	100/Box	—
2 thru 4/0	50/Box	—

Note: Package quantities may vary with specific part numbers.

Insulation Color Code

Insulation Color Code	Wire Size Range AWG	Comments
Yellow	26-22	—
Transparent	24-20	—
Red	22-16	—
Blue	16-14	—
Yellow/Black	16-14	Heavy Duty
Yellow	12-10	—
Red	8	—
Blue	6	—
Yellow	4	—
Red	2	—
Blue	1/0	—
Yellow	2/0	—
Red	3/0	—
Blue	4/0	—

Terminals and Splices Performance Specifications

For detailed test information and product specifications, request appropriate report or refer to the applicable specification listed in the following table.

Product Type	Test Report Number	Application Specification
PIDG Terminals Nylon Insulation	501-31	MIL-T-7928
PIDG Insulation Restriction Terminals	GPR-575-69 110-236	MIL-T-7928/1
PIDG FASTON Terminals	—	UL310
PLASTI-GRIP Terminals	110-11514	UL486
TERMINYL Terminals	110-178	MIL-T-7928
CERTI-SEAL Terminals	—	—

Terminal and Splices Performance Specifications (Continued)

The many millions of AMP terminals and splices that have given ten, fifteen and twenty years of service are ample proof of the testing and research that went into their design and manufacturing. Like all AMP solderless wiring devices, they are thoroughly tested to conform to standards of performance under heavy usage. Tests conducted in Tyco Electronics laboratories and research facilities, some of the best-equipped in their field, indicate that these terminals and splices meet or exceed applicable industrial requirements and military specifications. The result of some of the most popular tests are tabulated here.

Upon request, a formal test report will be supplied to support these values and document additional performance requirements not listed.

MIL-T-7928

Wire Size	Spec. Min. lb.	Group III Tensile Strength After Vibration - Lb.	Group VI Tensile Strength After Corrosion - Lb.
		Terminal Type	Terminal Type
		PIDG	PIDG
26	7	11.7	10.7
24	10	19.8	19.2
22	15	29.0	23.5
20	19	37.7	46.5
18	38	58.9	70.5
16	50	78.5	81.9
14	70	100	105
12	110	209	213
10	150	247	282
		TERMINYL	TERMINYL
8	225	299	310
6	300	600	609
4	400	784	835
2	550	1,035	1,136
1/0	700	1,781	1,767
2/0	750	1,787	1,721
3/0	825	2,845	2,880
4/0	875	3,048	3,268

MIL-T-7928

Wire Size	Specification Maximum Millivolt Drop ¹	Group II Millivolt Drop After Current Cycling ²	Group III Millivolt Drop After Vibration ²	Group VI Millivolt Drop After Corrosion ²
		Terminal Type	Terminal Type	Terminal Type
		PIDG	PIDG	PIDG
26	9.2	3.2	3.1	3.3
24	7.9	2.6	4.9	2.9
22	9.0	4.5	3.8	6.0
20	7.5	3.6	3.8	3.6
18	7.2	3.1	3.6	3.1
16	7.7	3.6	3.7	3.9
14	7.7	3.7	4.0	3.6
12	8.4	4.0	4.6	4.2
10	7.5	3.3	3.6	3.3
		TERMINYL	TERMINYL	TERMINYL
8	5.2	3.7	3.8	4.2
6	5.7	4.3	4.1	4.1
4	5.4	4.1	4.0	4.1
2	5.5	4.2	4.2	4.2
1/0	6.8	4.4	4.3	4.4
2/0	6.7	4.2	4.2	4.2
3/0	6.3	4.2	4.1	4.1
4/0	6.4	4.0	4.1	4.1

¹Value is millivolt drop permitted after test plus equal length of wire.

²Value includes equal length of wire.

Terminal Stud Hole Size





















Use to Select Proper Size Terminal

The chart shows sizes and dimensions of various studs and the corresponding terminal stud hole sizes used with AMP devices.

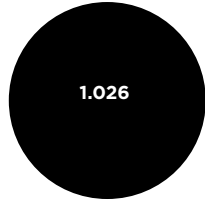
For example, with stud #5 (.125 Diameter), use AMP device listed for #5 stud (.129 Hole Diameter).

Terminal stud hole sizes may easily be checked by fitting sample terminal to black circle.

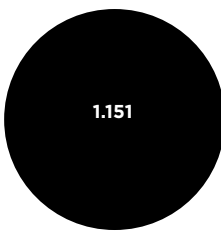
Terminal Stud Hole Sizes

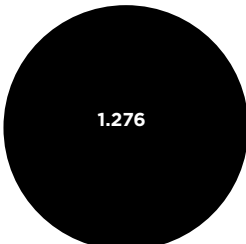
Stud Size		Stud Dia.	Minimum Terminal Hole Diameter		Stud Size		Stud Dia.	Minimum Terminal Hole Diameter	
U.S. Cust.	Metric				U.S. Cust.	Metric			
#0		.060		.064					
#1		.073		.077	5/8"	M16	.625		.651
#2	M2	.086		.090					
#3		.099		.103					
#4		.112		.116	3/4"		.750		.776
#5	M3	.125		.129					
#6	M3.5	.138		.142					
#8	M4	.164		.168	7/8"	M22	.875		.901
#10		.190		.194					
#12		.216		.220					
#14		.242		.245	1"		1.000		1.026
1/4"	M6	.250		.260					
5/16"	M8	.312		.323					
3/8"		.375		.385	1 1/8"		1.125		1.151
7/16"		.437		.448					
1/2"	M12	.500		.510	1 1/4"		1.250		1.276

PIDG Terminals and Splices

Product Facts

- Pre-insulated terminal designed for uniform reliability in most difficult circuit environments
- PIDG Terminals consist of tin plated copper or tin plated phosphor bronze for spring spades with a copper sleeve and insulation sleeve fitted over terminal barrel
- Design of the tool dies and construction of the terminal allows for uniform insulation thickness under crimping pressure, transmitting this pressure evenly to the center of the crimp area

The AMP Mated Tool/Terminal Concept

- AMP compression crimping produces crimps for a given size wire and terminal that are alike in appearance and performance
- Terminal and crimping tool are designed as uniform matched devices
- Dies are precision-engineered from the finest hard-metal alloys
- Crimping pressure is controlled by a ratchet device on the hand tool or a corresponding pre-calibration in the crimping jaws of AMP automated crimping machines

The Crimp

- When done properly, crimping pressure can neither overstress nor under stress the terminal barrel—machined dies fully bottom to the precise crimp height
- Resulting termination is free of contamination
- Resistant to shock and critical environments
- Tensile strength approaches that of the wire itself
- PIDG Terminals meet or exceed the requirements of MIL-T-7928, Type II, Class 1 and 2
- Refer to AMP Qualified Products for Military Application, Catalog 73-159 for Military Specification Number to AMP Part Number cross reference

Nylon Insulation. Nylon sleeve has high dielectric strength.

Color Coding. Terminal insulation is color-coded by wire range to prevent errors during installation.

Serrations. Serrations inside barrel provide maximum contact and tensile strength after crimping.

Funnel Ramp Entry. Prevents a turned back strand and permits rapid wire insertion during high speed production.

Copper Sleeve. The specially designed copper sleeve, fitted over the terminal barrel, provides circumferential insulation support to the wire and allows the wire to be bent in any direction, without fraying the wire's insulation or breaking the conductor.

Basic Terminal Material. The basic terminal is constructed of fine grade high conductivity copper per ASTM B-152 and tin-plated per ASTM B-545. Basic material for Spring Spade Tongue Terminals is phosphor bronze per ASTM B-139 and tin-plated per ASTM B-545. Tyco Electronics' special plating process creates durable corrosion resistance to salt spray and most chemical fumes.

Temperature Rating: 105°C Max. Note: Over size expansions are provided in vinyl insulation only.

AMP PIDG Terminals (Use PIDG Tooling)		AMP PIDG Nylon Butt Window Splice (Use PIDG Tooling)	
AMP Wire Range	UL LISTED	SR [®] LR7189 Certified	AMP Wire Range
22-16 22-16 Solid or Stranded			22-16 22-16 Stranded or Solid
16-14 16-14 Solid or Stranded			16-14 16-14 Stranded or Solid
12-10 12-10 Solid or Stranded			12-10 12-10 Stranded or Solid
Note: 22-16 terminals are stamped 22-18 in accordance with MIL-T-7928.		Note: 22-16 splices are stamped 22-18 in accordance with MIL-T-7928.	
¹ UL & CSA — Nylon			

PIDG Terminals and Splices (Continued)

Ring Tongue Terminals

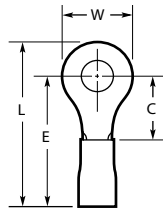

Material
Insulation-Nylon, UL 94V-2
Terminal Body and Metallic Sleeve-Copper per ASTM B-152
Plating-Tin per ASTM B-545

Related Product Data
Insulation Color Code -pg. 4
Packaging Quantities -pg. 4
Performance Specifications - pgs. 4 & 5
Application Tooling -pg. 66

Wire Size Circular Mils [mm ²]	Tongue Material Thickness Max.	Stud Size	Dimensions				Terminal Insulation Color	Wire Insulation Diameter Max.	Part Numbers	
			W	C Min.	E Max.	L Max.			Loose Piece	Tape Mounted
26-24 238-475 [0.12-0.24]	.029 0.74	2 M2	.203 5.16	.211 5.36	.632 16.05	.739 18.77	Yellow	.105 2.67	54310-1'	—
		4	.203 5.16	.211 5.36	.632 16.05	.736 18.69	Yellow	.105 2.67	52189'	—
		6 M3.5	.250 6.35	.243 6.17	.664 16.87	.792 20.12	Yellow	.105 2.67	53073'	—
		8 M4	.281 7.14	.250 6.35	.671 17.04	.814 20.68	Yellow	.105 2.67	54311-1'	—
		10	.312 7.92	.281 7.14	.702 17.83	.868 22.05	Yellow	.105 2.67	54312-1'	54312-2'
26-22 202-810 [0.10-0.41]	.020 0.51	0	.140 3.56	.121 3.07	.452 11.48	.525 13.34	Yellow	.082 2.08	321013	—
		2 M2	.140 3.56	.121 3.07	.452 11.48	.525 13.34	Yellow	.082 2.08	323912*	2-323912-1
			.140 3.56	.211 5.36	.542 13.77	.615 15.62	Yellow	.082 2.08	329951*	—
			.165 4.19	.211 5.36	.542 13.77	.617 15.67	Yellow/Br.	.082 2.08	321620*	1-321620-0
		4	.203 5.16	.211 5.36	.542 13.77	.646 16.41	Yellow	.082 2.08	323913	2-323913-1
			.203 5.16	.211 5.36	.542 13.77	.646 16.41	Yellow	.082 2.08	323914*	2-323914-1
			.198 5.03	.308 7.82	.643 16.33	.745 18.92	Yellow	.082 2.08	321617	—
		6 M3.5	.203 5.16	.211 5.36	.542 13.77	.646 16.41	Yellow	.082 2.08	323915*	2-323915-2
			.250 6.35	.281 7.14	.612 15.54	.740 18.80	Yellow	.082 2.08	326875*	2-326875-1
			.250 6.35	.281 7.14	.612 15.54	.740 18.80	Yellow	.082 2.08	323916*	2-323916-1
		8 M4	.300 7.62	.281 7.14	.612 15.54	.765 19.43	Yellow	.082 2.08	52124	52124-2
			10	.250 6.35	.281 7.14	.612 15.54	.740 18.80	Yellow	.082 2.08	324075*
	.300 7.62	.281 7.14		.612 15.54	.765 19.43	Yellow	.082 2.08	52124-1	—	
	24-20 320-1,290 [0.16-0.65]	.025 0.64	0	.160 4.06	.125 3.18	.506 12.85	.589 14.96	Natural	.100 2.54	—
2 M2			.160 4.06	.125 3.18	.506 12.85	.589 14.96	Natural	.100 2.54	329636	2-329636-1
4			.203 5.16	.250 6.35	.631 16.03	.735 18.67	Natural	.100 2.54	50534	—
			.281 7.14	.250 6.35	.631 16.03	.774 19.66	Natural	.100 2.54	323985	—
6 M3.5			.281 7.14	.250 6.35	.631 16.03	.774 19.66	Natural	.100 2.54	323986	2-323986-1
8 M4			.312 7.92	.281 7.14	.662 16.81	.821 20.85	Natural	.100 2.54	323989	1-323989-0
10			.312 7.92	.281 7.14	.662 16.81	.821 20.85	Natural	.100 2.54	323990	2-323990-1

*Available in small packaging quantities.

Note: "C" dimension applies from edge of metal wire barrel to center of stud hole.

¹Must be crimped with 22-18 or 22-16 PIDG (red) Tooling.

PIDG Terminals and Splices (Continued)

Ring Tongue Terminals

(Continued)

Wire Size Circular Mills [mm ²]	Tongue Material Thickness Max.	Stud Size	Dimensions				Terminal Insulation Color	Wire Insulation Diameter Max.	Part Numbers	
			W	C Min.	E Max.	L Max.			Loose Piece	Tape Mounted
22-16 509-3,260 [0.26-1.65]	.033 0.84	1	.160 4.06	.156 3.96	.560 14.22	.643 16.33	Red	.125 3.18	327174	2-327174-1
			.182 4.62	.172 4.37	.576 14.63	.669 16.99	Red	.125 3.18	324158	2-324158-1
		2 M2	.182 4.62	.172 4.37	.576 14.63	.669 16.99	Red	.140 3.56	320773	—
			.218 5.54	.156 3.96	.560 14.22	.672 17.07	Red	.125 3.18	328657*	2-328657-1
		4	.182 4.62	.172 4.37	.576 14.63	.669 16.99	Red/Green	.125 3.18	327654*	—
			.182 4.62	.172 4.37	.576 14.63	.669 16.99	Red	.140 3.56	320882*	2-320882-1
			.218 5.54	.156 3.96	.560 14.22	.672 17.07	Red	.125 3.18	320553*	2-320553-2
			.218 5.54	.156 3.96	.560 14.22	.672 17.07	Red	.125 3.18	36254 ¹	—
			.218 5.54	.156 3.96	.560 14.22	.672 17.07	Red	.140 3.56	31880*	2-31880-1
			.218 5.54	.156 3.96	.560 14.22	.672 17.07	Black	.140 3.56	35229	—
			.250 6.35	.312 7.92	.716 18.19	.844 21.44	Red	.125 3.18	323758	2-323758-1
			.250 6.35	.312 7.92	.716 18.19	.844 21.44	Red	.140 3.56	330648	2-330648-1
			.218 5.54	.156 3.96	.560 14.22	.672 17.07	Red	.125 3.18	36149*	2-36149-2
			.218 5.54	.156 3.96	.560 14.22	.672 17.07	Red	.140 3.56	36150*	2-36150-1
		6 M3.5	.250 6.35	.250 6.35	.654 16.61	.782 19.86	Red	.125 3.18	51863*	51863-1
			.281 7.14	.250 6.35	.654 16.61	.797 20.24	Red	.125 3.18	36151*	2-36151-2
			.281 7.14	.250 6.35	.654 16.61	.797 20.24	Red	.140 3.56	36152*	2-36152-1
			.312 7.92	.281 7.14	.685 17.40	.844 21.44	Red	.125 3.18	323008	2-323008-1
			.312 7.92	.281 7.14	.685 17.40	.844 21.44	Red	.140 3.56	326878	2-326878-1
			.281 7.14	.250 6.35	.654 16.61	.797 20.24	Red	.125 3.18	320554*	2-320554-1
			.281 7.14	.250 6.35	.654 16.61	.797 20.24	Red	.140 3.56	31886*	2-31886-2
			.312 7.92	.281 7.14	.685 17.40	.844 21.44	Red	.125 3.18	320551*	1-320551-1
			.312 7.92	.281 7.14	.685 17.40	.844 21.44	Red	.140 3.56	31890*	2-31890-1
			.344 8.74	.297 7.54	.701 17.81	.876 22.25	Red	.140 3.56	32835	2-32835-2
8 M4	.281 7.14	.250 6.35	.654 16.61	.797 20.24	Red	.125 3.18	320552*	2-320552-1		
	.281 7.14	.250 6.35	.654 16.61	.797 20.24	Red	.140 3.56	31887*	2-31887-1		
	.312 7.92	.281 7.14	.685 17.40	.844 21.44	Red	.125 3.18	36153*	2-36153-2		
	.312 7.92	.281 7.14	.685 17.40	.844 21.44	Red	.140 3.56	36154*	2-36154-2		
	.344 8.74	.297 7.54	.701 17.81	.876 22.25	Red	.125 3.18	32836*	—		
	.344 8.74	.297 7.54	.701 17.81	.876 22.25	Red	.140 3.56	32837*	32837-1		

*Available in small packaging quantities.

¹Slightly larger than standard #4 stud hole. (.128 in./3.25 mm.)

Note: "C" dimension applies from edge of metal wire barrel to center of stud hole.

PIDG Terminals and Splices (Continued)

Ring Tongue Terminals

(Continued)

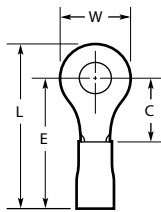

Material

Insulation-Nylon, UL 94V-2

Terminal Body and Metallic Sleeve-Copper per ASTM B-152

Plating-Tin per ASTM B-545

Related Product Data

Insulation Color Code -pg. 4

Packaging Quantities -pg. 4

Performance Specifications - pgs. 4 & 5

Application Tooling-pg. 66

PIDG Terminals and Splices

Wire Size Circular Mills [mm ²]	Tongue Material Thickness Max.	Stud Size	Dimensions				Terminal Insulation Color	Wire Insulation Diameter Max.	Part Numbers			
			W	C Min.	E Max.	L Max.			Loose Piece	Tape Mounted		
22-16 509-3,260 [0.26-1.65]	.033 0.84	1/4 M6	.469 11.91	.437 11.10	.841 21.36	1.078 27.38	Red	.125 3.18	320571*	2-320571-2		
			.469 11.91	.437 11.10	.841 21.36	1.078 27.38	Black	.125 3.18	55936-1	55936-2		
			.469 11.91	.437 11.10	.841 21.36	1.078 27.38	Red	.140 3.56	31894*	2-31894-2		
		5/16 M8	.469 11.91	.437 11.10	.841 21.36	1.078 27.38	Red	.125 3.18	320572*	2-320572-1		
			.469 11.91	.437 11.10	.841 21.36	1.078 27.38	Red	.140 3.56	31895*	2-31895-1		
			.531 13.49	.546 13.87	.950 24.13	1.218 30.94	Red	.125 3.18	324123	—		
		3/8	.531 13.49	.546 13.87	.950 24.13	1.218 30.94	Red	.125 3.18	320573*	2-320573-4		
			.531 13.49	.546 13.87	.950 24.13	1.218 30.94	Red	.140 3.56	31897*	2-31897-2		
			.656 16.66	.437 11.10	.841 21.36	1.171 29.74	Red	.125 3.18	321522	—		
		1/2 M12	.713 18.11	.530 13.46	.934 23.72	1.293 32.84	Red	.125 3.18	328975*	—		
		20-16HD ¹ 992-2,800 [0.50-1.42]	.042 1.07	10	.469 11.91	.312 7.92	.718 18.24	.955 24.26	Blue	.150 3.81	150247	—
				2 M2	.180 4.57	.171 4.34	.575 14.61	.668 16.97	Blue	.170 4.32	324993	—
.250 6.35	.171 4.34				.575 14.61	.703 17.86	Blue	.150 3.81	324159*	2-324159-2		
4	.250 6.35			.171 4.34	.575 14.61	.703 17.86	Blue	.170 4.32	328996*	2-328996-1		
	.250 6.35			.281 7.14	.685 17.40	.813 20.65	Blue	.150 3.81	323676	—		
	.250 6.35			.171 4.34	.575 14.61	.703 17.86	Blue	.150 3.81	320561*	2-320561-2		
6 M3.5	.250 6.35			.171 4.34	.575 14.61	.703 17.86	Blue	.170 4.32	320619*	2-320619-1		
	.250 6.35			.281 7.14	.685 17.40	.813 20.65	Blue	.170 4.32	50881	50881-2		
	.312 7.92			.250 6.35	.654 16.61	.813 20.65	Blue	.170 4.32	326882*	2-326882-1		
	.312 7.92			.281 7.14	.685 17.40	.844 21.44	Blue	.150 3.81	51864*	51864-3		
	.343 8.71			.281 7.14	.685 17.40	.859 21.82	Blue	.150 3.81	36157*	2-36157-2		
	.343 8.71			.281 7.14	.685 17.40	.859 21.82	Blue	.170 4.32	36158*	2-36158-1		
8 M4	.312 7.92	.250 6.35	.654 16.61	.813 20.65	Blue	.170 4.32	53941-1*	53941-2				
	.312 7.92	.281 7.14	.685 17.40	.844 21.44	Blue	.150 3.81	51864-1*	51864-5				
	.343 8.71	.281 7.14	.685 17.40	.859 21.82	Blue	.150 3.81	320560*	2-320560-1				
	.343 8.71	.281 7.14	.685 17.40	.859 21.82	Blue	.170 4.32	320565*	2-320565-1				

*Available in small packaging quantities.

¹Heavy duty for extra mechanical strength.

Note: "C" dimension applies from edge of metal wire barrel to center of stud hole.

PIDG Terminals and Splices (Continued)

Ring Tongue Terminals
(Continued)

Wire Size Circular Mills [mm ²]	Tongue Material Thickness Max.	Stud Size	Dimensions				Terminal Insulation Color	Wire Insulation Diameter Max.	Part Numbers			
			W	C Min.	E Max.	L Max.			Loose Piece	Tape Mounted		
16-14 2,050-5,180 [1.04-2.62]	.033 0.84	10	.312 7.92	.250 6.35	.654 16.61	.813 20.65	Blue	.170 4.32	53942-1	53942-2		
			.312 7.92	.281 7.14	.685 17.40	.844 21.44	Blue	.150 3.81	51864-2*	51864-4		
			.343 8.71	.281 7.14	.685 17.40	.859 21.82	Blue	.150 3.81	320574*	2-320574-2		
			.343 8.71	.281 7.14	.685 17.40	.859 21.82	Blue	.170 4.32	36160*	2-36160-1		
		12	.469 11.91	.437 11.10	.841 21.36	1.078 27.38	Blue	.170 4.32	324533	2-324533-2		
			.469 11.91	.437 11.10	.841 21.36	1.078 27.38	Blue	.170 4.32	324086	2-324086-1		
		14	.468 11.89	.312 7.92	.716 18.19	.953 24.21	Blue	.170 4.32	35274	—		
			.469 11.91	.437 11.10	.841 21.36	1.078 27.38	Blue	.150 3.81	320563*	2-320563-2		
		1/4 M6	.469 11.91	.437 11.10	.841 21.36	1.078 27.38	Blue	.170 4.32	321045*	2-321045-1		
			.469 11.91	.437 11.10	.841 21.36	1.078 27.38	Black	.170 4.32	325034	2-325034-1		
		5/16 M8	.469 11.91	.437 11.10	.841 21.36	1.078 27.38	Blue	.150 3.81	320575*	2-320575-1		
			.469 11.91	.437 11.10	.841 21.36	1.078 27.38	Blue	.170 4.32	328998*	2-328998-1		
		3/8	.531 13.49	.546 13.87	.950 24.13	1.218 30.94	Blue	.150 3.81	320564*	2-320564-3		
			.531 13.49	.546 13.87	.950 24.13	1.218 30.94	Blue	.170 4.32	328999*	2-328999-1		
		1/2 M12	.713 18.11	.530 13.46	.934 23.72	1.293 32.84	Blue	.150 3.81	328976	—		
			.713 18.11	.530 13.46	.934 23.72	1.293 32.84	Blue	.170 4.32	328849*	—		
		16-14HD ¹ 2,050-5,180 [1.04-2.62]	.050 1.27	4	.281 7.14	.219 5.56	.810 20.57	.953 24.21	Yellow/Blk.	.230 5.84	33734	—
					.281 7.14	.219 5.56	.810 20.57	.953 24.21	Yellow/Blk.	.230 5.84	320631*	2-320631-1
				6 M3.5	.281 7.14	.219 5.56	.810 20.57	.953 24.21	Yellow/Blk.	.250 6.35	35634*	—
					.343 8.71	.281 7.14	.872 22.15	1.046 26.57	Yellow/Blk.	.230 5.84	33724	—
8 M4	.343 8.71			.281 7.14	.872 22.15	1.046 26.57	Yellow/Blk.	.230 5.84	320627*	1-320627-0		
	.343 8.71			.281 7.14	.872 22.15	1.046 26.57	Yellow/Blk.	.250 6.35	35106*	2-35106-1		
10	.343 8.71			.281 7.14	.872 22.15	1.046 26.57	Yellow/Blk.	.230 5.84	320630*	2-320630-2		
	.343 8.71			.281 7.14	.872 22.15	1.046 26.57	Yellow/Blk.	.250 6.35	34805*	2-34805-1		
1/4 M6	.500 12.70			.344 8.74	1.179 29.95	1.432 36.37	Yellow/Blk.	.220 5.59	329391	—		
	.500 12.70			.344 8.74	.935 23.75	1.188 30.18	Yellow/Blk.	.230 5.84	34974*	2-34974-1		
5/16 M8	.500 12.70			.344 8.74	.935 23.75	1.188 30.18	Yellow/Blk.	.250 6.35	323682	2-323682-1		
	.531 13.49			.437 11.10	1.028 26.11	1.296 32.92	Yellow/Blk.	.230 5.84	327743	1-327743-1		
	.531 13.49	.437 11.10	1.028 26.11	1.296 32.92	Yellow/Blk.	.250 6.35	34806*	2-34806-3				
	.531 13.49	.437 11.10	1.028 26.11	1.296 32.92	Blue	.250 6.35	—	2-34806-2				

*Available in small packaging quantities.

¹Heavy duty for extra mechanical strength.

Note: "C" dimension applies from edge of metal wire barrel to center of stud hole.

PIDG Terminals and Splices (Continued)

Ring Tongue Terminals
(Continued)

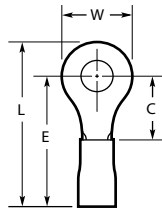

Material
Insulation-Nylon, UL 94V-2
Terminal Body and Metallic Sleeve-Copper per ASTM B-152
Plating-Tin per ASTM B-545 except where noted.

Related Product Data
Insulation Color Code -pg. 4
Packaging Quantities -pg. 4
Performance Specifications -pgs. 4 & 5
Application Tooling-pg. 66

Wire Size Circular Mils [mm ²]	Tongue Material Thickness Max.	Stud Size	Dimensions				Terminal Insulation Color	Wire Insulation Diameter Max.	Part Numbers		
			W	C Min.	E Max.	L Max.			Loose Piece	Tape Mounted	
16-14HD ¹ 2,050-5,180 [1.04-2.62]	.050 1.27	3/8	.531 13.49	.437 11.10	1.028 26.11	1.296 32.92	Yellow/Blk.	.230 5.84	330896	—	
			1/2 M12	.750 19.05	.625 15.88	1.216 30.89	1.594 40.49	Yellow/Blk.	.250 6.35	35316*	—
				1.250 31.75	1.000 25.40	1.591 40.41	2.219 56.36	Yellow/Blk.	.250 6.35	36203	—
		3/4	1.250 31.75	1.000 25.40	1.591 40.41	2.219 56.36	Yellow/Blk.	.250 6.35	322724	—	—
			4	.281 7.14	.219 5.56	.810 20.57	.953 24.21	Yellow	.250 6.35	35148*	1-35148-1
				.281 7.14	.219 5.56	.810 20.57	.953 24.21	Yellow	.230 5.84	320634*	2-320634-1
		.281 7.14		.219 5.56	.810 20.57	.953 24.21	Yellow	.250 6.35	35149*	2-35149-1	
		6 M3.5	.312 7.92	.302 7.67	.893 22.68	1.052 26.72	Yellow	.230 5.84	326886	326886-1	
			.375 9.53	.302 7.67	.893 22.68	1.083 27.51	Yellow	.230 5.84	320567*	2-320567-2	
			.375 9.53	.302 7.67	.893 22.68	1.083 27.51	Yellow	.250 6.35	35107*	2-35107-1	
			.312 7.92	.281 7.14	.872 22.15	1.031 26.19	Yellow	.230 5.84	35787*	1-35787-0	
			.312 7.92	.302 7.67	.893 22.68	1.052 26.72	Yellow	.230 5.84	324915*	—	
.375 9.53	.302 7.67		.893 22.68	1.083 27.51	Yellow	.230 5.84	320568*	2-320568-1			
8 M4	.375 9.53	.302 7.67	.893 22.68	1.083 27.51	Yellow	.250 6.35	35108*	2-35108-1			
	.312 7.92	.302 7.67	.893 22.68	1.052 26.72	Yellow	.230 5.84	324918*	1-324918-0			
	.343 8.71	.281 7.14	.872 22.15	1.046 26.57	Yellow	.230 5.84	32883*	1-32883-0			
	.375 9.53	.302 7.67	.893 22.68	1.083 27.51	Yellow	.230 5.84	36161*	2-36161-2			
	.375 9.53	.302 7.67	.893 22.68	1.083 27.51	Yellow	.250 6.35	35109*	2-35109-1			
	.500 12.70	.344 8.74	.935 23.75	1.188 30.18	Yellow	.230 5.84	2-323762-1	2-323762-3			
10	.500 12.70	.344 8.74	1.179 29.95	1.432 36.37	Yellow	.220 5.59	329389	—			
	.500 12.70	.344 8.74	.935 23.75	1.188 30.18	Yellow	.230 5.84	35273*	2-35273-2			
	.531 13.49	.468 11.89	1.054 26.77	1.322 33.58	Yellow	.230 5.84	320569*	2-320569-3			
	.531 13.49	.468 11.89	1.054 26.77	1.322 33.58	Yellow	.230 5.84	—	2-32545-4 ²			
	.531 13.49	.468 11.89	1.054 26.77	1.322 33.58	Yellow	.250 6.35	35110*	2-35110-1			
	.500 12.70	.344 8.74	.935 23.75	1.188 30.18	Yellow	.230 5.84	35273*	2-35273-2			
1/4 M6	.531 13.49	.468 11.89	1.054 26.77	1.322 33.58	Yellow	.230 5.84	320569*	2-320569-3			
	.531 13.49	.468 11.89	1.054 26.77	1.322 33.58	Yellow	.230 5.84	—	2-32545-4 ²			
	.531 13.49	.468 11.89	1.054 26.77	1.322 33.58	Yellow	.250 6.35	35110*	2-35110-1			

*Available in small packaging quantities.

¹Heavy duty for extra mechanical strength.

²Terminal body plating — Gold per MIL-G-45204 Type II over Nickel per QQ-N-290.

³Terminal body plating — Nickel per QQ-N-290.

Note: “C” dimension applies from edge of metal wire barrel to center of stud hole.

PIDG Terminals and Splices (Continued)

Ring Tongue Terminals
(Continued)

Wire Size Circular Mils [mm ²]	Tongue Material Thickness Max.	Stud Size	Dimensions				Terminal Insulation Color	Wire Insulation Diameter Max.	Part Numbers	
			W	C Min.	E Max.	L Max.			Loose Piece	Tape Mounted
12-10 5,180-13,100 [2.62-6.64]	.042 1.07	M5	.375 9.53	.302 7.67	.967 24.56	1.160 29.46	Yellow	.300 7.62	—	55157-2 ¹
		5/16 M8	.531 13.49	.468 11.89	1.054 26.77	1.322 33.58	Yellow	.230 5.84	320576*	2-320576-1
			.531 13.49	.468 11.89	1.054 26.77	1.322 33.58	Yellow	.250 6.35	35111*	2-35111-1
		3/8	.593 15.06	.531 13.49	1.115 28.32	1.414 35.92	Yellow	.230 5.84	320577*	2-320577-3
			.593 15.06	.531 13.49	1.115 28.32	1.414 35.92	Yellow	.250 6.35	35112*	—
		1/2 M12	.750 19.05	.625 15.88	1.216 30.89	1.594 40.49	Yellow	.250 6.35	35150	—
			.715 18.16	.474 12.04	1.065 27.05	1.414 35.92	Yellow	.230 5.84	52077	—
		5/8 M16	.715 18.16	.560 14.22	1.151 29.24	1.511 38.38	Yellow	.230 5.84	331467	—
			.750 19.05	.625 15.88	1.216 30.89	1.594 40.49	Yellow	.230 5.84	323784	—
		5/8 M16	.750 19.05	.625 15.88	1.216 30.89	1.594 40.49	Yellow	.250 6.35	35151*	—
			1.250 31.75	1.000 25.40	1.591 40.41	2.219 56.36	Yellow	.230 5.84	324615	—

*Available in small packaging quantities.

Note: "C" dimension applies from edge of metal wire barrel to center of stud hole.

¹Vinyl insulation material

PIDG Terminals and Splices (Continued)

Ring Tongue Terminals

(Vinyl)

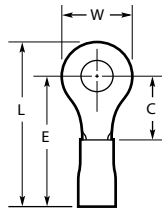

Material

Insulation-Vinyl, UL 94V-0

Terminal Body and Metallic Sleeve-Copper per ASTM B-152

Plating-Tin per ASTM B-545 except where noted.

PIDG Terminals and Splices

Wire Size Circular Mills [mm ²]	Tongue Material Thickness Max.	Stud Size	Dimensions				Terminal Insulation Color	Wire Insulation Diameter Max.	Part Numbers		
			W	C Min.	E Max.	L Max.			Loose Piece	Tape Mounted	
22-16 509-3,260 [0.26-1.65]	.033 0.84	6 M3.5	.281 7.14	.250 6.35	.654 16.61	.797 20.24	Red	.140 3.56	31885	—	
		8 M4	.312 7.92	.281 7.14	.685 17.40	.844 21.44	Red	.125 3.18	31888	—	
			.312 7.92	.281 7.14	.685 17.40	.844 21.44	Red	.125 3.18	2-31888-1 ²	—	
		10	.281 7.14	.250 6.35	.654 16.61	.797 20.24	Red	.125 3.18	31884	—	
			.312 7.92	.281 7.14	.685 17.40	.844 21.44	Red	.140 3.56	31891	—	
		16-14 2,050-5,180 [1.04-2.62]	.033 0.84	10	.312 7.92	.250 6.35	.654 16.61	.813 20.65	Blue	.170 4.32	—
.312 7.92	.281 7.14				.685 17.40	.844 21.44	Blue	.150 3.81	—	51861-4	
.343 8.71	.281 7.14				.685 17.40	.859 21.82	Blue	.170 4.32	31903	—	
10	.343 8.71			.281 7.14	.961 24.41	1.135 28.83	Yellow/Blk.	.300 7.62	35363*	—	
	1/4 M6			.531 13.49	.437 11.10	1.117 28.37	1.385 35.18	Yellow/Blk.	.300 7.62	35362*	—
	5/16 M8			.531 13.49	.437 11.10	1.117 28.37	1.385 35.18	Yellow/Blk.	.300 7.62	35538	—
16-14HD ¹ 2,050-5,180 [1.04-2.62]	.050 1.27	1/2 M12	1.250 31.75	1.000 25.40	1.680 42.67	2.308 58.62	Yellow/Blk.	.300 7.62	36485	—	
		6 M3.5	.375 9.53	.302 7.67	.982 24.94	1.172 29.77	Yellow	.300 7.62	35604	—	
		8 M4	.375 9.53	.302 7.67	.982 24.94	1.172 29.77	Yellow	.300 7.62	35605*	2-35605-2	
		10	.375 9.53	.302 7.67	.982 24.94	1.172 29.77	Yellow	.300 7.62	35364*	2-35364-1	
		5mm ³	.375 9.53	.302 7.67	.967 24.56	1.160 29.46	Yellow	.300 7.62	—	55157-2	
		1/4 M6	.500 12.70	.344 8.74	1.024 26.01	1.277 32.44	Yellow	.300 7.62	323763	2-323763-2	
.531 13.49	.468 11.89		1.148 29.16	1.416 35.97	Yellow	.300 7.62	35345*	2-35345-1			
5/16 M8	.531 13.49	.468 11.89	1.148 29.16	1.416 35.97	Yellow	.300 7.62	35346*	2-35346-1			
	3/8	.593 15.06	.531 13.49	1.211 30.76	1.510 38.35	Yellow	.300 7.62	35478	1-35478-0		

*Available in small packaging quantities.

¹Heavy duty for extra mechanical strength.

²Terminal body plating — Gold per MIL-G-45204 Type II over Nickel per QQ-N-290.

³#10 stud may be substituted.

Note: "C" dimension applies from edge of metal wire barrel to center of stud hole.

PIDG Terminals and Splices (Continued)

Ring Tongue Terminals
(Insulation Restricting)

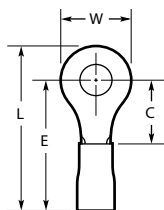

Material
Insulation-Nylon, UL 94V-2
Terminal Body-Copper per ASTM B-152
Plating-Tin per ASTM B-545
Metallic Sleeve-Copper per ASTM B-152
Plating-Nickel per QQ-N-290 or Tin per ASTM B-545

Related Product Data
Insulation Color Code -pg. 4
Packaging Quantities -pg. 4
Performance Specifications -pgs. 4 & 5
Application Tooling -pg. 66

Wire Size Circular Mils [mm ²]	Tongue Material Thickness Max.	Stud Size	Dimensions				Terminal Insulation Color Solid/Stripe	Wire Insulation Diameter Range	Part Numbers	
			W	C Min.	E Max.	L Max.			Loose Piece	Tape Mounted
26 304 [0.15]	.029 0.74	2 M2	.203 5.16	.211 5.36	.632 16.05	.739 18.77	Yellow/Black	.026-.055 0.66-1.40	53078'	—
		4	.203 5.16	.211 5.36	.632 16.05	.736 18.69	Yellow/Black	.026-.055 0.66-1.40	53049'	—
		6 M3.5	.250 6.35	.243 6.17	.664 16.87	.792 20.12	Yellow/Black	.026-.055 0.66-1.40	53050'	—
		8 M4	.281 7.14	.250 6.35	.671 17.04	.814 20.68	Yellow/Black	.026-.055 0.66-1.40	53051'	—
		10	.312 7.92	.281 7.14	.702 17.83	.863 21.92	Yellow/Black	.026-.055 0.66-1.40	53052'	—
24 475 [0.24]	.020 0.51	4	.203 5.16	.211 5.36	.587 14.91	.691 17.55	Yellow/Blue	.031-.055 0.79-1.40	2-323914-2	—
		6 M3.5	.250 6.35	.281 7.14	.657 16.69	.785 19.94	Yellow/Blue	.031-.055 0.79-1.40	2-326875-4	—
		8 M4	.250 6.35	.281 7.14	.657 16.69	.785 19.94	Yellow/Blue	.031-.055 0.79-1.40	2-323916-3	—
		10	.250 6.35	.281 7.14	.657 16.69	.785 19.94	Yellow/Blue	.031-.055 0.79-1.40	2-326875-5	—
		2 M2	.203 5.16	.211 5.36	.632 16.05	.739 18.77	Yellow/Blue	.031-.055 0.79-1.40	53053'	—
22 754 [0.38]	.029 0.74	4	.203 5.16	.211 5.36	.632 16.05	.736 18.69	Yellow/Blue	.031-.055 0.79-1.40	53054'	—
		6 M3.5	.250 6.35	.243 6.17	.664 16.87	.792 20.12	Yellow/Blue	.031-.055 0.79-1.40	53055'	53055-1'
		8 M4	.281 7.14	.250 6.35	.671 17.04	.814 20.68	Yellow/Blue	.031-.055 0.79-1.40	53056'	—
		10	.312 7.92	.281 7.14	.702 17.83	.860 21.84	Yellow/Blue	.031-.055 0.79-1.40	53057'	53057-1'
		2 M2	.182 4.62	.172 4.37	.638 16.21	.731 18.57	Red/Green	.038-.110 0.97-2.79	52307	—
22 754 [0.38]	.033 0.84	4	.218 5.54	.156 3.96	.622 15.80	.734 18.64	Red/Green	.038-.110 0.97-2.79	52273*	—
		6 M3.5	.218 5.54	.156 3.96	.622 15.80	.734 18.64	Red/Green	.038-.110 0.97-2.79	2-36149-3*	—
			.250 6.35	.250 6.35	.716 18.19	.844 21.44	Red/Green	.038-.110 0.97-2.79	51863-2*	51863-5
		8 M4	.312 7.92	.281 7.14	.747 18.97	.906 23.01	Red/Green	.038-.110 0.97-2.79	1-320551-2*	1-320551-5
		10	.312 7.92	.281 7.14	.747 18.97	.906 23.01	Red/Green	.038-.110 0.97-2.79	2-36153-3*	2-36153-6
		1/4 M6	.469 11.91	.437 11.10	.903 22.94	1.140 28.96	Red/Green	.038-.110 0.97-2.79	2-320571-3	—
		5/16 M8	.469 11.91	.437 11.10	.903 22.94	1.140 28.96	Red/Green	.038-.110 0.97-2.79	2-320572-2	—
3/8	.531 13.49	.546 13.87	1.012 25.70	1.280 32.51	Red/Green	.038-.110 0.97-2.79	2-320573-1	—		
1/2 M12	.713 18.11	.530 13.46	.996 25.30	1.355 34.42	Red/Green	.038-.110 0.97-2.79	2-328975-1	—		

*Available in small packaging quantities.

Note: "C" dimension applies from edge of metal wire barrel to center of stud hole.

'Must be crimped with 22-18 or 22-16 PIDG (red) Tooling.

PIDG Terminals and Splices (Continued)

Ring Tongue Terminals
(Insulation Restricting)

(Continued)

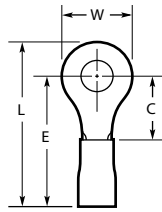

Material

Insulation-Nylon, UL 94V-2

Terminal Body-Copper per ASTM B-152

Plating-Tin per ASTM B-545

Metallic Sleeve-Copper per ASTM B-152

Plating-Nickel per QQ-N-290 or Tin per ASTM B-545

Related Product Data

Insulation Color Code -pg. 4

Packaging Quantities -pg. 4

Performance Specifications -pgs. 4 & 5

Application Tooling-pg. 66

Wire Size Circular Mills [mm ²]	Tongue Material Thickness Max.	Stud Size	Dimensions				Terminal Insulation Color Solid/Stripe	Wire Insulation Diameter Range	Part Numbers			
			W	C Min.	E Max.	L Max.			Loose Piece	Tape Mounted		
20 1,186 [0.60]	.033 0.84	2 M2	.182 4.62	.172 4.37	.638 16.21	.731 18.57	Red/Red	.046-.110 1.17-2.79	52307-1	—		
		4	.218 5.54	.156 3.96	.622 15.80	.734 18.64	Red/Red	.046-.110 1.17-2.79	52273-1*	—		
		6 M3.5	.218 5.54	.156 3.96	.622 15.80	.734 18.64	Red/Red	.046-.110 1.17-2.79	2-36149-4*	—		
			.250 6.35	.250 6.35	.716 18.19	.844 21.44	Red/Red	.046-.110 1.17-2.79	51863-3	51863-6		
		8 M4	.312 7.92	.281 7.14	.747 18.97	.906 23.01	Red/Red	.046-.110 1.17-2.79	1-320551-3*	1-320551-7		
		10	.312 7.92	.281 7.14	.747 18.97	.906 23.01	Red/Red	.046-.110 1.17-2.79	2-36153-4*	—		
		1/4 M6	.469 11.91	.437 11.10	.903 22.94	1.140 28.96	Red/Red	.046-.110 1.17-2.79	2-320571-4	—		
		5/16 M8	.469 11.91	.437 11.10	.903 22.94	1.140 28.96	Red/Red	.046-.110 1.17-2.79	2-320572-3	—		
		3/8	.531 13.49	.546 13.87	1.012 25.70	1.280 32.51	Red/Red	.046-.110 1.17-2.79	2-320573-2	—		
		1/2 M12	.713 18.11	.530 13.46	.996 25.30	1.355 34.42	Red/Red	.046-.110 1.17-2.79	2-328975-2	—		
		18 1,900 [0.96]	.033 0.84	4	.218 5.54	.156 3.96	.622 15.80	.734 18.64	Red/White	.056-.110 1.42-2.79	52273-2*	—
				6 M3.5	.218 5.54	.156 3.96	.622 15.80	.734 18.64	Red/White	.056-.110 1.42-2.79	2-36149-5*	—
.250 6.35	.250 6.35				.716 18.19	.844 21.44	Red/White	.056-.110 1.42-2.79	51863-4*	51863-7		
8 M4	.312 7.92			.281 7.14	.747 18.97	.906 23.01	Red/White	.056-.110 1.42-2.79	1-320551-4*	1-320551-8		
10	.312 7.92			.281 7.14	.747 18.97	.906 23.01	Red/White	.056-.110 1.42-2.79	2-36153-5*	2-36153-9		
1/4 M6	.469 11.91			.437 11.10	.903 22.94	1.140 28.96	Red/White	.056-.110 1.42-2.79	2-320571-5	—		
5/16 M8	.469 11.91			.437 11.10	.903 22.94	1.140 28.96	Red/White	.056-.110 1.42-2.79	2-320572-4	2-320574-7		
3/8	.531 13.49			.546 13.87	1.012 25.70	1.280 32.51	Red/White	.056-.110 1.42-2.79	2-320573-3	—		
1/2 M12	.713 18.11			.530 13.46	.996 25.30	1.355 34.42	Red/White	.056-.110 1.42-2.79	2-328975-3	—		
16 2,800 [1.42]	.033 0.84			4	.250 6.35	.171 4.34	.637 16.18	.765 19.43	Blue/Blue	.063-.130 1.60-3.30	52274	—
				6 M3.5	.250 6.35	.171 4.34	.637 16.18	.765 19.43	Blue/Blue	.063-.130 1.60-3.30	2-320561-3*	2-320561-5
					.312 7.92	.281 7.14	.747 18.97	.906 23.01	Blue/Blue	.063-.130 1.60-3.30	51864-6*	1-51864-2
		8 M4	.312 7.92	.281 7.14	.747 18.97	.906 23.01	Blue/Blue	.063-.130 1.60-3.30	1-51864-0*	1-51864-6		
		10	.312 7.92	.281 7.14	.747 18.97	.906 23.01	Blue/Blue	.063-.130 1.60-3.30	51864-7*	—		
		1/4 M6	.469 11.91	.437 11.10	.903 22.94	1.140 28.96	Blue/Blue	.063-.130 1.60-3.30	2-320563-3	—		
		5/16 M8	.469 11.91	.437 11.10	.903 22.94	1.140 28.96	Blue/Blue	.063-.130 1.60-3.30	2-320575-2	—		
		3/8	.531 13.49	.546 13.87	1.012 25.70	1.280 32.51	Blue/Blue	.063-.130 1.60-3.30	2-320564-1	—		
		1/2 M12	.713 18.11	.530 13.46	.996 25.30	1.355 34.42	Blue/Blue	.063-.130 1.60-3.30	2-328976-1	—		

*Available in small packaging quantities.

Note: "C" dimension applies from edge of metal wire barrel to center of stud hole.

PIDG Terminals and Splices (Continued)

Ring Tongue Terminals
(Insulation Restricting)

(Continued)

Wire Size Circular Mils [mm ²]	Tongue Material Thickness Max.	Stud Size	Dimensions				Terminal Insulation Color Solid/Stripe	Wire Insulation Diameter Range	Part Numbers	
			W	C Min.	E Max.	L Max.			Loose Piece	Tape Mounted
14 4,234 [2.15]	.033 0.84	4	.250 6.35	.171 4.34	.637 16.18	.765 19.43	Blue/Green	.078-.130 1.98-3.30	52274-1	—
		6 M3.5	.250 6.35	.171 4.34	.637 16.18	.765 19.43	Blue/Green	.078-.130 1.98-3.30	2-320561-4	—
			.312 7.92	.281 7.14	.747 18.97	.906 23.01	Blue/Green	.078-.130 1.98-3.30	51864-8*	1-51864-4
		8 M4	.312 7.92	.281 7.14	.747 18.97	.906 23.01	Blue/Green	.078-.130 1.98-3.30	1-51864-1*	1-51864-7
		10	.312 7.92	.281 7.14	.747 18.97	.906 23.01	Blue/Green	.078-.130 1.98-3.30	51864-9*	1-51864-5
		1/4 M6	.469 11.91	.437 11.10	.903 22.94	1.140 28.96	Blue/Green	.078-.130 1.98-3.30	2-320563-4	—
		5/16 M8	.469 11.91	.437 11.10	.903 22.94	1.140 28.96	Blue/Green	.078-.130 1.98-3.30	2-320575-3	—
		3/8	.531 13.49	.546 13.87	1.012 25.70	1.280 32.51	Blue/Green	.078-.130 1.98-3.30	2-320564-2	—
		1/2 M12	.713 18.11	.530 13.46	.996 25.30	1.355 34.42	Blue/Green	.078-.130 1.98-3.30	2-328976-2	—
		12 6,654 [3.37]	.042 1.07	6 M3.5	.375 9.53	.302 7.67	.958 24.33	1.148 29.16	Yellow/Yellow	.095-.200 2.41-5.08
8 M4	.375 9.53			.302 7.67	.958 24.33	1.148 29.16	Yellow/Yellow	.095-.200 2.41-5.08	2-320568-2*	—
10	.375 9.53			.302 7.67	.958 24.33	1.148 29.16	Yellow/Yellow	.095-.200 2.41-5.08	2-36161-3*	—
1/4 M6	.531 13.49			.468 11.89	1.124 28.55	1.392 35.36	Yellow/Yellow	.095-.200 2.41-5.08	2-320569-5	—
5/16 M8	.531 13.49			.468 11.89	1.124 28.55	1.392 35.36	Yellow/Yellow	.095-.200 2.41-5.08	2-320576-2	—
3/8	.593 15.06			.531 13.49	1.187 30.15	1.486 37.74	Yellow/Yellow	.095-.200 2.41-5.08	2-320577-1	—
1/2 M12	.715 18.16			.474 12.04	1.130 28.70	1.490 37.85	Yellow/Yellow	.095-.200 2.41-5.08	52077-1	—
6 M3.5	.375 9.53			.302 7.67	.958 24.33	1.148 29.16	Yellow/Brown	.119-.200 3.02-5.08	2-36161-6	3-36161-0
8 M4	.375 9.53			.302 7.67	.958 24.33	1.148 29.16	Yellow/Brown	.119-.200 3.02-5.08	2-320568-3*	—
10	.375 9.53			.302 7.67	.958 24.33	1.148 29.16	Yellow/Brown	.119-.200 3.02-5.08	2-36161-4	2-36161-8
10 12,066 [6.11]	.042 1.07	1/4 M6	.531 13.49	.468 11.89	1.124 28.55	1.392 35.36	Yellow/Brown	.119-.200 3.02-5.08	2-320569-6	2-320569-8
		5/16 M8	.531 13.49	.468 11.89	1.124 28.55	1.392 35.36	Yellow/Brown	.119-.200 3.02-5.08	2-320576-3	—
		3/8	.593 15.06	.531 13.49	1.187 30.15	1.486 37.74	Yellow/Brown	.119-.200 3.02-5.08	2-320577-2	—
		1/2 M12	.715 18.16	.474 12.04	1.130 28.70	1.490 37.85	Yellow/Brown	.119-.200 3.02-5.08	52077-2	—

*Available in small packaging quantities.

Note: "C" dimension applies from edge of metal wire barrel to center of stud hole.

PIDG Terminals and Splices (Continued)

Ring Tongue Terminals
90° Bend

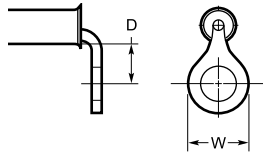

Material
Insulation-Vinyl, UL 94V-0
Terminal Body and Metallic Sleeve-Copper per ASTM B-152
Plating-Tin per ASTM B-545

Related Product Data
Insulation Color Code-pg. 4
Packaging Quantities-pg. 4
Performance Specifications-pgs. 4 & 5
Application Tooling-pg. 66

	Wire Size Cicular Mils [mm ²]	Tongue Material Thickness Max.	Stud Size	Dimensions		Terminal Insulation Color	Wire Insulation Diameter Max.	Part Number
				W	D Min.			Loose Piece
Vinyl	22-16 509-3,260 [0.26-1.65]	.033 0.84	10	.312 7.92	.157 3.99	Red	.140 3.56	55148-1
Nylon	12-10 5,180-13,100 [2.62-6.64]	.040 1.02	6	.375 9.53	.206 5.23	Yellow	.250 6.35	696020-1

PIDG Terminals and Splices (Continued)

Rectangular Tongue Terminals

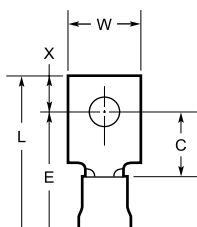

Material

Insulation -Nylon except where noted.

Terminal Body and Metallic Sleeve -Copper per ASTM B-152 except where noted.

Plating -Tin per ASTM B-545

Related Product Data

Insulation Color Code -pg. 4

Packaging Quantities -pg. 4

Performance Specifications - pgs. 4 & 5

Application Tooling -pg. 66

Wire Size Circular Mils [mm ²]	Tongue Material Thickness Max.	Stud Size	Dimensions					Terminal Insulation Color	Wire Insulation Diameter Max.	Part Numbers			
			W	C Min.	E Max.	L Max.	X			Loose Piece	Tape Mounted		
26-22 202-810 [0.10-0.41]	.020 0.51	2 M2	.182 4.62	.211 5.36	.542 13.77	.647 16.43	.100 2.54	Yellow	.082 2.08	321206 ²	—		
		6 M3.5	.277 7.04	.308 7.82	.643 16.33	.783 19.89	.130 3.30	Yellow	.082 2.08	330250	—		
		2 M2	.182 4.62	.203 5.16	.607 15.42	.727 18.47	.115 2.92	Red	.125 3.18	325148	—		
		4	.237 6.02	.237 6.02	.643 16.33	.796 20.22	.143 3.63	Red	.140 3.56	2-327968-1	—		
			.237 6.02	.404 10.26	.810 20.57	1.015 25.78	.195 4.95	Red	.140 3.56	327962	—		
		5 M3	.250 6.35	.187 4.75	.591 15.01	.736 18.69	.140 3.56	Red	.140 3.56	55777-1	—		
			.277 7.04	.277 7.04	.702 17.83	.855 21.72	.143 3.63	Red	.140 3.56	2-327950-1	—		
		22-16 509-3,260 [0.26-1.65]	.033 0.84	6 M3.5	.237 6.02	.404 10.26	.810 20.57	1.015 25.78	.195 4.95	Red	.140 3.56	2-327956-1	—
					.250 6.35	.312 7.92	.716 18.19	.846 21.49	.125 3.18	Red	.125 3.18	320629	2-320629-1
				8 M4	.250 6.35	.312 7.92	.716 18.19	.846 21.49	.125 3.18	Red	.140 3.56	33476*	2-33476-1
					.302 7.67	.465 11.81	.872 22.15	1.109 28.17	.227 5.77	Red	.140 3.56	2-327938-1	2-327938-2
				10	.302 7.67	.465 11.81	.872 22.15	1.109 28.17	.227 5.77	Red	.140 3.56	327944*	2-327944-2
.390 9.91	.621 15.77				1.039 26.39	1.359 34.52	.310 7.87	Red	.140 3.56	327932	—		
16-14 2,050-5,180 [1.04-2.62]	.033 0.84	4	.312 7.92	.281 7.14	.685 17.40	.893 22.68	.203 5.16	Red	.140 3.56	320209*	—		
			.237 6.02	.237 6.02	.643 16.33	.796 20.22	.143 3.63	Blue	.150 3.81	2-327970-4	—		
		5 M3	.237 6.02	.404 10.26	.810 20.57	1.015 25.78	.195 4.95	Blue	.150 3.81	2-327964-4	—		
			.244 6.20	.312 7.92	.716 18.19	.856 21.74	.125 3.18	Blue	.150 3.81	—	55694-1 ¹		
		10	.277 7.04	.277 7.04	.702 17.83	.855 21.72	.143 3.63	Blue	.150 3.81	2-327952-2	—		

*Available in small packaging quantities.

¹Insulation - Vinyl

²Terminal Body - Brass per MIL-C-50.

Note: "C" dimension applies from edge of metal wire barrel to center of stud hole.

PIDG Terminals and Splices (Continued)

Rectangular Tongue Terminals

(Continued)

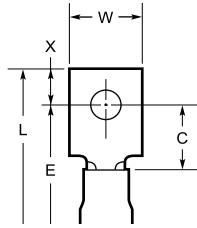

Material

Insulation -Nylon except where noted.

Terminal Body and Metallic Sleeve -Copper per ASTM B-152

Plating -Tin per ASTM B-545

Related Product Data

Insulation Color Code -pg. 4

Packaging Quantities -pg. 4

Performance Specifications -pgs. 4 & 5

Application Tooling - pg. 66

Wire Size Circular Mils [mm ²]	Tongue Material Thickness Max.	Stud Size	Dimensions					Terminal Insulation Color	Wire Insulation Diameter Max.	Part Numbers			
			W	C Min.	E Max.	L Max.	X			Loose Piece	Tape Mounted		
16-14 2,050-5,180 [1.04-2.62]	.033 0.84	6 M3.5	.237 6.02	.404 10.26	.810 20.57	1.015 25.78	.195 4.95	Blue	.150 3.81	2-327958-4	—		
			.237 6.02	.404 10.26	.810 20.57	1.015 25.78	.195 4.95	Blue	.170 4.32	2-327958-1	—		
			.244 6.20	.312 7.92	.716 18.19	.856 21.74	.125 3.18	Blue	.150 3.81	33172	—		
			.244 6.20	.312 7.92	.716 18.19	.856 21.74	.125 3.18	Blue	.170 4.32	33173*	—		
			.296 7.52	.203 5.16	.607 15.42	.752 19.10	.140 3.56	Blue	.150 3.81	33168	—		
			.302 7.67	.465 11.81	.872 22.15	1.109 28.17	.227 5.77	Blue	.150 3.81	2-327940-4	—		
		8 M4	.244 6.20	.312 7.92	.716 18.19	.856 21.74	.125 3.18	Blue	.170 4.32	35279	—		
			.296 7.52	.343 8.71	.747 18.97	.939 23.85	.187 4.75	Blue	.170 4.32	321283*	—		
			.302 7.67	.465 11.81	.872 22.15	1.109 28.17	.227 5.77	Blue	.150 3.81	2-327946-4	—		
			.390 9.91	.621 15.77	1.039 26.39	1.359 34.52	.310 7.87	Blue	.150 3.81	2-327934-2	—		
			10	.312 7.92	.281 7.14	.685 17.40	.940 23.88	.250 6.35	Blue	.170 4.32	324603	—	
				.237 6.02	.237 6.02	.831 21.11	.984 24.99	.143 3.63	Yellow	.230 5.84	327972	—	
		12-10 5,180-13,100 [2.62-6.64]	.042 1.07	4	.237 6.02	.404 10.26	.998 25.35	1.203 30.56	.195 4.95	Yellow	.230 5.84	327966	—
					.277 7.04	.277 7.04	.889 22.58	1.042 26.47	.143 3.63	Yellow	.230 5.84	327954	2-327954-2
6 M3.5	.237 6.02			.404 10.26	.998 25.35	1.203 30.56	.195 4.95	Yellow	.230 5.84	2-327960-1-2-327960-2	—		
	.250 6.35			.302 7.67	.893 22.68	1.085 27.56	.187 4.75	Yellow	.230 5.84	329697	—		
	.290 7.37			.218 5.54	.809 20.55	.954 24.23	.140 3.56	Yellow	.230 5.84	34512	—		
	.302 7.67			.465 11.81	1.044 26.52	1.281 32.54	.227 5.77	Yellow	.230 5.84	327942	—		
	8 M4			.302 7.67	.465 11.81	1.044 26.52	1.281 32.54	.227 5.77	Yellow	.230 5.84	327948	—	
				.302 7.67	.465 11.81	1.077 27.36	1.247 31.67	.160 4.06	Yellow	.230 5.84	331268	2-331268-1	
	.390 9.91			.621 15.77	1.211 30.76	1.531 38.89	.310 7.87	Yellow	.230 5.84	327936	—		

*Available in small packaging quantities.

Note: "C" dimension applies from edge of metal wire barrel to center of stud hole.

PIDG Terminals and Splices (Continued)

Rectangular Tongue Terminals

(Continued)

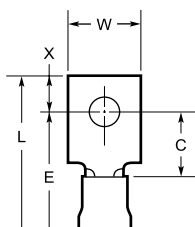

Material

Insulation -Nylon, UL 94V-2

Terminal Body -Copper per ASTM B-152

Plating -Tin per ASTM B-545

Metallic Sleeve -Copper per ASTM B-152

Plating - Nickel per QQ-N-290

Related Product Data

Insulation Color Code -pg. 4

Packaging Quantities -pg. 4

Performance Specifications -pgs. 4 & 5

Application Tooling -pg. 66

Wire Size Circular Mils [mm ²]	Tongue Material Thickness Max.	Stud Size	Dimensions					Terminal Insulation Color Solid/Stripe	Wire Insulation Diameter Range	Part Numbers	
			W	C Min.	E Max.	L Max.	X			Loose Piece	Tape Mounted
24 475 [0.24]	.020 0.51	6 M3.5	.312 7.92	.308 7.82	.683 17.35	.875 22.23	.187 4.75	Yellow/Blue	.031-.055 0.79-1.40	2-326876-2	
10 12,066 [6.11]	.042 1.07	5 M3	.277 7.04	.277 7.04	.934 23.72	1.087 27.61	.143 3.63	Yellow/Brown	.119-.200 3.02-5.08	53912-2	
		8 M4	.390 9.91	.621 15.77	1.276 32.41	1.596 40.54	.310 7.87	Yellow/Brown	.119-.200 3.02-5.08	53914-2	

Note: "C" dimension applies from edge of metal wire barrel to center of stud hole.

Spade Tongue Terminals

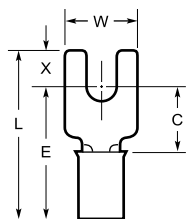

Material

Insulation -Nylon, UL 94V-2

Terminal Body and Metallic Sleeve -Copper per ASTM B-152

Plating -Tin per ASTM B-545

Related Product Data

Insulation Color Code -pg. 4

Packaging Quantities -pg. 4

Performance Specifications -pgs. 4 & 5

Application Tooling -pg. 66

Wire Size Circular Mils [mm ²]	Tongue Material Thickness Max.	Stud Size	Dimensions					Terminal Insulation Color	Wire Insulation Diameter Max.	Part Numbers	
			W	C Min.	E Max.	L Max.	X			Loose Piece	Tape Mounted
26-24 238-475 [0.12-0.24]	.029 0.74	6 M3.5	.250 6.35	.211 5.36	.632 16.05	.709 18.01	.072 1.83	Yellow	.095 2.41	—	53115-2
26-22 202-810 [0.10-0.41]	.020 0.51	0	.125 3.18	.078 1.98	.409 10.39	.476 12.09	.062 1.57	Yellow	.082 2.08	322001	—
		4	.203 5.16	.211 5.36	.542 13.77	.627 15.93	.076 1.93	Yellow	.082 2.08	321035*	2-321035-1
22-16 509-3,260 [0.26-1.65]	.033 0.84	2 M2	.182 4.62	.203 5.16	.607 15.42	.727 18.47	.115 2.92	Red	.140 3.56	328394*	2-328394-1
			4	.218 5.54	.156 3.96	.560 14.22	.674 17.12	.109 2.77	Red	.125 3.18	1-327717-0
		4		.218 5.54	.156 3.96	.560 14.22	.674 17.12	.109 2.77	Red	.140 3.56	327717*
			6 M3.5	.250 6.35	.312 7.92	.716 18.19	.846 21.49	.125 3.18	Red	.140 3.56	34541*
		6 M3.5		.297 7.54	.203 5.16	.607 15.42	.753 19.13	.141 3.58	Red	.125 3.18	34080*
			6 M3.5	.297 7.54	.203 5.16	.607 15.42	.753 19.13	.141 3.58	Red	.140 3.56	326861*
		6 M3.5		.344 8.74	.218 5.54	.622 15.80	.783 19.89	.156 3.96	Red	.125 3.18	32403
			6 M3.5	.344 8.74	.218 5.54	.622 15.80	.783 19.89	.156 3.96	Red	.140 3.56	32404
		8 M4		.375 9.53	.312 7.92	.716 18.19	.908 23.06	.187 4.75	Red	.125 3.18	32050*
			8 M4	.375 9.53	.312 7.92	.716 18.19	.908 23.06	.187 4.75	Red	.140 3.56	32053*
		10		.375 9.53	.312 7.92	.716 18.19	.908 23.06	.187 4.75	Red	.125 3.18	32051*
			10	.375 9.53	.312 7.92	.716 18.19	.908 23.06	.187 4.75	Red	.140 3.56	32054*

*Available in small packaging quantities.

Note: "C" dimension applies from edge of metal wire barrel to center of stud hole.

PIDG Terminals and Splices (Continued)

Spade Tongue Terminals

(Continued)

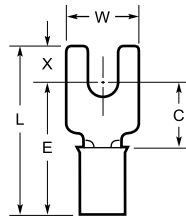

Material

Insulation -Nylon, UL 94V-2

Terminal Body and Metallic Sleeve -Copper per ASTM B-152

Plating -Tin per ASTM B-545

Related Product Data

Insulation Color Code -pg. 4

Packaging Quantities -pg. 4

Performance Specifications -pgs. 4 & 5

Application Tooling -pg. 66

Wire Size Circular Mills [mm ²]	Tongue Material Thickness Max.	Stud Size	Dimensions					Terminal Insulation Color	Wire Insulation Diameter Max.	Part Numbers			
			W	C Min.	E Max.	L Max.	X			Loose Piece	Tape Mounted		
16-14 2,050-5,180 [1.04-2.62]	.033 0.84	6 M3.5	.244 6.20	.312 7.92	.716 18.19	.846 21.49	.125 3.18	Blue	.170 4.32	328281*	1-328281-1		
			.297 7.54	.203 5.16	.607 15.42	.753 19.13	.141 3.58	Blue	.170 4.32	35559*	2-35559-1		
			.385 9.78	.312 7.92	.716 18.19	.908 23.06	.187 4.75	Blue	.170 4.32	32058*	—		
		8 M4	.297 7.54	.203 5.16	.607 15.42	.753 19.13	.141 3.58	Blue	.170 4.32	321233*	2-321233-1		
			.312 7.92	.375 9.53	.779 19.79	1.034 26.26	.250 6.35	Blue	.170 4.32	325199	—		
			.385 9.78	.312 7.92	.716 18.19	.908 23.06	.187 4.75	Blue	.150 3.81	32056*	2-32056-1		
			.385 9.78	.312 7.92	.716 18.19	.908 23.06	.187 4.75	Blue	.170 4.32	32059*	2-32059-1		
			10	.385 9.78	.312 7.92	.716 18.19	.908 23.06	.187 4.75	Blue	.150 3.81	32057	—	
				.385 9.78	.312 7.92	.716 18.19	.908 23.06	.187 4.75	Blue	.170 4.32	32060*	2-32060-1	
		12-10 5,180-13,100 [2.62-6.64]	.042 1.07	6 M3.5	.290 7.37	.218 5.54	.809 20.55	.954 24.23	.140 3.56	Yellow	.230 5.84	322985*	1-322985-0
					.312 7.92	.296 7.52	.887 22.53	1.095 27.81	.203 5.16	Yellow	.230 5.84	326859*	2-326859-1
				8 M4	.312 7.92	.468 11.89	1.059 26.90	1.314 33.38	.250 6.35	Yellow	.230 5.84	325197	—
.406 10.31	.296 7.52				.887 22.53	1.095 27.81	.203 5.16	Yellow	.230 5.84	32588*	2-32588-1		
.406 10.31	.296 7.52				.887 22.53	1.095 27.81	.203 5.16	Yellow	.250 6.35	35152*	2-35152-1		
10	.406 10.31				.296 7.52	.887 22.53	1.095 27.81	.203 5.16	Yellow	.230 5.84	32589*	2-32589-1	

*Available in small packaging quantities.

Note: "C" dimension applies from edge of metal wire barrel to center of stud hole.

PIDG Terminals and Splices (Continued)

Flanged Spade Tongue Terminals

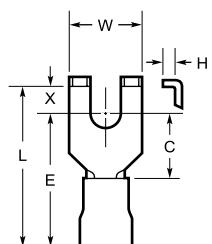

Material
Insulation -Nylon, UL 94V-2
Terminal Body and Metallic Sleeve -Copper per ASTM B-152
Plating -Tin per ASTM B-545

Related Product Data
Insulation Color Code -pg. 4
Packaging Quantities -pg. 4
Performance Specifications -pgs. 4 & 5
Application Tooling -pg. 66

Wire Size Circular Mills [mm ²]	Tongue Material Thickness Max.	Stud Size	Dimensions						Terminal Insulation Color	Wire Insulation Diameter Max.	Part Numbers			
			W	C Min.	C Max.	E Max.	L Max.	X Min.			H Min.	Loose Piece	Tape Mounted	
26-22 202-810 [0.10-0.41]	.020 0.51	2 M2	.182 4.62	.203 5.16	.534 13.56	.649 16.48	.110 2.79	.026 0.66	Yellow	.082 2.08	324597*	2-324597-1		
		4	.193 4.90	.203 5.16	.534 13.56	.649 16.48	.110 2.79	.026 0.66	Yellow	.082 2.08	52369*	52369-1		
		6 M3.5	.250 6.35	.203 5.16	.534 13.56	.649 16.48	.110 2.79	.026 0.66	Yellow	.082 2.08	51874*	51874-1		
22-16 509-3,260 [0.26-1.65]	.033 0.84	2 M2	.182 4.62	.203 5.16	.607 15.42	.727 18.47	.115 2.92	.041 1.04	Red	.125 3.18	2-324608-2	—		
			.182 4.62	.203 5.16	.607 15.42	.727 18.47	.115 2.92	.041 1.04	Red	.140 3.56	324608*	2-324608-1		
		6 M3.5	.250 6.35	.203 5.16	.607 15.42	.737 18.72	.125 3.18	.046 1.17	Red	.125 3.18	322777*	2-322777-1		
			.265 6.73	.203 5.16	.607 15.42	.737 18.72	.125 3.18	.046 1.17	Red	.140 3.56	322426	—		
		6 M3.5	.296 7.52	.203 5.16	.607 15.42	.737 18.72	.125 3.18	.046 1.17	Red	.125 3.18	32561*	2-32561-1		
			.296 7.52	.203 5.16	.607 15.42	.737 18.72	.125 3.18	.046 1.17	Red	.140 3.56	32562*	2-32562-1		
		8 M4	.328 8.33	.203 5.16	.607 15.42	.737 18.72	.125 3.18	.046 1.17	Red	.140 3.56	324557	2-324557-1		
			.296 7.52	.203 5.16	.607 15.42	.737 18.72	.125 3.18	.046 1.17	Red	.140 3.56	2-32562-2	2-32562-3		
		10	.416 10.57	.250 6.35	.654 16.61	.830 21.08	.171 4.34	.062 1.57	Red	.125 3.18	32497	2-32497-1		
			.416 10.57	.250 6.35	.654 16.61	.830 21.08	.171 4.34	.062 1.57	Red	.140 3.56	32498*	2-32498-1		
		16-14 2,050-5,180 [1.04-2.62]	.033 0.84	6 M3.5	.294 7.47	.203 5.16	.607 15.42	.737 18.72	.125 3.18	.047 1.19	Blue	.150 3.81	2-320861-2	2-320861-3
					.294 7.47	.203 5.16	.607 15.42	.737 18.72	.125 3.18	.047 1.19	Blue	.170 4.32	320861*	2-320861-1
8 M4	.328 8.33			.203 5.16	.607 15.42	.737 18.72	.125 3.18	.047 1.19	Blue	.170 4.32	324567*	—		
	.294 7.47			.203 5.16	.607 15.42	.737 18.72	.125 3.18	.047 1.19	Blue	.170 4.32	320862*	2-320862-1		
10	.416 10.57			.250 6.35	.654 16.61	.830 21.08	.171 4.34	.062 1.57	Blue	.150 3.81	33155*	—		
	.416 10.57			.250 6.35	.654 16.61	.830 21.08	.171 4.34	.062 1.57	Blue	.170 4.32	33156	2-33156-1		
12-10 5,180-13,100 [2.62-6.64]	.042 1.07	6 M3.5	.294 7.47	.203 5.16	.607 15.42	.737 18.72	.125 3.18	.052 1.32	Yellow	.230 5.84	320863*	2-320863-2		
			.296 7.52	.250 6.35	.841 21.36	1.017 25.83	.171 4.34	.052 1.32	Yellow	.230 5.84	324577-0	—		
		8 M4	.296 7.52	.250 6.35	.841 21.36	1.017 25.83	.171 4.34	.052 1.32	Yellow	.250 6.35	325150*	—		
			.328 8.33	.250 6.35	.841 21.36	1.017 25.83	.171 4.34	.052 1.32	Yellow	.230 5.84	324587	—		
		10	.416 10.57	.250 6.35	.841 21.36	1.017 25.83	.171 4.34	.052 1.32	Yellow	.230 5.84	32510*	2-32510-1		
			.416 10.57	.250 6.35	.841 21.36	1.017 25.83	.171 4.34	.052 1.32	Yellow	.230 5.84	326865	2-326865-1		
10	.416 10.57	.250 6.35	.841 21.36	1.017 25.83	.171 4.34	.052 1.32	Yellow	.250 6.35	324015*	2-324015-1				
	.416 10.57	.250 6.35	.841 21.36	1.017 25.83	.171 4.34	.052 1.32	Yellow	.250 6.35	324015*	2-324015-1				

*Available in small packaging quantities.

Note: "C" dimension applies from edge of metal wire barrel to center of stud hole.

PIDG Terminals and Splices

PIDG Terminals and Splices (Continued)

**Short Spring Spade
Tongue Terminals**

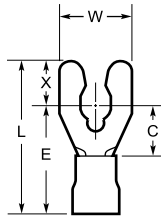

Material
Insulation -Nylon, UL 94V-2
Terminal Body -Phosphor Bronze per ASTM B-139
Metallic Sleeve -Copper per ASTM B-152
Plating -Tin per ASTM B-545

Related Product Data
Insulation Color Code -pg. 4
Packaging Quantities -pg. 4
Performance Specifications -pgs. 4 & 5
Application Tooling -pg. 66

Wire Size Circular Mills [mm ²]	Tongue Material Thickness Max.	Stud Size	Dimensions					Terminal Insulation Color	Wire Insulation Diameter Max.	Part Numbers			
			W	C Min.	E Max.	L Max.	X			Loose Piece	Tape Mounted		
26-22 202-810 [0.10-0.41]	.020 0.51	2 M2	.171 4.34	.206 5.23	.537 13.64	.651 16.54	.109 2.77	Yellow	.082 2.08	52921*	52921-1		
		4	.203 5.16	.219 5.56	.550 13.97	.695 17.65	.140 3.56	Yellow	.082 2.08	52922*	52922-1		
		5 M3	.250 6.35	.203 5.16	.534 13.56	.679 17.25	.140 3.56	Yellow	.082 2.08	52923	52923-1		
		6 M3.5	.250 6.35	.203 5.16	.534 13.56	.679 17.25	.140 3.56	Yellow	.082 2.08	52924*	52924-1		
		8 M4	.375 9.53	.281 7.14	.612 15.54	.787 19.99	.170 4.32	Yellow	.082 2.08	52925	52925-1		
		4	.203 5.16	.250 6.35	.654 16.61	.799 20.29	.140 3.56	Red	.125 3.18	52927*	52927-1		
		5 M3	.250 6.35	.250 6.35	.654 16.61	.799 20.29	.140 3.56	Red	.125 3.18	52928*	52928-1		
		6 M3.5	.250 6.35	.250 6.35	.654 16.61	.799 20.29	.140 3.56	Red	.125 3.18	52929*	52929-1		
22-16 509-3,260 [0.26-1.65]	.033 0.84	8 M4	.244 6.20	.281 7.14	.725 18.42	.895 22.73	.170 4.32	Red	.140 3.56	—	55768-1		
			.375 9.53	.281 7.14	.685 17.40	.860 21.84	.170 4.32	Red	.125 3.18	52930*	52930-1		
		10	.375 9.53	.281 7.14	.685 17.40	.860 21.84	.170 4.32	Red	.140 3.56	—	52930-3		
			.406 10.31	.281 7.14	.685 17.40	.908 23.06	.218 5.54	Red	.125 3.18	52931*	52931-1		
		1/4 M6	.406 10.31	.281 7.14	.685 17.40	.908 23.06	.218 5.54	Red	.140 3.56	—	52931-3		
			.625 15.88	.343 8.71	.747 18.97	1.033 26.24	.281 7.14	Red	.125 3.18	52933*	—		
		16-14 2,050-5,180 [1.04-2.62]	.033 0.84	5 M3	.250 6.35	.250 6.35	.654 16.61	.799 20.29	.140 3.56	Blue	.170 4.32	52934*	52934-1
				6 M3.5	.250 6.35	.250 6.35	.654 16.61	.799 20.29	.140 3.56	Blue	.170 4.32	52935*	52935-1
					.250 6.35	.250 6.35	.654 16.61	.799 20.29	.140 3.56	Blue	.182 4.62	52935-2*	52935-3
				8 M4	.375 9.53	.281 7.14	.685 17.40	.860 21.84	.170 4.32	Blue	.170 4.32	52936*	52936-1
.375 9.53	.281 7.14				.685 17.40	.860 21.84	.170 4.32	Blue	.182 4.62	52936-2	52936-3		
10	.406 10.31			.281 7.14	.685 17.40	.908 23.06	.218 5.54	Blue	.170 4.32	52937*	52937-1		
	.406 10.31			.281 7.14	.685 17.40	.908 23.06	.218 5.54	Blue	.182 4.62	52937-2*	52937-3		
1/4 M6	.625 15.88			.343 8.71	.747 18.97	1.033 26.24	.281 7.14	Blue	.170 4.32	52939	—		
12-10 5,180-13,100 [2.62-6.64]	.042 1.07	5 M3	.250 6.35	.169 4.29	.770 19.56	.959 24.36	.184 4.67	Yellow	.250 6.35	52940*	52940-1		
		6 M3.5	.250 6.35	.174 4.42	.775 19.69	.959 24.36	.179 4.55	Yellow	.250 6.35	52941*	52941-1		
		8 M4	.375 9.53	.276 7.01	.877 22.28	1.052 26.72	.170 4.32	Yellow	.250 6.35	52942*	52942-1		
		10	.406 10.31	.276 7.01	.877 22.28	1.100 27.94	.218 5.54	Yellow	.250 6.35	52943*	52943-1		
		1/4 M6	.625 15.88	.338 8.59	.939 23.85	1.225 31.12	.281 7.14	Yellow	.250 6.35	52945*	—		

*Available in small packaging quantities.

Note: "C" dimension applies from edge of metal wire barrel to center of stud hole.

PIDG Terminals and Splices (Continued)

Long Spring Spade Tongue Terminals

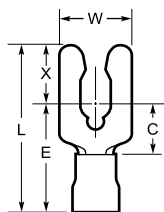

Material
Insulation -Nylon, UL 94V-2
Terminal Body -Phosphor Bronze per ASTM B-139
Metallic Sleeve -Copper per ASTM B-152
Plating -Tin per ASTM B-545

Related Product Data
Insulation Color Code -pg. 4
Packaging Quantities -pg. 4
Performance Specifications - pgs. 4 & 5
Application Tooling -pg. 66

Wire Size Circular Mils [mm ²]	Tongue Material Thickness Max.	Stud Size	Dimensions					Terminal Insulation Color	Wire Insulation Diameter Max.	Part Numbers	
			W	C Min.	E Max.	L Max.	X			Loose Piece	Tape Mounted
26-22 202-810 [0.10-0.41]	.020 0.51	6	.250	.235	.566	.847	.276	Yellow	.082 2.08	52403	52403-1
		M3.5	6.35	5.97	14.38	21.51	7.01				
22-16 509-3,260 [0.26-1.65]	.033 0.84	4	.203	.201	.615	.896	.276	Red	.125 3.18	52408	—
		M3.5	5.16	5.11	15.62	22.76	7.01				
		6	.250	.238	.652	.933	.276	Red	.125 3.18	52409*	52409-1
		M3.5	6.35	6.05	16.56	23.70	7.01				
		8	.281	.270	.684	.979	.290	Red	.125 3.18	52410*	52410-1
		M4	7.14	6.86	17.37	24.87	7.37				
10	.343	.283	.697	1.005	.303	Red	.125 3.18	52411*	52411-1		
M4	8.71	7.19	17.70	25.53	7.70						
16-14 2,050-5,180 [1.04-2.62]	.033 0.84	6	.250	.238	.652	.933	.276	Blue	.150 3.81	52420*	52420-2
		M3.5	6.35	6.05	16.56	23.70	7.01				
		8	.281	.270	.684	.979	.290	Blue	.150 3.81	52421*	—
		M4	7.14	6.86	17.37	24.87	7.37				
		10	.343	.283	.697	1.005	.303	Blue	.170 4.32	52421-1*	52421-3
		M4	8.71	7.19	17.70	25.53	7.70				
1/4	.437	.345	.759	1.102	.338	Blue	.150 3.81	52423	52423-2		
M6	11.10	8.76	19.28	27.99	8.59						
12-10 5,180-13,100 [2.62-6.64]	.042 1.07	6	.312	.242	.843	1.131	.283	Yellow	.230 5.84	52430	52430-2
		M3.5	7.92	6.15	21.41	28.73	7.19				
		8	.312	.242	.843	1.131	.283	Yellow	.250 6.35	52430-1	52430-3
		M3.5	7.92	6.15	21.41	28.73	7.19				
		8	.375	.273	.874	1.174	.295	Yellow	.250 6.35	52431-1	52431-3
		M4	9.53	6.93	22.20	29.82	7.49				
10	.375	.305	.906	1.219	.308	Yellow	.230 5.84	—	52432-2		
M4	9.53	7.75	23.01	30.96	7.82						
1/4	.437	.345	.946	1.289	.338	Yellow	.250 6.35	52432-1	52432-3		
M6	11.10	8.76	24.03	32.74	8.59						

*Available in small packaging quantities.

Note: "C" dimension applies from edge of metal wire barrel to center of stud hole.

PIDG Terminals and Splices (Continued)

Slotted Ring Tongue Terminals

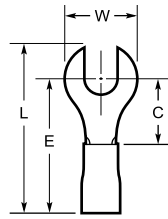

Material

Insulation -Nylon except where noted.

Terminal Body and Metallic Sleeve -Copper per ASTM B-152

Plating -Tin per ASTM B-545

Related Product Data

Insulation Color Code -pg. 4

Packaging Quantities -pg. 4

Performance Specifications - pgs. 4 & 5

Application Tooling -pg. 66

Wire Size Circular Mills [mm ²]	Tongue Material Thickness Max.	Stud Size	Dimensions				Terminal Insulation Color	Wire Insulation Diameter Max.	Part Numbers	
			W	C Min.	E Max.	L Max.			Loose Piece	Tape Mounted
26-22 202-810 [0.10-0.41]	.020 0.51	6	.250	.281	.612	.719	Yellow	.082 2.08	323011	2-323011-2
		M3.5	6.35	7.14	15.54	18.26				
22-16 509-3,260 [0.26-1.65]	.033 0.84	6	.312	.281	.685	.828	Red	.140 3.56	35216*	2-35216-1
		M3.5	7.92	7.14	17.40	21.03				
		8	.281	.250	.654	.770	Red	.140 3.56	36954*	2-36954-2
		M4	7.14	6.35	16.61	19.56				
10	.312	.281	.685	.812	Red	.125 3.18	331453	1-331453-0		
M6	7.92	7.14	17.40	20.62						
16-14 2,050-5,180 [1.04-2.62]	.033 0.84	6	.343	.281	.685	.844	Blue	.170 4.32	34406	—
		M3.5	8.71	7.14	17.40	21.44				
16-14 HD 2,050-5,180 [1.04-2.62]	.048 1.22	8	.344	.281	.685	.837	Blue	.170 4.32	35440	—
		M4	8.74	7.14	17.40	21.26				
16-14 HD 2,050-5,180 [1.04-2.62]	.048 1.22	3/8	.750	.625	1.216	1.594	Yellow/Black	.250 6.35	696077-2	696077-1
		M6	19.05	15.88	30.89	40.49				
12-10 5,180-13,100 [2.62-6.64]	.042 1.07	1/4	.531	.468	1.156	1.390	Yellow	.300 7.62	321611 ¹	—
		M6	13.49	11.89	29.36	35.31				
12-10 5,180-13,100 [2.62-6.64]	.040 1.02	3/8	.750	.625	1.216	1.594	Yellow	.250 6.35	696076-2	696076-1
		M6	19.05	15.88	30.89	40.49				

*Available in small packaging quantities.

¹Insulation — Vinyl.

Note: “C” dimension applies from edge of metal wire barrel to center of stud hole.

Hook Tongue Terminals

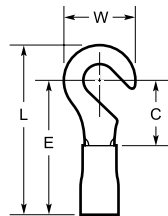

Material

Insulation -Nylon except where noted.

Terminal Body and Metallic Sleeve -Copper per ASTM B-152

Plating -Tin per ASTM B-545

Related Product Data

Insulation Color Code -pg. 4

Packaging Quantities -pg. 4

Performance Specifications - pgs. 4 & 5

Application Tooling -pg. 66

Wire Size Circular Mills [mm ²]	Tongue Material Thickness Max.	Stud Size	Dimensions				Terminal Insulation Color	Wire Insulation Diameter Max.	Part Numbers	
			W	C Min.	E Max.	L Max.			Loose Piece	Tape Mounted
22-16 509-3,260 [0.26-1.65]	0.84 .033	6	.281	.203	.607	.750	Red	.140 3.56	34313*	—
		M3.5	7.14	5.16	15.42	19.05				
22-16 509-3,260 [0.26-1.65]	0.84 .033	8	.343	.296	.705	.879	Red	.140 3.56	32456	—
		M4	8.71	7.52	17.91	22.33				
16-14 2,050-5,180 [1.04-2.62]	.033 0.84	6	.343	.281	.685	.859	Blue	.150 3.81	320381	2-320381-1
		M3.5	8.71	7.14	17.40	21.82				
16-14 2,050-5,180 [1.04-2.62]	.033 0.84	8	.343	.281	.685	.859	Blue	.170 4.32	320306*	2-320306-1
		M4	8.71	7.14	17.40	21.82				
16-14 2,050-5,180 [1.04-2.62]	.033 0.84	10	.343	.281	.685	.859	Blue	.170 4.32	35481 ¹	—
		M6	8.71	7.14	17.40	21.82				

*Available in small packaging quantities.

¹Insulation — Vinyl.

Note: “C” dimension applies from edge of metal wire barrel to center of stud hole.

PIDG Terminals and Splices (Continued)

Multiple Stud Terminals

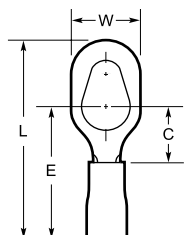

Material
Insulation -Nylon, UL 94V-2
Terminal Body -Copper per ASTM B-152
Plating -Tin per ASTM B-545
Metallic Sleeve -Copper per ASTM B-152
Plating -Nickel per QQ-N-290

Related Product Data
Insulation Color Code -pg. 4
Packaging Quantities -pg. 4
Performance Specifications -pgs. 4 & 5
Application Tooling -pg. 66

Wire Size Circular Mils [mm ²]	Tongue Material Thickness Max.	Stud Size	Dimensions				Terminal Insulation Color	Wire Insulation Diameter Max.	Part Numbers	
			W	C Min.	E Max.	L Max.			Loose Piece	Tape Mounted
22-16 509-3,260 [0.26-1.65]	.033 0.84	6-8-10	.325 8.26	.281 7.14	.685 17.40	.957 24.31	Red	.125 3.18	54771-1*	54771-2
12-10 5,180-13,100 [2.62-6.64]	.042 1.07	6-8-10	.325 8.26	.302 7.67	.893 22.68	1.165 29.59	Yellow	.230 5.84	54773-1*	—

*Available in small packaging quantities.

Note: "C" dimension applies from edge of metal wire barrel to center of stud hole.

Offset Ring Tongue Terminals

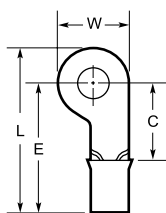

Material
Insulation -Nylon, UL 94V-2
Terminal Body and Metallic Sleeve -Copper per ASTM B-152
Plating -Tin per ASTM B-545

Related Product Data
Insulation Color Code -pg. 4
Packaging Quantities -pg. 4
Performance Specifications -pgs. 4 & 5
Application Tooling -pg. 66

Wire Size Circular Mils [mm ²]	Tongue Material Thickness Max.	Stud Size	Dimensions				Terminal Insulation Color	Wire Insulation Diameter Max.	Part Numbers
			W	C Min.	E Max.	L Max.			Loose Piece
22-16 509-3,260 [0.26-1.65]	.033 0.84	6	.375 9.53	.312 7.92	.716 18.19	.906 23.01	Red	.125 3.18	323039
		M3.5	.375 9.53	.312 7.92	.716 18.19	.906 23.01	Red	.125 3.18	324011
16-14 2,050-5,180 [1.04-2.62]	.033 0.84	6	.375 9.53	.312 7.92	.716 18.19	.906 23.01	Blue	.150 3.81	323817
		10	.375 9.53	.312 7.92	.716 18.19	.906 23.01	Blue	.150 3.81	323818

Note: "C" dimension applies from edge of metal wire barrel to center of stud hole.

PIDG Terminals and Splices (Continued)

Offset Ring Tongue Terminals
(Insulation Restricting)

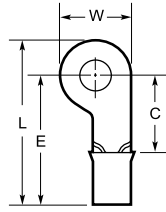

Material
Insulation -Nylon, UL 94V-2
Terminal Body and Metallic Sleeve -Copper per ASTM B-152
Plating -Tin per ASTM B-545

Related Product Data
Insulation Color Code -pg. 4
Packaging Quantities -pg. 4
Performance Specifications - pgs. 4 & 5
Application Tooling -pg. 66

Wire Size Circular Mils [mm ²]	Tongue Material Thickness Max.	Stud Size	Dimensions				Terminal Insulation Color Solid/Stripe	Wire Insulation Diameter Range	Part Numbers	
			W	C Min.	E Max.	L Max.			Loose Piece	
22 754 [0.38]	.033 0.84	6 M3.5	.375 9.53	.312 7.92	.758 19.25	.946 24.03	Red/Green	.038-.110 0.97-2.79	52284-4	
20 1,186 [0.60]	.033 0.84	6 M3.5	.375 9.53	.312 7.92	.758 19.25	.946 24.03	Red/Red	.046-.110 1.17-2.79	52284-2	
		10	.375 9.53	.312 7.92	.758 19.25	.946 24.03	Red/Red	.046-.110 1.17-2.79	52284-3	
16 2,800 [1.42]	.033 0.84	6 M3.5	.375 9.53	.312 7.92	.748 19.00	.938 23.83	Blue/Blue	.063-.130 1.60-3.30	52283-2	
14 4,234 [2.15]	.033 0.84	10	.375 9.53	.312 7.92	.748 19.00	.938 23.83	Blue/Green	.078-.130 1.98-3.30	52283-1	

Note: "C" dimension applies from edge of metal wire barrel to center of stud hole.

PIDG Terminals and Splices (Continued)

SHUR-PLUG Terminal

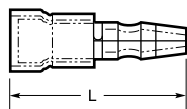

.156 Series

Material

Insulation -Nylon, UL 94V-2

Terminal Body and Metallic Sleeve -Copper per ASTM B-152

Plating -Tin per ASTM B-545

Related Product Data

Insulation Color Code -pg. 4

Packaging Quantities -pg. 4

Performance Specifications - pgs. 4 & 5

Application Tooling -pg. 66

Wire Size Circular Mils [mm ²]	Dimension	Terminal Insulation Color	Wire Insulation Diameter Max.	Part Numbers	
	L Max.			Loose Piece	Tape Mounted
16-14 2,050-5,180 [1.04-2.62]	.790 20.07	Blue	.170 4.32	324225*	2-324225-1
16-14 Receptacle 2,050-5,180 [1.04-2.62]	.768 19.51	Blue	.157 3.99	165429-1	—

*Available in small packaging quantities.

3-Way Connector Terminal

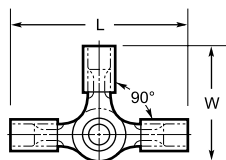

Material

Insulation -Nylon, UL 94V-2

Terminal Body and Metallic Sleeve -Copper per ASTM B-152

Rivet -Brass per QQ-B-626

Plating -Tin per ASTM B-545

Related Product Data

Insulation Color Code -pg. 4

Packaging Quantities -pg. 4

Performance Specifications - pgs. 4 & 5

Application Tooling -pg. 66

Wire Size Circular Mils [mm ²]	Tongue Material Thickness Max.	Dimensions		Terminal Insulation Color	Wire Insulation Diameter Max.	Part Number
		W Max.	L Max.			Loose Piece
16-14 2,050-5,180 [1.04-2.62]	.033 0.84	.859 21.82	1.370 34.80	Blue	.170 4.32	53222-1*

*Available in small packaging quantities.

PIDG Terminals and Splices (Continued)

Tabs

Material

Insulation -Nylon, UL 94V-2

Terminal Body and Metallic Sleeve -Copper per ASTM B-152

Plating -Tin per ASTM B-545

Related Product Data

Insulation Color Code -pg. 4

Packaging Quantities -pg. 4

Performance Specifications - pgs. 4 & 5

Application Tooling -pg. 66

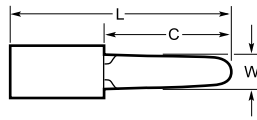

Style A

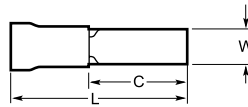

Style B

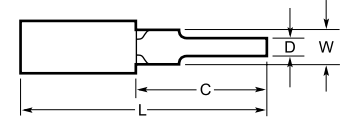

Style C

Wire Size Circular Mils [mm ²]	Tongue Material Thickness Max.	Style	Dimensions				Terminal Insulation Color	Wire Insulation Diameter Max.	Part Numbers Loose Piece
			W	C Min.	L Max.	D			
22-16 509-3,260 [0.26-1.65]	.033 0.84	A	.140 3.56	.480 12.19	.904 22.96	—	Red .140 3.56	34294*	
16-14 2,050-5,180 [1.04-2.62]	.033 0.84	B	.156 3.96	.375 9.53	.809 20.55	—	Blue .170 4.32	327748	
12-10 5,180-13,100 [2.62-6.64]	.042 1.07	C	.225 5.72	.600 15.24	1.194 30.33	.125 3.18	Yellow .230 5.84	324543*	

*Available in small packaging quantities.

Note: "C" dimension applies from edge of metal wire barrel to end of tab.

PIDG Terminals and Splices (Continued)

Butt Splices

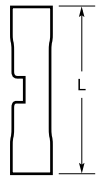

Standard and Radiation Resistant

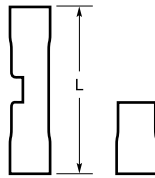

Step Down Assembly¹

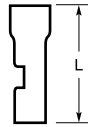

Special

Material

Insulation Sleeve - Standard, Step Down Assembly and Special - Nylon Radiation Resistant - Polyvinylidene Fluoride (PVF₂)

Splice Body and Insulation Support Sleeve - Copper per ASTM B-152

Plating - Tin per ASTM B-545

Related Product Data

Insulation Color Code -pg. 4

Packaging Quantities -pg. 4

Performance Specifications -pgs. 4 & 5

Application Tooling -pg. 66

Wire Size Circular Mils ² [mm ²]	Style	Dimension L Max.	Splice Insulation Color	Wire Insulation Diameter Max.	Part Numbers	
					Loose Piece	Tape Mounted
26-24 ³ 238-475 [0.12-0.24]	Standard	.890 22.61	Yellow	.082 2.08	323994	2-323994-1
26-22 202-810 [0.10-0.41]		.890 22.61	Yellow	.082 2.08	2-323994-2*	—
24-20 320-1,290 [0.16-0.65]		1.035 26.29	Natural	.100 2.54	323975	2-323975-3
22-16 ⁴ 509-3,260 [0.26-1.65]		1.265 32.13	Red	.125 3.18	320559*	2-320559-4
16-14 2,050-5,180 [1.04-2.62]		1.265 32.13	Blue	.150 3.81	320562*	2-320562-3
12-10 5,180-13,100 [2.62-6.64]		1.656 42.06	Yellow	.220 5.59	320570*	2-320570-3 ¹
16-14 2,050-5,180 [1.04-2.62]	22-18 509-1,900 [0.26-0.96]	1.265 32.13	Blue	.150/.115 3.81/2.92	327583	2-327583-1
12-10 5,180-13,100 [2.62-6.64]	22-18 509-1,900 [0.26-0.96]	1.656 42.06	Yellow	.220/.140 5.59/3.56	327639	—
12-10 5,180-13,100 [2.62-6.64]	16-14 2,050-5,180 [1.04-2.62]	1.656 42.06	Yellow	.220/.170 5.59/4.32	327638	—
26-24 ³ 238-475 [0.12-0.24]	Radiation Resistant	.890 22.61	Natural w/ Yellow Stripes	.082 2.08	53546-1	—
26-22 202-810 [0.10-0.41]		.890 22.61	Natural w/ Yellow Stripes	.082 2.08	53546-3	—
24-20 320-1,290 [0.16-0.65]		1.035 26.29	Natural w/ White Stripes	.100 2.54	53547-1	53547-2
22-16 ⁴ 509-3,260 [0.26-1.65]		1.265 32.13	Natural w/ Red Stripes	.125 3.18	53548-1*	53548-2
16-14 2,050-5,180 [1.04-2.62]		1.265 32.13	Natural w/ Blue Stripes	.150 3.81	53549-1*	53549-2
12-10 5,180-13,100 [2.62-6.64]		1.656 42.06	Natural w/ Yellow Stripes	.220 5.59	53550-1*	—
12-10 5,180-13,100 [2.62-6.64]	Special	1.245 31.62	Yellow	.220 5.59	328961 ⁵	—

*Available in small packaging quantities.

¹Includes adapter insert.

²When using two or more wires in either end of a butt splice, the combined cross sectional area must be within the (CMA) circular mil area range listed.

³26-24 range in accordance with MIL-T-7928.

⁴22-16 splices are 22-18 range in accordance with MIL-T-7928.

⁵12-10 butt splice, threaded 8-32 one end.

¹AMP-TAPETRONIC machine tools only.

PIDG Terminals and Splices (Continued)

Butt Splice Step Down Adapter Inserts¹



Material
Adapter Body -Copper per ASTM B-152
Plating -Zinc Plate/ DyeChromate

Related Product Data
Insulation Color Code -pg. 4
Packaging Quantities -pg. 4
Performance Specifications - pgs. 4 & 5
Application Tooling -pg. 66

Butt Splice		Adapter Insert			
Wire Size Circular Mils [mm ²]	Part No.	Wire Size Circular Mils [mm ²]	Dimension L	Color Code	Part Numbers
16-14 2,050-5,180 [1.04-2.62]	320562	22-18 509-1,900 [0.26-0.96]	.350 8.89	Red	1-327635-1
			.402 10.21	Red	327635*
12-10 5,180-13,100 [2.62-6.64]	320570	22-18 509-1,900 [0.26-0.96]	.562 14.27	Red	327636*
		16-14 2,050-5,180 1.04-2.62]	.562 14.27	Blue	327637*

*Available in small packaging quantities.

¹Adapter inserts can be ordered separately for use in specific Standard PIDG Butt Splices.

PIDG Terminals and Splices

Knife Disconnect Splices

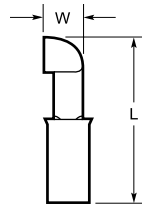

Material
Insulation -Nylon, UL 94V-2
Splice Body and Metallic Sleeve -Copper per ASTM B-152
Plating -Tin per ASTM B-545

Related Product Data
Insulation Color Code -pg. 4
Packaging Quantities -pg. 4
Performance Specifications - pgs. 4 & 5
Application Tooling -pg. 66

Wire Size Circular Mils [mm ²]	Material Thickness	Dimensions		Splice Insulation Color	Wire Insulation Diameter Max.	Part Numbers	
		W	L Max.			Loose Piece	Tape Mounted
22-16 509-3,260 [0.26-1.65]	.031 0.79	.203 5.16	.878 22.30	Red	.125 3.18	320555*	—
		.203 5.16	.878 22.30	Red	.140 3.56	32446*	2-32446-1
16-14 2,050-5,180 [1.04-2.62]	.031 0.79	.203 5.16	.878 22.30	Blue	.150 3.81	320566*	—
		.203 5.16	.878 22.30	Blue	.170 4.32	32448*	—
12-10 5,180-13,100 [2.62-6.64]	.040 1.02	.281 7.14	1.234 31.34	Yellow	.230 5.84	320620*	—
		.281 7.14	1.260 32.00	Yellow	.250 6.35	35762*	—

*Available in small packaging quantities.

PIDG FASTON Terminals and Splices

Product Facts

- Pre-insulated terminal designed for uniformed reliability in most difficult circuit environment
- Consists of an unplated or tin-plated brass body or a tin-plated phosphor bronze body with a specially designed copper sleeve and insulation sleeve fitted over the terminal barrel
- Design of the tool dies and construction of the terminal permits uniform insulation thickness under crimping pressure, transmitting this pressure evenly to the center of the crimp area

The AMP Mated Tool/Terminal Concept

- AMP compression crimping produces crimps for a given size wire and terminal that are alike in appearance and performance
- Terminal and the crimping tool are designed as uniform matched devices
- Dies are precision-engineered from the finest hard-metal alloys
- Crimping pressure is controlled by a ratchet device on the hand tool or a corresponding pre-calibration in the crimping jaws of AMP automated crimping machines

The Crimp

- When done properly, crimping pressure can neither overstress nor under stress the terminal barrel—machined dies fully bottom to the precise crimp height
- Resulting termination is free of contamination
- Resistant to shock and critical environments
- Tensile strength approaches that of the wire itself

Nylon Insulation. Nylon sleeve has high dielectric strength.

Color Coding. Terminal insulation is color-coded by wire range to prevent errors during installation.

Copper Sleeve. The specially designed copper sleeve, fitted over the terminal barrel, provides circumferential insulation support to the wire and allows the wire to be bent in any direction, without fraying the wire's insulation or breaking the conductor.

Funnel Ramp Entry. Prevents a turned back strand and rapid wire insertion during high speed production.

Serrations. Serrations inside barrel provide maximum contact and tensile strength after crimping.

Basic Terminal Material. The basic terminal is constructed of fine grade high conductivity brass per ASTM B-36 or phosphor bronze per ASTM B-139. The brass terminal is either unplated or tin-plated per ASTM B-545. The phosphor bronze terminal is tin-plated per ASTM B-545. Tyco Electronics' special plating process creates durable corrosion resistance to salt spray and most chemical fumes.

Temperature Rating: 105°C Max.

AMP PIDG FASTON Terminals (Use TETRA-CRIMP Tooling)

AMP Wire Range	Component Recognized File E 66717	UL & CSA — Nylon except where noted	LR 7189 Certified
22-18	22-18 Stranded	300 V Max., 105°C. Max. ¹	
16-14	16-14 Stranded		
12-10	12-10 Stranded		

AMP PIDG FASTON Line Splice Connectors "250" Series

Component Recognized File E 66717	105°C Max. (Vinyl)	LR 7189 Certified	105°C Max. (Vinyl)
AMP Part No. 1-321235-0 1-321235-1	600 V Max.	AMP Part No. 1-321235-0 1-321235-1	300 V Max.
321235 321688	300 V Max.	321235 321688	300 V Max.

PIDG FASTON Terminals and Splices

PIDG FASTON Terminals and Splices (Continued)

Receptacles

Receptacle Style:

- A** - No dimple with wire stop
- B** - Dimple with wire stop
- C** - No dimple, no wire stop

Material

- Insulation** -Nylon, UL 94V-2
- Receptacle Body** -Brass per ASTM B-36 or Phosphor Bronze per ASTM B-139
- Plating** -Tin per ASTM B-545 except where noted.
- Metallic Sleeve** -Copper per ASTM B-152
- Plating** -Tin per ASTM B-545

Related Product Data

- Insulation Color Code** -pg. 4
- Packaging Quantities** -pg. 4
- Performance Specifications** -pgs. 4 & 5
- Application Tooling** -pg. 67

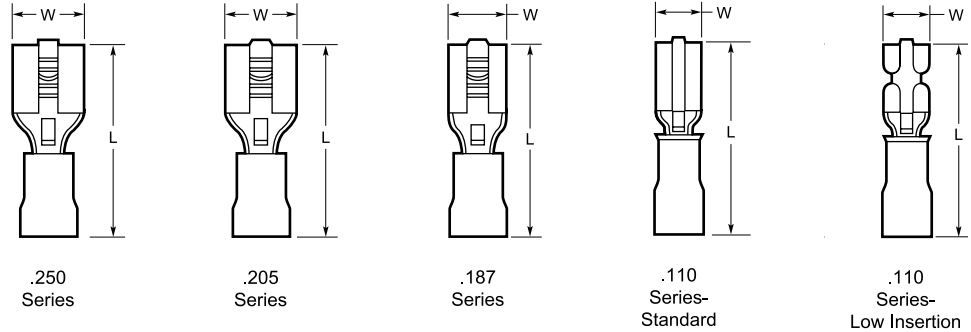

Series	Wire Size Circular Mils [mm ²]	Style	Dimensions		Terminal Insulation Color	Wire Insulation Diameter Max.	Recept. Matl.	Stock Thk.	Fits Tab Thk.	Part Numbers			
			W Nom.	L Max.						Loose Piece	Tape Mounted	Strip Form	
.250	22-18 509-1,900 [0.26-0.96]	B	.300	.900	Red	.140	Brass	.018	.032	640903-1*	640903-2	640902-1	
			7.62	22.86	Red	3.56	Brass	0.46	0.81	55675-1 ²	55675-2 ²	—	
	16-14 2,050-5,180 [1.04-2.62]	B	.300	.900	Blue	.170	Brass	.018	.032	640905-1*	640905-2	640904-1	
			7.62	22.86	Blue	4.32	Brass	0.46	0.81	—	—	—	
	14-12 3,831-6,470 ¹ [1.94-3.28]	B	.300	1.012	Green	.250	Brass	.018	.032	42844-1**	42844-3*	60544-3*	
			7.62	25.70	Green	6.35	Phos. Brz.	0.46	0.81	42844-2**	—	—	
		12-10 5,180-13,100 [2.62-6.64]	B	.300	1.012	Yellow	.250	Brass	.018	.032	640907-1*	640907-2	640906-1
				7.62	25.70	Yellow	6.35	Phos. Brz.	0.46	0.81	61198-2	61198-4	—
.250 Low Insertion	22-18 509-1,900 [0.26-0.96]	B	.300	.900	Red	.145	Brass	.016	.032	184262-1	184262-2	184261-1	
			7.62	22.86	Red	3.68	Brass	.406	.813	—	—	—	
16-14 2,050-5,180 [1.04-2.62]	B	.300	.900	Blue	.173	Brass	.016	.032	184265-1	184265-2	184264-1		
		7.62	22.86	Blue	4.39	Brass	.406	.813	—	—	—		
.205	22-18 509-1,900 [0.26-0.96]	B	.250	.800	Red	.135	Brass	.016	.020	696018-1	696018-2	—	
			6.35	20.32	Red	3.43	Brass	0.41	0.51	—	—	—	
			.250	.800	Red/Black	.140	Brass	.016	.020	640909-1*	640909-2	640908-1	
	16-14 2,050-5,180 [1.04-2.62]	B	.250	.800	Red	.140	Brass	.016	.032	640174-1	—	—	
			6.35	20.32	Red	3.56	Brass	0.41	0.81	640911-1*	640911-2	640910-1	
			.250	.800	Blue	.170	Brass	.016	.020	640913-1*	640913-2	—	
26-24 238-475 [0.12-0.24]	B	.230	.700	Yellow	.082	Brass	.016	.020	641321-1**	641321-2*	641320-1*		
		5.84	17.78	Yellow	2.08	Brass	0.41	0.51	—	—	—		
.187	22-18 509-1,900 [0.26-0.96]	B	.230	.800	Red	.140	Brass	.016	.020	640917-1*	640917-2	640916-1	
			5.84	20.32	Red	3.56	Brass	0.41	0.51	—	—	—	
.187	22-18 509-1,900 [0.26-0.96]	B	.230	.800	Red	.140	Brass	.016	.040	—	640578-2*	—	
			5.84	20.32	Red	3.56	Brass	0.41	1.02	—	—	—	

¹Not UL or CSA approved or listed.

*Available in small packaging quantities.

¹Wire range is limited as noted.

²Unplated receptacle body.

PIDG FASTON Terminals and Splices (Continued)

Receptacles

(Continued)

Series	Wire Size Circular Mils [mm ²]	Style	Dimensions		Terminal Insulation Color	Wire Insulation Diameter Max.	Recept. Matl.	Stock Thk.	Fits Tab Thk.	Part Numbers		
			W Nom.	L Max.						Loose Piece	Tape Mounted	Strip Form
.187	16-14 2,050-5,180 [1.04-2.62]	B	.230 5.84	.800 20.32	Blue	.170 4.32	Brass	.016 0.41	.020 0.51	640919-1*	640919-2	640918-1
			.230 5.84	.900 22.86	Blue	.250 6.35	Brass	.016 0.41	.020 0.51	696108-1	696108-2	—
.187 Low Insertion	22-18 509-1,900 [0.26-0.96] 16-14 2,050-5,180 [1.04-2.62]		.230 5.84	.800 22.86	Red	.145 3.68	Brass	.016 .406	.032 .813	184268-1	184268-2	184267-1
			.300 7.62	.900 22.86	Blue	.173 4.39	Brass	.016 .406	.032 .813	184235-1	184235-2	184234-1
.110 Standard	22-18 509-1,900 [0.26-0.96]	B	.148 3.76	.734 18.64	Natural	.110 2.79	Brass	.012 0.30	.016 0.41	61048-1**	61048-2 [†]	—
			.148 3.76	.734 18.64	Natural	.110 2.79	Brass	.012 0.30	.020 0.51	61060-1**	61060-2 [†]	61059-2 [†]
			.148 3.76	.734 18.64	Natural	.110 2.79	Brass	.012 0.30	.032 0.81	60894-1**	60894-2 [†]	60893-2 [†]
			.148 3.76	.734 18.64	Black	.110 2.79	Brass	.012 0.30	.032 0.81	—	61678-2 [†]	—
.110 Low Insertion	26-24 238-475 [0.12-0.24]	A	.160 4.06	.700 17.78	Yellow	.082 2.08	Brass	.016 0.41	.020 0.51	641324-1 [†]	641324-2 [†]	—
			.160 4.06	.796 20.22	Red	.140 3.56	Brass	.016 0.41	.012 0.30	—	—	350871-1 [†]
	22-18 509-1,900 [0.26-0.96]	A	.160 4.06	.800 20.32	Red	.140 3.56	Brass	.016 0.41	.016 0.41	640921-1	640921-2	—
			.160 4.06	.800 20.32	Red	.140 3.56	Brass	.016 0.41	.020 0.51	640923-1*	640923-2	640922-1
			.160 4.06	.800 20.32	Red	.140 3.56	Brass	.016 0.41	.032 0.81	640925-1*	640925-2	640924-1
	16-14 2,050-5,180 [1.04-2.62]	A	.160 4.06	.800 20.32	Blue	.170 4.32	Brass	.016 0.41	.020 0.51	640929-1*	640929-2	—
			.160 4.06	.800 20.32	Blue	.170 4.32	Brass	.016 0.41	.032 0.81	640931-1*	640931-2	—
.160 4.06			.800 20.32	Blue	.170 4.32	Brass	.016 0.41	.016 0.41	640927-1	640927-2	—	
		C	.160 4.06	.796 20.19	Blue	.170 4.32	Brass	.016 0.41	.032 0.81	641317-1	—	—

*Not UL or CSA approved or listed.

*Available in small packaging quantities.

Receptacles

(Insulation Restricting)

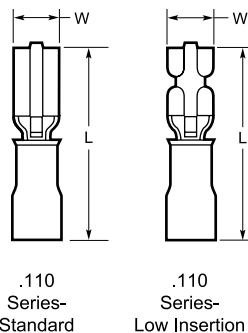

Material

Insulation -Nylon, UL 94V-2

Receptacle Body -Brass per ASTM B-36

Receptacle Style B-Dimple with wire stop

Plating -Tin per ASTM B-545

Metallic Sleeve -Copper per ASTM B-152

Plating -Tin per ASTM B-545 or Nickel per QQ-N-290

Related Product Data

Insulation Color Code -pg. 4

Packaging Quantities -pg. 4

Performance Specifications - pgs. 4 & 5

Application Tooling -pg. 67

Series	Wire Size Circular Mils [mm ²]	Style	Dimensions		Terminal Insulation Color Solid / Stripe	Wire Insulation Diameter Range	Recept. Matl.	Stock Thk.	Fits Tab Thk.	Part Numbers		
			W Nom.	L Max.						Loose Piece	Tape Mounted	Strip Form
.110 Standard	22 754 [0.38]	B	.148 3.76	.780 19.81	Red/ Green	.040-.080 1.02-2.03	Brass	.012 0.30	.016 0.41	55319-1	55319-3	—

PIDG FASTON Terminals and Splices (Continued)

Line Splice Connector for "250" Series Terminals

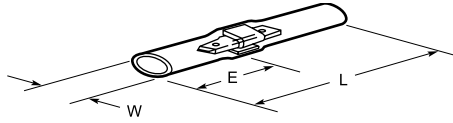

Material
Insulation -Vinyl, UL 94V-0
Color -Natural
Splice Body -Brass per ASTM B-36
Plating -Tin per ASTM B-545 except where noted.

Related Product Data
Insulation Color Code -pg. 4
Packaging Quantities -pg. 4
Performance Specifications - pgs. 4 & 5

Wire Size	Plating	Dimensions			Part Numbers Loose Piece
		W	L Max.	E Min.	
22-10	Unplated	.391 9.93	2.093 53.16	.860 21.84	321235*
	Tin	.391 9.93	2.093 53.16	.860 21.84	321688
	Unplated	.409 10.39	2.625 66.68	1.151 29.24	1-321235-0
	Tin	.409 10.39	2.625 66.68	1.151 29.24	1-321235-1
	Unplated	.409 10.39	2.451 62.26	.970 ² 24.64	1-321235-3 ¹

*Available in small packaging quantities.

¹Oval expansion at end opposite "w". (.380 x .320 inside diameter.)

²E min. on expansion end only.

Line Splice Connector for "187" Series Terminals

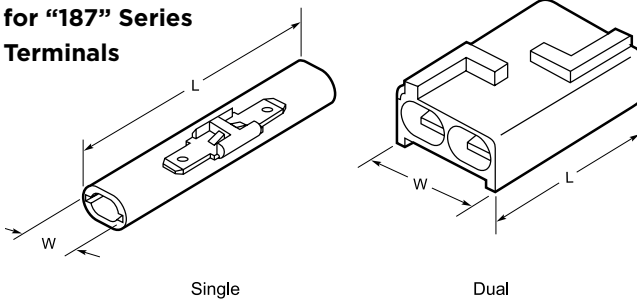

Material
Housing -Nylon, UL 94V-2
Splice Body -Brass per ASTM B-36

Related Product Data
Insulation Color Code -pg. 4
Packaging Quantities -pg. 4
Performance Specifications - pgs. 4 & 5

Type	Housing Color	Dimensions		Temperature Rating	Part Numbers Loose Piece
		W	L		
Single	Natural	.345 8.76	1.750 44.45	—	360035-1 ¹
Dual	Natural	.650 16.51	1.750 44.45	105°C	360025-1 ¹
Dual	Black	.650 16.51	1.750 44.45	150°C	360025-2 ¹

¹UL File E66717
600 V Max

Receptacle (Low Insertion Force)

Series	Wire Size Circular Mils [mm ²]	Dimensions		Terminal Insulation Color	Wire Insulation Diameter Max.	Recept. Matl.	Stock Thk.	Fits Tab Thk.	Part Numbers		
		W Nom.	L Max.						Loose Piece	Tape Mounted	Strip Form
.250 Low Insertion	22-18 509-1,900 [0.26-0.96]	.300 7.62	.900 22.86	Red	.145 3.68	Brass	.016 .406	.032 .813	184262-1	184262-2	184261-1
.250 Low Insertion	16-14 2,050-5,180 [1.04-2.62]	.300 7.62	.900 22.86	Blue	.173 4.39	Brass	.016 .406	.032 .813	184265-1	184265-2	184264-1
.187 Low Insertion	22-18 509-1,900 [0.26-0.96]	.230 5.84	.800 22.86	Red	.145 3.68	Brass	.016 .406	.032 .813	184268-1	184268-2	184267-1
.187 Low Insertion	16-14 2,050-5,180 [1.04-2.62]	.300 7.62	.900 22.86	Blue	.173 4.39	Brass	.016 .406	.032 .813	184235-1	184235-2	184234-1

PLASTI-GRIP Terminals and Splices

Product Facts

- Pre-insulated PLASTI-GRIP solderless terminals and splices
- Designed specifically to answer the need for inexpensive, insulated electrical terminations
- Can be used in almost every type of commercial application
- Accommodate wire sizes from 22 AWG through 2/0 AWG

The Crimp

- Carefully engineered application tooling has been developed to ensure uniformly high quality terminations
- Tool and terminal have been designed as a team to promote ease and speed of application and at the same time to provide precise crimping pressure for every wire size
- The wire and the terminal barrel form a homogeneous mass of metal, providing a connection of maximum conductivity, tensile strength, and high resistance to corrosion
- The quality performance, the facility of installation and the inherent simplicity make them well-suited for many industrial applications

Basic Terminal Material. The basic terminal is constructed of fine grade high conductivity copper per ASTM B-152 and tin-plated per ASTM B-545. Basic material for Spring Spade Tongue Terminals is phosphor bronze per ASTM B-139 or brass per ASTM B-36 and tin-plated per ASTM B-545. Tyco Electronics' special plating process creates durable corrosion resistance to salt spray and most chemical fumes.

Color Coding. Terminal insulation is color-coded by wire size range to eliminate errors during installation.

Insulation. Vinyl insulation sleeve provides good dielectric strength and supports the wire insulation so that no bare wire is exposed.

Serrations. Serrations inside barrel provide maximum contact and tensile strength after crimping. Dimples on 8 to 2/0 range.

Funnel Entry. Assures rapid wire insertion during high speed production. (Except 8 to 2/0 range.)

Temperature Rating: 90°C Max.

AMP PLASTI-GRIP Terminals and Splices (Use PLASTI-GRIP or PIDG Tooling)

AMP Wire Range	UL Listed	SP® LR 7189 Certified	UL 8 thru 4/0 600V
Except as noted with individual part number listing.			
22-16	Terminals, Butt & Parallel Splices 22-16 Solid or Stranded ¹	600 V Max. (1000 V Fixture or Sign) 90°C Max.	Recognized under the component program of Underwriters Laboratories Incorporated File No. E13288
16-14	Terminals, Butt & Parallel Splices 16-14 Solid or Stranded ¹		
12-10	Terminals, Butt & Parallel Splices 12-10 Solid or Stranded ¹		

Note: 22-16 terminals and splices are stamped 22-18 in accordance with MIL-T-7928.

¹Stranded wire only using TETRA-CRIMP tooling.

PLASTI-GRIP Terminals and Splices (Continued)

Ring Tongue Terminals

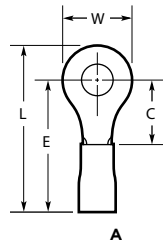

Material
Insulation -Vinyl, UL 94V-0
Terminal Body -Copper per ASTM B-152
Plating -Tin per ASTM B-545

Related Product Data
Insulation Color Code -pg. 4
Packaging Quantities -pg. 4
Performance Specifications -pgs. 4 & 5
Application Tooling -pg. 66

Wire Size Circular Mils [mm ²]	Tongue Material Thickness Max.	Stud Size	Style	Dimensions				Terminal Insulation Color	Wire Insulation Diameter Max.	Part Numbers	
				W	C Min.	E Max.	L Max.			Loose Piece	Tape Mounted
22-16 509-3,260 [0.26-1.65]	.033 0.84	2 M2	A	.218 5.54	.156 3.96	.572 14.53	.684 17.37	Red	.140 3.56	34140*	2-34140-1
				.218 5.54	.156 3.96	.572 14.53	.684 17.37	Red	.125 3.18	32944*	2-32944-1
		4	A	.218 5.54	.156 3.96	.572 14.53	.684 17.37	Red	.140 3.56	34141*	2-34141-1
				.281 7.14	.250 6.35	.666 16.92	.809 20.55	Red	.140 3.56	34143	2-34143-1
				.218 5.54	.156 3.96	.572 14.53	.684 17.37	Red	.125 3.18	32945*	2-32945-1
				.218 5.54	.156 3.96	.572 14.53	.684 17.37	Red	.140 3.56	34142*	1-34142-1
				.281 7.14	.250 6.35	.666 16.92	.809 20.55	Red	.125 3.18	32947*	2-32947-1
				.281 7.14	.250 6.35	.666 16.92	.809 20.55	Red	.140 3.56	34144*	2-34144-1
		6 M3.5	A	.281 7.14	.250 6.35	.666 16.92	.809 20.55	Black	.140 3.56	326819	2-326819-1
				.281 7.14	.250 6.35	.666 16.92	.809 20.55	Red	.170 4.32	—	2-35449-1
				.312 7.92	.281 7.14	.697 17.70	.856 21.74	Red	.125 3.18	32950	2-32950-1
				.312 7.92	.281 7.14	.697 17.70	.856 21.74	Red	.140 3.56	34147*	2-34147-1
				.281 7.14	.250 6.35	.666 16.92	.809 20.55	Red	.125 3.18	32948*	2-32948-1
				.281 7.14	.250 6.35	.666 16.92	.809 20.55	Red	.140 3.56	34145*	2-34145-1
		8 M4	A	.312 7.92	.281 7.14	.697 17.70	.856 21.74	Red	.125 3.18	32951*	2-32951-1
				.312 7.92	.281 7.14	.697 17.70	.856 21.74	Red	.140 3.56	34148*	2-34148-1
				.312 7.92	.281 7.14	.746 18.95	.905 22.99	Red	.200 5.08	—	2-34148-4
				.281 7.14	.250 6.35	.666 16.92	.809 20.55	Red	.125 3.18	32949*	2-32949-1
				.281 7.14	.250 6.35	.666 16.92	.809 20.55	Red	.140 3.56	34146*	2-34146-1
				.281 7.14	.250 6.35	.666 16.92	.809 20.55	Black	.140 3.56	2-34146-4	2-34146-5
		10	A	.281 7.14	.250 6.35	.666 16.92	.809 20.55	Red	.170 4.32	35451	2-35451-1
				.312 7.92	.281 7.14	.697 17.70	.856 21.74	Red	.125 3.18	32952*	2-32952-1
				.312 7.92	.281 7.14	.697 17.70	.856 21.74	Red	.140 3.56	34149*	2-34149-1
				.312 7.92	.281 7.14	.746 18.95	.905 22.99	Red	.200 5.08	—	2-34149-3
.469 11.91	.437 11.10			.853 21.67	1.090 27.69	Red	.125 3.18	32953*	2-32953-1		
.469 11.91	.437 11.10			.853 21.67	1.090 27.69	Red	.140 3.56	34150*	2-34150-1		
1/4 M6	A	.469 11.91	.437 11.10	.853 21.67	1.090 27.69	Black	.140 3.56	—	2-34150-3		

*Available in small packaging quantities.

PLASTI-GRIP Terminals and Splices (Continued)

Ring Tongue Terminals

(Continued)

Wire Size Circular Mils [mm ²]	Tongue Material Thickness Max.	Stud Size	Style	Dimensions				Terminal Insulation Color	Wire Insulation Diameter Max.	Part Numbers	
				W	C Min.	E Max.	L Max.			Loose Piece	Tape Mounted
22-16 509-3,260 [0.26-1.65]	.033 0.84	5/16 M8	A	.469 11.91	.437 11.10	.853 21.67	1.090 27.69	Red	.140 3.56	34151*	2-34151-1
				.469 11.91	.437 11.10	.853 21.67	1.090 27.69	Black	.140 3.56	—	2-34151-3
		3/8	A	.531 13.49	.546 13.87	.962 24.43	1.230 31.24	Red	.140 3.56	34152*	2-34152-2
				.531 13.49	.546 13.87	.962 24.43	1.230 31.24	Black	.140 3.56	—	2-34152-4
		4	A	.250 6.35	.171 4.34	.587 14.91	.715 18.16	Blue	.170 4.32	34157*	2-34157-1
				.250 6.35	.171 4.34	.587 14.91	.715 18.16	Blue	.145 3.68	32957*	2-32957-1
		6 M3.5	A	.250 6.35	.171 4.34	.587 14.91	.715 18.16	Blue	.170 4.32	34158*	2-34158-1
				.343 8.71	.281 7.14	.697 17.70	.871 22.12	Blue	.145 3.68	32958*	2-32958-1
				.343 8.71	.281 7.14	.697 17.70	.871 22.12	Blue	.170 4.32	34159*	2-34159-1
				.312 7.92	.250 6.35	.666 16.92	.825 20.96	Blue	.170 4.32	328527*	2-328527-1
		8 M4	A	.343 8.71	.281 7.14	.697 17.70	.871 22.12	Blue	.145 3.68	32959*	2-32959-1
				.343 8.71	.281 7.14	.697 17.70	.871 22.12	Blue	.170 4.32	34160*	2-34160-1
.343 8.71	.281 7.14			.746 18.95	.920 23.37	Blue	.250 6.35	2-34160-2	2-34160-3		
.343 8.71	.281 7.14			.697 17.70	.871 22.12	Blue	.145 3.68	32960*	2-32960-1		
10	A	.343 8.71	.281 7.14	.697 17.70	.871 22.12	Blue	.170 4.32	34161*	2-34161-1		
		.343 8.71	.281 7.14	.746 18.95	.920 23.37	Blue	.250 6.35	2-34161-2	2-34161-3		
		.343 8.71	.281 7.14	.746 18.95	.920 23.37	Black	.250 6.35	—	2-34959-1		
		.468 11.89	.312 7.92	.728 18.49	.965 24.51	Blue	.170 4.32	—	2-34954-1		
		.469 11.91	.437 11.10	.853 21.67	1.090 27.69	Blue	.145 3.68	32961*	2-32961-1		
		.469 11.91	.437 11.10	.853 21.67	1.090 27.69	Blue	.170 4.32	34162*	2-34162-1		
5/16 M8	A	.469 11.91	.437 11.10	.853 21.67	1.090 27.69	Blue	.170 4.32	34163*	2-34163-1		
		.469 11.91	.437 11.10	.853 21.67	1.090 27.69	Black	.170 4.32	2-34162-2	2-34162-3		
3/8	A	.531 13.49	.546 13.87	.962 24.43	1.248 31.70	Blue	.170 4.32	34164*	2-34164-2		
		.531 13.49	.546 13.87	.962 24.43	1.248 31.70	Black	.170 4.32	—	2-34164-4		
16-14HD ¹ 2,050-5,180 [1.04-2.62]	.050 1.27	6 M3.5	A	.281 7.14	.219 5.56	.810 20.57	.953 24.21	Yellow/Blk.	.200 5.08	34821	2-34821-1
		8 M4	A	.343 8.71	.281 7.14	.872 22.15	1.046 26.57	Yellow/Blk.	.200 5.08	34822 [†]	—
		10	A	.343 8.71	.281 7.14	.872 22.15	1.046 26.57	Yellow/Blk.	.200 5.08	34823* [†]	2-34823-1 [†]
				.343 8.71	.281 7.14	.872 22.15	1.046 26.57	Yellow/Blk.	.250 6.35	321518	2-321518-1

[†] Not UL or CSA Approved or Listed.

*Available in small packaging quantities.

¹Heavy Duty for extra mechanical strength.

Note: "C" dimension applies from edge of metal wire barrel to center of stud hole. (Styles A & E).

PLASTIC-GRIP Terminals and Splices

PLASTI-GRIP Terminals and Splices (Continued)

Ring Tongue Terminals

(Continued)

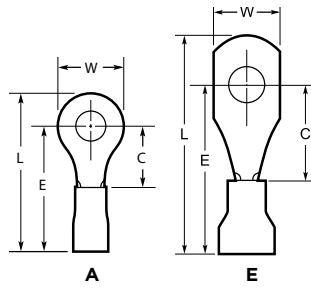

Material

Insulation -Vinyl, UL 94V-0

Terminal Body -Copper per ASTM B-152

Plating -Tin per ASTM B-545

Related Product Data

Insulation Color Code -pg. 4

Packaging Quantities -pg. 4

Performance Specifications -pgs. 4 & 5

Application Tooling -pgs. 66 & 67

Wire Size Circular Mills [mm ²]	Tongue Material Thickness Max.	Stud Size	Style	Dimensions				Terminal Insulation Color	Wire Insulation Diameter Max.	Part Numbers	
				W	C Min.	E Max.	L Max.			Loose Piece	Tape Mounted
16-14HD ¹ 2,050-5,180 [1.04-2.62]	.050 1.27	1/4 M6	A	.500	.344	.935	1.188	Yellow/Blk.	.230	35349	2-35349-1
				12.70	8.74	23.75	30.18	Yellow/Blk.	5.84	—	—
			.531	.437	1.028	1.296	Yellow/Blk.	.200	34824	2-34824-3	
			13.49	11.10	26.11	32.92	Yellow/Blk.	5.08	—	—	
		5/16 M8	A	.531	.437	1.028	1.296	Yellow/Blk.	.200	34825	—
		13.49	11.10	26.11	32.92	Yellow/Blk.	5.08	—	—		
		3/8	A	.750	.625	1.216	1.594	Yellow/Blk.	.200	34826	—
		19.05	15.88	30.89	40.49	Yellow/Blk.	5.08	—	—		
		1/2 M12	A	.750	.625	1.216	1.594	Yellow/Blk.	.200	34827	—
		19.05	15.88	30.89	40.49	Yellow/Blk.	5.08	—	—		
12-10 5,180-13,100 [2.62-6.64]	.042 1.07	0	A	.281	.219	.810	.953	Yellow	.250	2-34835-4	—
			7.14	5.56	20.57	24.21	Yellow	6.35	—	—	
		4	A	.281	.219	.810	.953	Yellow	.250	34835	2-34835-1
			7.14	5.56	20.57	24.21	Yellow	6.35	—	—	
		6 M3.5	A	.281	.219	.810	.953	Yellow	.250	34852*	2-34852-1
				7.14	5.56	20.57	24.21	Yellow	6.35	—	—
			.375	.302	.893	1.098	Yellow	.230	34168*	2-34168-1	
			9.53	7.67	22.68	27.89	Yellow	5.84	—	—	
		8 M4	A	.312	.302	.893	1.062	Yellow	.250	—	696047-1
				7.92	7.67	22.68	26.97	Yellow	6.35	—	696048-1
			.375	.302	.893	1.098	Yellow	.230	34169*	2-34169-1	
			9.53	7.67	22.68	27.89	Yellow	5.84	—	—	
		.375	.302	.893	1.098	Yellow	.250	34853*	2-34853-1		
		9.53	7.67	22.68	27.89	Yellow	6.35	—	—		
		10	A	.312	.302	.893	1.052	Yellow	.230	330518	—
				7.92	7.67	22.68	26.72	Yellow	5.84	—	—
.312	.302		.953	1.111	Yellow	.300	—	1-330518-2			
7.92	7.67		24.21	28.22	Yellow	7.62 ²⁻¹⁰	—	—			
.375	.302		.893	1.083	Black	.250	—	2-328261-1			
9.53	7.67		22.68	27.51	Black	6.35	—	—			
1/4 M6	A	.375	.302	.893	1.098	Yellow	.230	34170*	2-34170-1		
		9.53	7.67	22.68	27.89	Yellow	5.84	—	—		
5/16 M8	A	.375	.302	.893	1.098	Yellow	.250	34854*	2-34854-1		
		9.53	7.67	22.68	27.89	Yellow	6.35	—	—		
3/8	A	.400	.468	1.118	1.373	Yellow	.300	55678-1	55678-2		
		10.16	11.89	28.40	34.87	Yellow	7.62	—	—		
1/4 M6	A	.500	.344	.994	1.247	Black	.300	35492	—		
		12.70	8.74	25.25	31.67	Black	7.62	—	—		
		.531	.468	1.059	1.327	Yellow	.230	34171*	2-34171-1		
		13.49	11.89	26.90	33.71	Yellow	5.84	—	—		
5/16 M8	A	.531	.468	1.059	1.327	Yellow	.250	34855*	2-34855-1		
		13.49	11.89	26.90	33.71	Yellow	6.35	—	—		
3/8	A	.531	.468	1.059	1.327	Yellow	.230	34172*	2-34172-1		
		13.49	11.89	26.90	33.71	Yellow	5.84	—	—		
1/2 M12	A	.531	.468	1.059	1.327	Black	.230	—	2-34172-3		
		13.49	11.89	26.90	33.71	Black	5.84	—	—		
3/8	A	.593	.531	1.122	1.421	Yellow	.230	34856*	2-34856-1		
		15.06	13.49	28.50	36.09	Yellow	5.84	—	—		
1/2 M12	A	.750	.625	1.216	1.594	Yellow	.250	34173*	2-34173-1		
		19.05	15.88	30.89	40.49	Yellow	6.35	—	—		

*Available in small packaging quantities.

¹Heavy Duty for extra mechanical strength.

Note: "C" dimension applies from edge of metal wire barrel to center of stud hole. (Styles A & E).

PLASTI-GRIP Terminals and Splices (Continued)

Ring Tongue Terminals
(Continued)

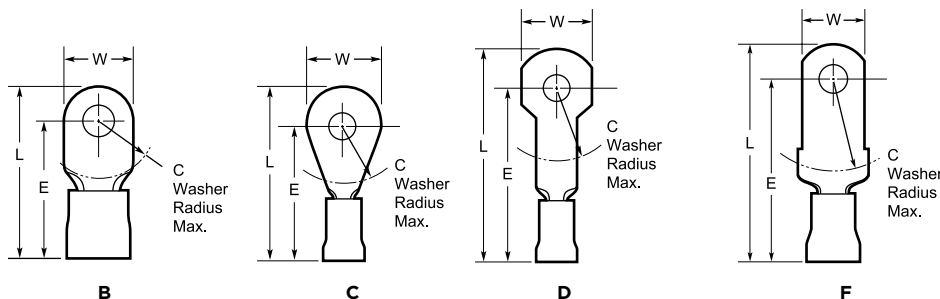

Wire Size Circular Mills [mm ²]	Tongue Material Thickness Max.	Stud Size	Style	Dimensions				Terminal Insulation Color	Wire Insulation Diameter Max.	Part Numbers	
				W	C	E Max.	L Max.			Loose Piece	Tape Mounted
8 13,100-20,800 [6.64-10.5]	.043 1.09	8 M4	C	.478 12.14	.437 11.10	1.344 34.14	1.586 40.28	Red	.360 9.14	52041	52041-6
			D	.430 10.92	.437 11.10	1.363 34.62	1.605 40.77	Red	.360 9.14	—	54351-2
		10	B	.431 10.95	.437 11.10	1.338 33.99	1.556 39.52	Red	.360 9.14	52263	52263-2
			C	.431 10.95	.437 11.10	1.338 33.99	1.556 39.52	Red	.390 9.91	52263-5	52263-4
		1/4 M6	C	.431 10.95	.437 11.10	1.358 34.49	1.576 40.03	Red	.330 8.38	52263-1	52263-3
			C	.478 12.14	.437 11.10	1.303 33.10	1.561 39.65	Red	.360 9.14	55621-1	55621-2
		5/16 M8	C	.478 12.14	.437 11.10	1.344 34.14	1.586 40.28	Red	.360 9.14	52041-1	52041-7
			C	.478 12.14	.437 11.10	1.358 34.49	1.600 40.64	Red	.330 8.38	52041-3*	52041-9
		3/8	C	.587 14.91	.500 12.70	1.400 35.56	1.696 43.08	Red	.360 9.14	52291*	52291-4
			C	.587 14.91	.500 12.70	1.400 35.56	1.696 43.08	Red	.360 9.14	52291-1*	52291-5
		1/2 M12	A	.875 22.23	.625 15.88	1.420 36.07	1.860 47.24	Red	.330 8.38	52262-1	—
			C	.500 12.70	.515 13.08	1.591 40.41	1.844 46.84	Blue	.436 11.07	52042	—
6 20,800-33,100 [10.5-16.8]	.048 1.22	8 M4	C	.500 12.70	.515 13.08	1.591 40.41	1.869 47.47	Blue	.360 9.14	52042-2	—
			C	.500 12.70	.515 13.08	1.591 40.41	1.869 47.47	Blue	.360 9.14	52042-5*	—
		10	B	.468 11.89	.421 10.69	1.482 37.64	1.719 43.66	Blue	.360 9.14	—	52265-4
			C	.468 11.89	.421 10.69	1.482 37.64	1.719 43.66	Blue	.436 11.07	52265*	52265-3
		1/4 M6	F	.500 12.70	.515 13.08	1.591 40.41	1.844 46.84	Blue	.436 11.07	52042-4	—
			C	.398 10.11	.515 13.08	1.591 40.41	1.846 46.89	Blue	.450 11.43	55679-1	55679-2
		5/16 M8	C	.500 12.70	.515 13.08	1.591 40.41	1.844 46.84	Blue	.436 11.07	52042-1	52042-7
			C	.500 12.70	.515 13.08	1.591 40.41	1.869 47.47	Blue	.360 9.14	52042-3*	52042-9
		3/8	B	.625 15.88	.515 13.08	1.591 40.41	1.906 48.41	Blue	.450 11.43	52264*	52264-4
			B	.625 15.88	.515 13.08	1.591 40.41	1.906 48.41	Blue	.450 11.43	52264-1*	52264-5
		1/2 M12	C	.815 20.70	.515 13.08	1.441 36.60	1.851 47.02	Blue	.436 11.07	52350*	—

*Available in small packaging quantities.

Note: "C" dimension applies from edge of metal wire barrel to center of stud hole. (Styles A & E).

PLASTI-GRIP Terminals and Splices (Continued)

Ring Tongue Terminals
(Continued)

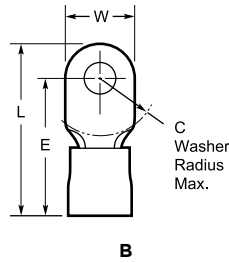

Material
Insulation -Vinyl, UL 94V-0
Terminal Body -Copper per ASTM B-152
Plating -Tin per ASTM B-545

Related Product Data
Insulation Color Code -pg. 4
Packaging Quantities -pg. 4
Performance Specifications -pgs. 4 & 5
Application Tooling -pg. 67

Wire Size Circular Mills [mm ²]	Tongue Material Thickness Max.	Stud Size	Style	Dimensions				Terminal Insulation Color	Wire Insulation Diameter Max.	Part Numbers			
				W	C	E Max.	L Max.			Loose Piece	Tape Mounted		
4 33,100-52,600 [16.8-26.7]	.051 1.30	10	B	.546	.531	1.672	1.948	Yellow	.450	52043-2	—		
				13.87	13.49	42.47	49.48	Yellow	11.43	—	—		
			.546	.531	1.672	1.948	Yellow	.515	52043	52043-4			
			13.87	13.49	42.47	49.48	Yellow	13.08	—	—			
		1/4 M6	B	.391	.531	1.672	1.927	Yellow	.450	—	55680-2		
				9.93	13.49	42.47	48.95	Yellow	11.43	—	—		
			.546	.531	1.672	1.948	Yellow	.450	52043-3*	52043-7			
			13.87	13.49	42.47	49.48	Yellow	11.43	—	—			
		5/16 M8	B	.679	.531	1.672	2.014	Yellow	.450	52266-3	52266-9		
				17.25	13.49	42.47	51.16	Yellow	11.43	—	—		
		3/8	B	.679	.531	1.672	2.014	Yellow	.515	52266-4*	1-52266-0		
				17.25	13.49	42.47	51.16	Yellow	13.08	—	—		
2 52,600-83,700 [26.7-42.4]	.060 1.52	1/4 M6	B	.675	.578	1.731	2.071	Red	.560	52267-1	—		
				17.15	14.68	43.97	52.60	Red	14.22	—	—		
			.675	.578	1.731	2.071	Red	.632	52267	—			
			17.15	14.68	43.97	52.60	Red	16.05	—	—			
		5/16 M8	B	.711	.578	1.731	2.089	Red	.560	52044-4	—		
				18.06	14.68	43.97	53.06	Red	14.22	—	—		
		3/8	B	.711	.578	1.731	2.089	Red	.632	52044-1	—		
				18.06	14.68	43.97	53.06	Red	16.05	—	—		
		1/0 83,700-119,500 [42.4-60.6]	.073 1.85	5/16 M8	B	.807	.625	2.041	2.447	Blue	.560	52044-5	—
						20.50	15.88	51.84	62.15	Blue	14.22	—	—
				3/8	B	.807	.625	2.041	2.447	Blue	.684	52044-2	—
						20.50	15.88	51.84	62.15	Blue	16.05	—	—
1/2 M12	B	.875	.625	2.041	2.478	Blue	.684	52045-1	—				
		22.23	15.88	51.84	62.94	Blue	17.37	—	—				
2/0 119,500-150,500 [60.6-76.3]	.083 2.11	5/16 M8	B	.926	.625	2.082	2.477	Yellow	.665	52045-5	—		
				23.52	15.88	52.88	62.92	Yellow	16.89	—	—		
				.807	.625	2.041	2.447	Blue	.684	52045-2	—		
				20.50	15.88	51.84	62.15	Blue	17.37	—	—		

*Available in small packaging quantities.

PLASTI-GRIP Terminals and Splices (Continued)

**Ring Tongue
90° Bend Terminals**

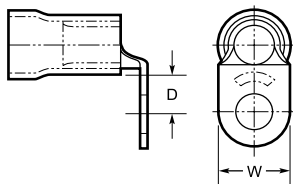

Material
Insulation -Vinyl, UL 94V-0
Terminal Body -Copper per ASTM B-152
Plating -Tin per ASTM B-545

Related Product Data
Insulation Color Code -pg. 4
Packaging Quantities -pg. 4
Performance Specifications - pgs. 4 & 5
Application Tooling -pg. 67

Wire Size Circular Mils [mm ²]	Tongue Material Thickness Max.	Stud Size	Dimensions		Terminal Insulation Color	Wire Insulation Diameter Max.	Part Numbers	
			W	D Min.			Loose Piece	
8 13,100-20,800 [6.64-10.5]	.043 1.09	10	.431 10.95	.311 7.90	Red	.360 9.14	55654-1	
		1/4 M6	.478 12.14	.435 11.05	Red		54725-1	
6 20,800-33,100 [10.5-16.8]	.048 1.22	10	.500 12.70	.310 7.87	Blue	.436 11.07	54753-1	
		1/4 M6	.500 12.70	.379 9.63	Blue		54754-1	

**Rectangular
Tongue Terminals**

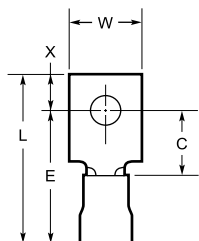

Material
Insulation -Vinyl, UL 94V-0
Terminal Body -Copper per ASTM B-152
Plating -Tin per ASTM B-545

Related Product Data
Insulation Color Code -pg. 4
Packaging Quantities -pg. 4
Performance Specifications -pgs. 4 & 5
Application Tooling -pg. 66

Wire Size Circular Mils [mm ²]	Tongue Material Thickness Max.	Stud Size	Dimensions					Terminal Insulation Color	Wire Insulation Diameter Max.	Part Numbers	
			W	C Min.	E Max.	L Max.	X			Loose Piece	Tape Mounted
16-14 2,050-5,180 [1.04-2.62]	.033 0.84	6 M3.5	.249 6.32	.312 7.92	.728 18.49	.868 22.05	.125 3.18	Blue	.145 3.68	34898	—

Note: "C" dimension applies from edge of metal wire barrel to center of stud hole.

PLASTI-GRIP Terminals and Splices (Continued)

Spade Tongue Terminals

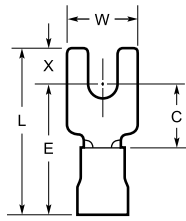

Material
Insulation -Vinyl, UL 94V-0
Terminal Body -Copper per ASTM B-152
Plating -Tin per ASTM B-545

Related Product Data
Insulation Color Code -pg. 4
Packaging Quantities -pg. 4
Performance Specifications -pgs. 4 & 5
Application Tooling -pg. 66

Wire Size Circular Mills [mm ²]	Tongue Material Thickness Max.	Stud Size	Dimensions					Terminal Insulation Color	Wire Insulation Diameter Max.	Part Numbers			
			W	C Min.	E Max.	L Max.	X			Loose Piece	Tape Mounted		
22-16 509-3,260 [0.26-1.65]	.033 0.84	6 M3.5	.250 6.35	.312 7.92	.728 18.49	.858 21.79	.125 3.18	Red	.140 3.56	327043*	2-327043-1		
			.297 7.54	.203 5.16	.619 15.72	.765 19.43	.141 3.58	Red	.125 3.18	327735*	2-327735-1		
			.297 7.54	.203 5.16	.619 15.72	.765 19.43	.141 3.58	Red	.140 3.56	320665*	2-320665-1		
			.307 7.80	.245 6.22	.661 16.79	.836 21.23	.175 4.45	Red	.140 3.56	696003-1	696003-2		
			.375 9.53	.312 7.92	.728 18.49	.920 23.37	.187 4.75	Red	.120 3.18		2-32981-1		
			.375 9.53	.312 7.92	.728 18.49	.920 23.37	.187 4.75	Red	.140 3.56	34155*	2-34155-1		
		8 M4	.033 0.84	10	.375 9.53	.312 7.92	.728 18.49	.920 23.37	.187 4.75	Red	.140 3.56	34156*	2-34156-1
					.237 6.02	.312 7.92	.728 18.49	.865 21.97	.125 3.18	Blue	.145 3.68	696006-1 [†]	—
					.297 7.54	.203 5.16	.619 15.72	.765 19.43	.141 3.58	Blue	.145 3.68	322994*	2-322994-1
					.297 7.54	.203 5.16	.619 15.72	.765 19.43	.141 3.58	Blue	.170 4.32	54367-1	54367-2
					.385 9.78	.312 7.92	.728 18.49	.920 23.37	.187 4.75	Blue	.170 4.32	34165*	—
					.297 7.54	.203 5.16	.619 15.72	.765 19.43	.141 3.58	Blue	.170 4.32	326741	2-326741-1
16-14 2,050-5,180 [1.04-2.62]	.033 0.84	8 M4	.307 7.80	.245 6.22	.661 16.79	.836 21.23	.175 4.45	Blue	.170 4.32	696024-1	696024-2		
			.385 9.78	.312 7.92	.728 18.49	.920 23.37	.187 4.75	Blue	.170 4.32	34166*	2-34166-1		
			.385 9.78	.312 7.92	.728 18.49	.920 23.37	.187 4.75	Blue	.170 4.32	34167*	2-34167-1		
			.237 6.02	.296 7.52	.887 22.53	1.095 27.81	.203 5.16	Yellow	.230 5.84	696007-1 [†]	—		
			.406 10.31	.296 7.52	.887 22.53	1.095 27.81	.203 5.16	Yellow	.230 5.84	34176*	2-34176-1		
			12-10 5,180-13,100 [2.62-6.64]	.042 1.07	10	.237 6.02	.296 7.52	.887 22.53	1.095 27.81	.203 5.16	Yellow	.230 5.84	696007-1 [†]
.406 10.31	.296 7.52	.887 22.53				1.095 27.81	.203 5.16	Yellow	.230 5.84	34176*	2-34176-1		

*Available in small packaging quantities.

[†] Gold

Note: "C" dimension applies from edge of metal wire barrel to center of stud hole.

PLASTI-GRIP Terminals and Splices

PLASTI-GRIP Terminals and Splices (Continued)

Flanged Spade Tongue Terminals

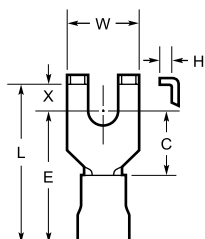

Material
Insulation -Vinyl, UL 94V-0
Terminal Body -Copper per ASTM B-152
Plating -Tin per ASTM B-545

Related Product Data
Insulation Color Code -pg. 4
Packaging Quantities -pg. 4
Performance Specifications - pgs. 4 & 5
Application Tooling -pg. 66

Wire Size Circular Mills [mm ²]	Tongue Material Thickness Max.	Stud Size	Dimensions					Terminal Insulation Color	Wire Insulation Diameter Max.	Part Numbers			
			W	C Min.	E Max.	L Max.	X			H Min.	Loose Piece	Tape Mounted	
22-16 509-3,260 [0.26-1.65]	.033 0.84	6 M3.5	.296	.203	.619	.749	.125	.045	Red	.140 3.56	322249*	1-322249-1	
			7.52	5.16	15.72	19.02	3.18	1.14					
		8 M4	.328	.203	.619	.749	.125	.045	Red	.140 3.56	324560	2-324560-1	
			8.33	5.16	15.72	19.02	3.18	1.14					
			10	.296	.203	.619	.749	.125	.045	Red	.140 3.56	1-322249-0	1-322249-9
				7.52	5.16	15.72	19.02	3.18	1.14				
16-14 2,050-5,180 [1.04-2.62]	.033 0.84	6 M3.5	.294	.203	.619	.749	.125	.047	Blue	.170 4.32	324165*	2-324165-1	
			7.47	5.16	15.72	19.02	3.18	1.19					
		8 M4	.294	.203	.668	.798	.125	.047	Blue	.250 6.35	—	2-324165-4	
			7.47	5.16	16.92	20.27	3.18	1.19					
			10	.416	.250	.666	.842	.171	.062	Blue	.170 4.32	53874-1	53874-2
				10.57	6.35	16.92	21.39	4.34	1.57				
12-10 5,180-13,100 [2.62-6.64]	.042 1.07	6 M3.5	.296	.250	.841	1.017	.171	.052	Yellow	.230 5.84	324581*	1-324581-1	
		7.52	6.35	21.36	25.83	4.34	1.32						
		8 M4	.416	.250	.841	1.017	.171	.052	Yellow	.230 5.84	324172*	1-324172-0	
		10.57	6.35	21.36	25.83	4.34	1.32						
10	.416	.250	.841	1.017	.171	.052	Yellow	.250 6.35	52856	52856-1			

*Available in small packaging quantities.

Note: "C" dimension applies from edge of metal wire barrel to center of stud hole.

PLASTI-GRIP Terminals and Splices (Continued)

**Short Spring Spade
Tongue Terminals**

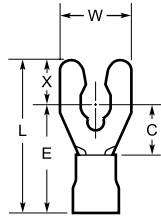

Material

Insulation -Vinyl, UL 94V-0

Terminal Body -Phosphor Bronze per ASTM B-139 for wire sizes 24 to 14
Brass per ASTM B-36 for wire sizes 12 to 10

Plating -Tin per ASTM B-545 except where noted

Related Product Data

Insulation Color Code -pg. 4

Packaging Quantities -pg. 4

Performance Specifications -pgs. 4 & 5

Application Tooling -pg. 66

Wire Size Circular Mils [mm ²]	Tongue Material Thickness Max.	Stud Size	Dimensions					Terminal Insulation Color	Wire Insulation Diameter Max.	Part Numbers	
			W	C Min.	E Max.	L Max.	X			Loose Piece	Tape Mounted
24-20 320-1,290 [0.16-0.65]	.025 0.64	4	.203 5.16	.219 5.56	.624 15.85	.744 18.90	.115 2.92	White	.125 3.18	—	53829-2
			.203 5.16	.250 6.35	.666 16.92	.811 20.60	.140 3.56	Red	.140 3.56	52947*	52947-1
		5 M3	.250 6.35	.250 6.35	.666 16.92	.811 20.60	.140 3.56	Red	.140 3.56	52948*	52948-1
			.234 5.94	.250 6.35	.666 16.92	.811 20.60	.140 3.56	Red	.140 3.56	53240-1*	53240-2
		6 M3.5	.250 6.35	.250 6.35	.666 16.92	.811 20.60	.140 3.56	Red	.140 3.56	52949*	52949-1
			.250 6.35	.250 6.35	.715 18.16	.860 21.84	.140 3.56	Red	.200 5.08	52949-2	52949-3
		8 M4	.244 6.20	.281 7.14	.697 17.70	.872 22.15	.170 4.32	Red	.140 3.56	53241-1	53241-2
			.375 9.53	.281 7.14	.697 17.70	.872 22.15	.170 4.32	Red	.140 3.56	52950*	52950-1
			.375 9.53	.281 7.14	.746 18.95	.921 23.39	.170 4.32	Red	.200 5.08	52950-2	52950-3
			.294 7.47	.281 7.14	.697 17.70	.920 23.37	.218 5.54	Red	.140 3.56	53242-1*	53242-2
		10	.294 7.47	.281 7.14	.746 18.95	.969 24.61	.218 5.54	Red	.200 5.08	53242-5	53242-6
			.406 10.31	.281 7.14	.697 17.70	.920 23.37	.218 5.54	Red	.140 3.56	52951*	52951-1
.406 10.31	.281 7.14		.746 18.95	.969 24.61	.218 5.54	Red	.200 5.08	—	52951-3		
.250 6.35	.250 6.35		.666 16.92	.811 20.60	.140 3.56	Blue	.170 4.32	52955*	52955-1		
6 M3.5	.250 6.35	.250 6.35	.715 18.16	.860 21.84	.140 3.56	Blue	.250 6.35	52955-2	52955-3		
	.250 6.35	.250 6.35	.715 18.16	.860 21.84	.140 3.56	Blue	.250 6.35	52955-4 ¹	—		
8 M4	.244 6.20	.281 7.14	.697 17.70	.872 22.15	.170 4.32	Blue	.170 4.32	53244-1*	53244-2		
	.244 6.20	.281 7.14	.746 18.95	.921 23.39	.170 4.32	Blue	.250 6.35	—	53244-4		
10	.375 9.53	.281 7.14	.697 17.70	.872 22.15	.170 4.32	Blue	.170 4.32	52956*	52956-1		
	.375 9.53	.281 7.14	.746 18.95	.921 23.39	.170 4.32	Blue	.250 6.35	52956-2*	52956-3		
	.294 7.47	.281 7.14	.697 17.70	.920 23.37	.218 5.54	Blue	.170 4.32	53245-1	53245-2		
	.294 7.47	.281 7.14	.746 18.95	.969 24.61	.218 5.54	Blue	.250 6.35	—	53245-6		
10	.406 10.31	.281 7.14	.697 17.70	.920 23.37	.218 5.54	Blue	.170 4.32	52957*	52957-1		
	.406 10.31	.281 7.14	.746 18.95	.969 24.61	.218 5.54	Blue	.250 6.35	52957-2	52957-3		

*Available in small packaging quantities.

¹Terminal body plating — Gold per MIL-G-45204 over Nickel per QQ-N-290.

Note: "C" dimension applies from edge of metal wire barrel to center of stud hole.

PLASTI-GRIP Terminals and Splices (Continued)

**Short Spring Spade
Tongue Terminals**
(Continued)

Wire Size Circular Mills [mm ²]	Tongue Material Thickness Max.	Stud Size	Dimensions					Terminal Insulation Color	Wire Insulation Diameter Max.	Part Numbers			
			W	C Min.	E Max.	L Max.	X			Loose Piece	Tape Mounted		
12-10 5,180-13,100 [2.62-6.64]	.042 1.07	6 M3.5	.250 6.35	.174 4.42	.775 19.69	.959 24.36	.179 4.55	Yellow	.200 5.08	52961*	52961-1		
			.250 6.35	.174 4.42	.775 19.69	.959 24.36	.179 4.55	Yellow	.250 6.35	53246-1*	53246-2		
			.250 6.35	.174 4.42	.775 19.69	.959 24.36	.179 4.55	Yellow	.250 6.35	53246-3 ¹	—		
		8 M4	.312 7.92	.276 7.01	.877 22.28	1.052 26.72	.170 4.32	Yellow	.250 6.35	53247-1*	53247-2		
			.375 9.53	.276 7.01	.877 22.28	1.052 26.72	.170 4.32	Yellow	.200 5.08	52962*	52962-1		
			.375 9.53	.276 7.01	.936 23.77	1.111 28.22	.170 4.32	Yellow	.300 7.62	52962-2	52962-3		
		10	.312 7.92	.276 7.01	.877 22.28	1.100 27.94	.218 5.54	Yellow	.250 6.35	53248-1	53248-2		
			.406 10.31	.276 7.01	.877 22.28	1.100 27.94	.218 5.54	Yellow	.200 5.08	52963	52963-1		
			.406 10.31	.276 7.01	.877 22.28	1.100 27.94	.218 5.54	Yellow	.250 6.35	52963-2*	52963-3		
					.406 10.31	.276 7.01	.936 23.77	1.159 29.44	.218 5.54	Yellow	.300 7.62	52963-4	52963-5

*Available in small packaging quantities.

¹Terminal body plating — Gold per MIL-G-45204 over Nickel per QQ-N-290.

Note: "C" dimension applies from edge of metal wire barrel to center of stud hole.

**Long Spring Spade
Tongue Terminals**

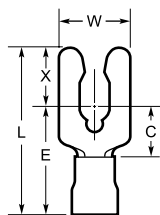

Material

Insulation -Vinyl, UL 94V-0

Terminal Body -Phosphor Bronze per ASTM B-139 for wire sizes 22 to 14
Brass per ASTM B-36 for wire sizes 12 to 10

Plating -Tin per ASTM B-545

Related Product Data

Insulation Color Code -pg. 4

Packaging Quantities -pg. 4

Performance Specifications -pgs. 4 & 5

Application Tooling -pg. 66

Wire Size Circular Mills [mm ²]	Tongue Material Thickness Max.	Stud Size	Dimensions					Terminal Insulation Color	Wire Insulation Diameter Max.	Part Numbers	
			W	C Min.	E Max.	L Max.	X			Loose Piece	Tape Mounted
22-16 509-3,260 [0.26-1.65]	.033 0.84	6 M3.5	.250 6.35	.238 6.05	.664 16.87	.945 24.00	.276 7.01	Red	.140 3.56	52453*	52453-1
			.281 7.14	.270 6.86	.696 17.68	.991 25.17	.290 7.37	Red	.140 3.56	52454*	52454-1
		10	.343 8.71	.283 7.19	.709 18.01	1.017 25.83	.303 7.70	Red	.140 3.56	52455*	52455-1
16-14 2,050-5,180 [1.04-2.62]	.033 0.84	6 M3.5	.250 6.35	.238 6.05	.664 16.87	.945 24.00	.276 7.01	Blue	.170 4.32	52463*	52463-1
			.281 7.14	.270 6.86	.696 17.68	.991 25.17	.290 7.37	Blue	.170 4.32	52464*	52464-1
		10	.343 8.71	.283 7.19	.709 18.01	1.017 25.83	.303 7.70	Blue	.170 4.32	52465*	52465-1
12-10 5,180-13,100 [2.62-6.64]	.042 1.07	8 M4	.375 9.53	.273 6.93	.874 22.20	1.174 29.82	.295 7.49	Yellow	.200 5.08	52474	52474-1
			.375 9.53	.305 7.75	.906 23.01	1.219 30.96	.308 7.82	Yellow	.200 5.08	52475	52475-1
		10	.375 9.53	.305 7.75	.965 24.51	1.278 32.46	.308 7.82	Yellow	.300 7.62	—	52475-3

*Available in small packaging quantities.

Note: "C" dimension applies from edge of metal wire barrel to center of stud hole.

PLASTI-GRIP Terminals and Splices (Continued)

Slotted Ring Tongue Terminals

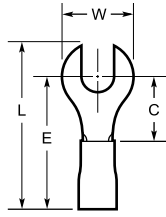

Material
Insulation -Vinyl, UL 94V-0
Terminal Body -Copper per ASTM B-152
Plating -Tin per ASTM B-545

Related Product Data
Insulation Color Code -pg. 4
Packaging Quantities -pg. 4
Performance Specifications - pgs. 4 & 5
Application Tooling -pg. 66

Wire Size Circular Mils [mm ²]	Tongue Material Thickness Max.	Stud Size	Dimensions				Terminal Insulation Color	Wire Insulation Diameter Max.	Part Numbers	
			W	C Min.	E Max.	L Max.			Loose Piece	Tape Mounted
22-16 509-3,260 [0.26-1.65]	.033 0.84	6	.218	.156	.572	.658	Red	.125 3.18	34090	—
		M3.5	5.54	3.96	14.53	16.71				
		8	.281	.250	.666	.782	Red	.140 3.56	324184	2-324184-1
		M4	7.14	6.35	16.92	19.86				

Note: "C" dimension applies from edge of metal wire barrel to center of stud hole.

PLASTI-GRIP Terminals and Splices

Hook Tongue Terminals

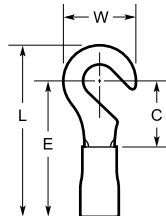

Material
Insulation -Vinyl, UL 94V-0
Terminal Body -Copper per ASTM B-152
Plating -Tin per ASTM B-545

Related Product Data
Insulation Color Code -pg. 4
Packaging Quantities -pg. 4
Performance Specifications - pgs. 4 & 5
Application Tooling -pg. 66

Wire Size Circular Mils [mm ²]	Tongue Material Thickness Max.	Stud Size	Dimensions				Terminal Insulation Color	Wire Insulation Diameter Max.	Part Numbers	
			W	C Min.	E Max.	L Max.			Loose Piece	Tape Mounted
16-14 2,050-5,180 [1.04-2.62]	.033 0.84	8 M4	.343 8.71	.281 7.14	.697 17.70	.871 22.12	Blue	.170 4.32	320263	2-320263-1

Note: "C" dimension applies from edge of metal wire barrel to center of stud hole.

PLASTI-GRIP Terminals and Splices (Continued)

Flag Tongue Terminals

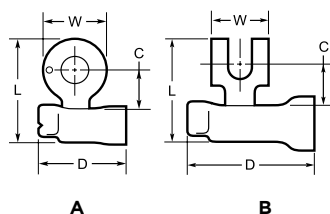

Material
Insulation -Vinyl, UL 94V-0
Color -Natural
Terminal Body -Copper per ASTM B-152
Plating -Tin per ASTM B-545

Related Product Data
Insulation Color Code -pg. 4
Packaging Quantities -pg. 4
Performance Specifications -pgs. 4 & 5
Application Tooling -pg. 66

Wire Size Circular Mills [mm ²]	Tongue Material Thickness Max.	Style	Stud Size	Dimensions				Terminal Insulation Stripe Color	Wire Insulation Diameter Max.	Part Numbers	
				W	C Min.	L Max.	D Max.			Loose Piece	Tape Mounted
20-16HD ¹ 810-3,260 [0.41-1.65]	.042 1.07	A	14	.500 12.70	.266 6.76	.749 19.02	.695 17.65	Green	.170 4.32		322307
16-14 2,050-5,180 [1.04-2.62]	.033 0.84	B	10	.385 9.78	.272 6.91	.741 18.82	.695 17.65	Blue	.170 4.32		322834
		A	14	.500 12.70	.266 6.76	.749 19.02	.695 17.65	Blue	.170 4.32		322310
16-14HD ¹ 2,050-5,180 [1.04-2.62]	.050 1.27	A	10	.500 12.70	.266 6.76	.810 20.57	.775 19.69	Black	.230 5.84		322312
			14	.500 12.70	.266 6.76	.810 20.57	.775 19.69	Black	.230 5.84		322313
12-10 5,180-13,100 [2.62-6.64]	.042 1.07	A	10	.500 12.70	.266 6.76	.812 20.62	.775 19.69	Yellow	.230 5.84		322315
			14	.500 12.70	.266 6.76	.812 20.62	.775 19.69	Yellow	.230 5.84		322316
			14	.500 12.70	.266 6.76	.812 20.62	.775 19.69	Yellow	.280 7.11		322395

¹Heavy Duty for extra mechanical strength.

Multiple Stud Terminals

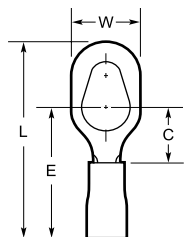

Material
Insulation -Vinyl, UL 94V-0
Terminal Body -Copper per ASTM B-152
Plating -Tin per ASTM B-545

Related Product Data
Insulation Color Code -pg. 4
Packaging Quantities -pg. 4
Performance Specifications -pgs. 4 & 5
Application Tooling -pg. 66

Wire Size Circular Mills [mm ²]	Tongue Material Thickness Max.	Stud Size	Dimensions				Terminal Insulation Color	Wire Insulation Diameter Max.	Part Numbers	
			W	C Min.	E Max.	L Max.			Loose Piece	Tape Mounted
22-16 509-3,260 [0.26-1.65]	.033 0.84	6-8-10	.325 8.26	.271 6.88	.691 17.55	.969 24.61	Red	.125 3.18	54774-1	54774-2
16-14 2,050-5,180 [1.04-2.62]	.033 0.84	6-8-10	.325 8.26	.271 6.88	.691 17.55	.969 24.61	Blue	.145 3.68	54775-1	54775-2

Note: "C" dimension applies from edge of metal wire barrel to center of stud hole.

PLASTI-GRIP Terminals and Splices (Continued)

Butt Splices

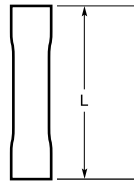

Material
Insulation -Vinyl, UL 94V-0
Splice Body -Copper per ASTM B-152
Plating -Tin per ASTM B-545

Related Product Data
Insulation Color Code -pg. 4
Packaging Quantities -pg. 4
Performance Specifications -pgs. 4 & 5
Application Tooling -pg. 66

Wire Size Circular Mills ¹ [mm ²]	Dimension L Max.	Splice Insulation Color	Wire Insulation Diameter Max.	Part Numbers	
				Loose Piece	Tape Mounted
26-22 202-810 [0.10-0.41]	.620 15.75	Yellow	.080 2.03	321026* ¹	2-321026-1 ¹
22-18/16-14	1.065 27.05	Red/Blue Stripe	.170 / .115 6.86/ 2.92	696010-1	—
22-16 ² 509-3,260 [0.26-1.65]	1.065 27.05	Red	.120 3.05	34067*	2-34067-1
	1.065 27.05	Red	.170 4.32	34243*	1-34243-1
	1.076 27.33	Natural w/ Red Letters	.120 3.05	324138*	—
	1.076 27.33	Red	.140 3.56	34070*	1-34070-1
	1.076 27.33	Natural w/ Red Stripes	.140 3.56	55792-1*	55792-2
	1.065 27.05	Red	.083 x .171 2.11 x 4.34	34203 ^{3*}	—
16-14 2,050-5,180 [1.04-2.62]	.600 15.24	Blue	—	55629-2	—
	1.065 27.05	Blue	.140 3.56	34068*	2-34068-1
	1.065 27.05	Natural w/ Blue Letters	.140 3.56	328427*	—
	1.065 27.05	Blue	.170 4.32	34071*	2-34071-1
	1.065 27.05	Natural w/ Blue Stripes	.170 4.32	55785-1*	55785-2
	1.065 27.05	Blue	.215 5.46	35244*	2-35244-1
	1.105 28.07	Blue	.170 4.32	2-34071-2 ⁴	2-34071-3 ⁴
	1.065 27.05	Blue	.135 x .245 3.43 x 6.22	34204 ^{3*}	1-34204-0
12-10 5,180-13,100 [2.62-6.64]	1.160 29.46	Yellow	.200 5.08	34069	—
	1.160 29.46	Yellow	.230 5.84	34072*	2-34072-2
	1.160 29.46	Natural w/ Yellow Stripes	.230 5.84	55793-1*	55793-2
	1.160 29.46	Yellow	.250 6.35	34945*	—
	1.160 29.46	Yellow	.300 7.62	326742	—
	1.200 30.48	Yellow	.250 6.35	2-34945-1 ⁴	2-34945-2 ⁴
	1.160 29.46	Yellow	.250 / .165 x .315 6.35 / 4.19 x 8.00	321286 ^{5†}	—
	1.160 29.46	Yellow	.138 x .281 3.51 x 7.14	34205 ^{3*}	—
8	1.340 34.04	Red	.250 6.35	696025-1	—
6	1.530 38.86	Blue	.330 8.38	696026-1	—

[†] Not UL or CSA Approved or Listed.

*Available in small packaging quantities.

¹When using two or more wires in either end of a butt splice, the combined cross sectional area must be within the (CMA) circular mil range listed. (Not UL or CSA approved with use of multiple wires.)

²22-16 splices are 22-18 range in accordance with MIL-T-7928.

³Oval expansion.

⁴Funnel entry

⁵Oval expansion at one end; circular expansion at other end.

PLASTI-GRIP Terminals and Splices

PLASTI-GRIP Terminals and Splices (Continued)

Parallel Splices

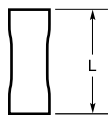

Material
Insulation -Vinyl, UL 94V-0
Splice Body -Copper per ASTM B-152
Plating -Tin per ASTM B-545

Related Product Data
Insulation Color Code -pg. 4
Packaging Quantities -pg. 4
Performance Specifications -pgs. 4 & 5
Application Tooling -pg. 66

Wire Size Circular Mils ¹ [mm ²]	Dimension L Max.	Splice Insulation Color	Wire Insulation Diameter Max.	Part Numbers Loose Piece
22-16 509-3,260 [0.26-1.65]	.760 19.30	Red	.120 3.05	34131*
	.760 19.30	Red	.140 3.56	34132*
	.760 19.30	Blue	.140 3.56	34133*
16-14 2,050-5,180 [1.04-2.62]	.760 19.30	Blue	.170 4.32	34134*
	.760 19.30	Blue	.135 x .245 3.43 x 6.22	34207 ^{2*}
12-10 5,180-13,100 [2.62-6.64]	.843 21.41	Yellow	.200 5.08	34135
	.870 22.10	Yellow	.230 5.84	34136*

*Available in small packaging quantities.

¹When using two or more wires in a parallel splice, the combined cross sectional area must be within the (CMA) circular mil area listed.

²Oval expansion.

Shur-Plug

(.093, .156 and .180 Series)

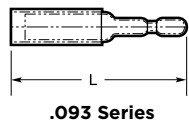

.093 Series

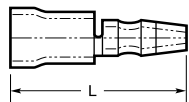

.156 Series

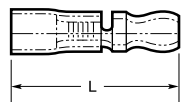

.180 Series

Material (.093 Series)
Insulation -Vinyl, UL 94V-0
Terminal Body -Brass per ASTM B-36

Material
 (.156 & .180 Series)
Insulation -Vinyl, UL 94V-0
Terminal Body -Copper per ASTM B-152
Plating -Tin per ASTM B-545

Related Product Data
Insulation Color Code -pg. 4
Packaging Quantities -pg. 4
Performance Specifications -pgs. 4 & 5
Application Tooling -pg. 66

Wire Size Circular Mils [mm ²]	Tongue Material Thickness Max.	Series	Dimension L Max.	Terminal Insulation Color	Wire Insulation Diameter Max.	Part Numbers	
						Loose Piece	Tape Mounted
22-16 509-3,260 [0.26-1.65]	—	.093	.812 20.62	Red	.140 3.56	34178	—
16-14 2,050-5,180 [1.04-2.62]	.033 0.84	.156	.800 20.32	Blue	.170 4.32	324227 [†]	1-324227-0
		.180	.753 19.13	Blue	.170 4.32	324228 [†]	—

[†] Not UL or CSA Approved or Listed.

*Available in small packaging quantities.

PLASTI-GRIP Terminals and Splices (Continued)

3-Way Connector

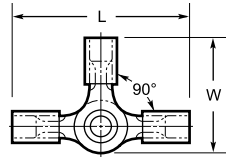

Material
Insulation -Vinyl, UL 94V-0
Terminal Body -Copper per ASTM B-152
Rivet -Brass per QQ-B-626
Plating -Tin per ASTM B-545

Related Product Data
Insulation Color Code -pg. 4
Packaging Quantities -pg. 4
Performance Specifications -pgs. 4 & 5
Application Tooling -pg. 66

Wire Size Circular Mils [mm ²]	Tongue Material Thickness Max.	Dimensions		Terminal Insulation Color	Wire Insulation Diameter Max.	Part Number Loose Piece
		W Max.	L Max.			
16-14 2,050-5,180 [1.04-2.62]	.033 0.84	.877 22.28	1.400 35.56	Blue	.145 3.68	34073*

*Available in small packaging quantities.

.250 Tube Cap Assembly

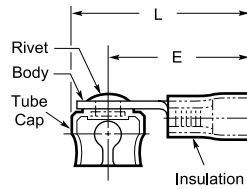

Material
Insulation -Vinyl, UL 94V-0
Terminal Body -Copper per ASTM B-152
Plating -Tin per ASTM B-545
Tube Cap -Copper/Zinc alloy per MIL-C-50
Plating -Tin per ASTM B-545
Rivet -Brass
Plating -Tin per ASTM B-545 over Copper

Related Product Data
Insulation Color Code -pg. 4
Packaging Quantities -pg. 4
Performance Specifications -pgs. 4 & 5
Application Tooling -pg. 66

Wire Size Circular Mils [mm ²]	Tongue Material Thickness Max.	Dimensions		Terminal Insulation Color	Wire Insulation Diameter Max.	Part Number Loose Piece
		E Max.	L Max.			
22-16 509-3,260 [0.26-1.65]	.033 0.84	.666 16.92	.978 24.84	Black	.140 3.56	55137-1†

† Not UL or CSA Approved or Listed.

Wire Pins

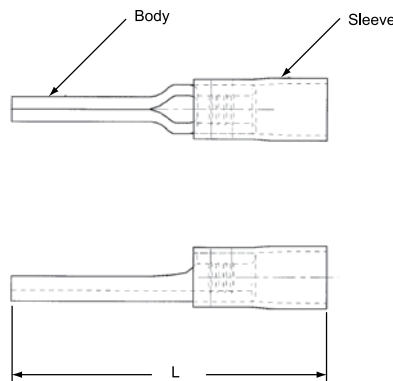

Wire Size Circular Mils [mm ²]	Tab	Dimensions		Terminal Insulation Color	Wire Insulation Diameter Max.	Part Number
		Ins.	L Max.			
22-16	.070 1.78	.140 3.56	.943 23.95	Red	.145 3.68	696116-1 (Tape)
	.071 1.80	.135 3.43	.905 22.99	Red	.145 3.68	165167 (Loose Piece)

TERMINYL Terminals and Splices

Product Facts

- Designed to provide insulated terminals and splices for large wire sizes, many of which are used in airborne and ground support applications
- Tested under the procedures stipulated by MIL Spec. MIL-T-7928, they meet and exceed requirements
- Designed and engineered to withstand extreme vibration, shock and structural stresses, elevated temperatures and other conditions which could adversely affect the circuit requirements in complex air and space flight equipment
- The use of matching AMP tooling provides for precision crimping which makes all terminations identical
- This uniformity promotes maximum reliability and, coupled with tool die marks on the barrel indicating the wire size and color coding of the insulation sleeve, also serves as a built-in quality control factor
- Pre-insulated with color coded nylon which also acts as insulation support
- Wire size range of terminals is 8 AWG through 4/0 AWG

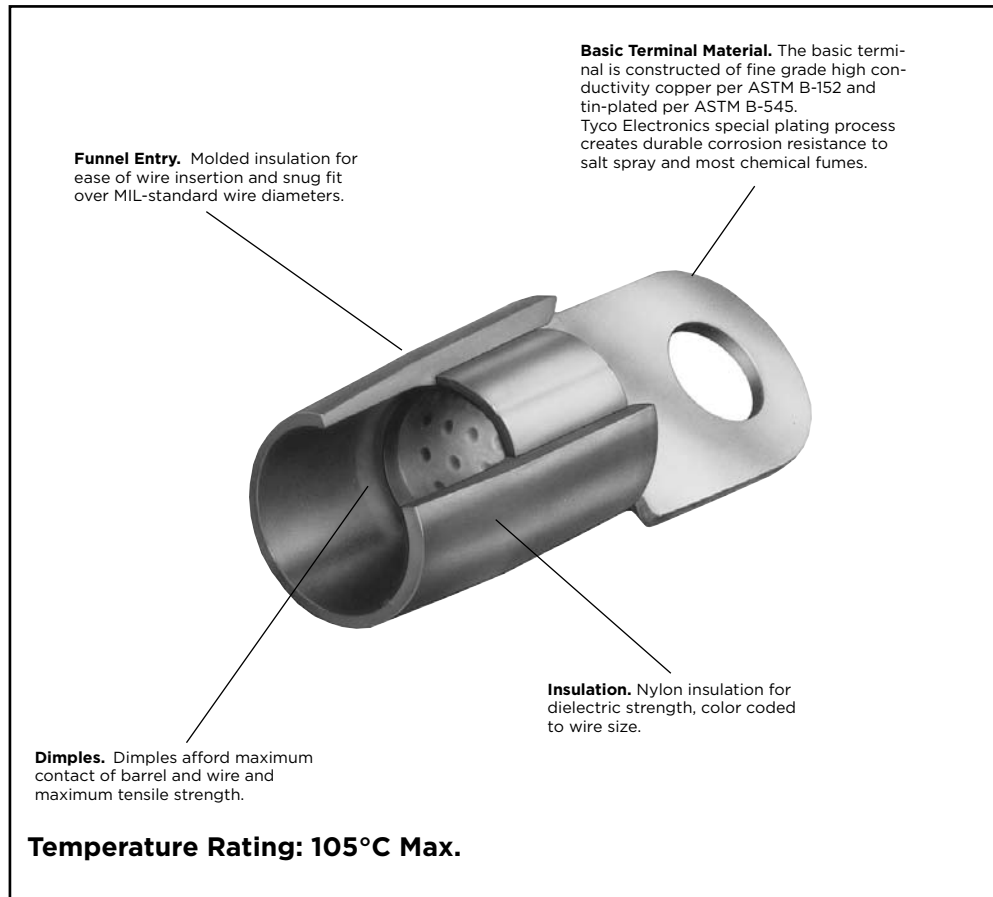

TERMINYL Terminals meet or exceed the requirements of MIL-T-7928, Type II, Class 2. Refer to AMP Qualified Products for Military Application, Catalog 73-159 for Military Specification Number to AMP Part Number cross reference.

TERMINYL Terminals and Splices (Continued)

Ring Tongue Terminals

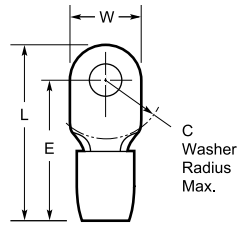

Material
Insulation -Nylon, UL 94V-2
Terminal Body -Copper per ASTM B-152
Plating -Tin per ASTM B-545

Related Product Data
Insulation Color Code -pg. 4
Packaging Quantities -pg. 4
Performance Specifications -pgs. 4 & 5
Application Tooling -pg. 67

Wire Size Circular Mils [mm ²]	Tongue Material Thickness Max.	Stud Size	Dimensions				Terminal Insulation Color	Wire Insulation Diameter Max.	Part Numbers Loose Piece
			W	C	E Max.	L Max.			
8 13,100-20,800 [6.64-10.5]	.043 1.09	8 M4	.478 12.14	.437 11.10	1.183 30.05	1.425 36.20	Red	.256 6.50	53041
		10	.431 10.95	.437 11.10	1.183 30.05	1.402 35.61	Red	.256 6.50	324043
		1/4 M6	.478 12.14	.437 11.10	1.183 30.05	1.425 36.20	Red	.256 6.50	324082
		5/16 M8	.587 14.91	.500 12.70	1.246 31.65	1.542 39.17	Red	.256 6.50	324044
		3/8	.587 14.91	.500 12.70	1.246 31.65	1.542 39.17	Red	.256 6.50	324045
6 20,800-33,100 [10.5-16.8]	.048 1.22	10	.398 10.11	.515 13.08	1.447 36.75	1.700 43.18	Blue	.314 7.98	53119-1 ¹
		10	.468 11.89	.421 10.69	1.338 33.99	1.575 40.01	Blue	.314 7.98	324046
		1/4 M6	.500 12.70	.515 13.08	1.447 36.75	1.700 43.18	Blue	.314 7.98	324047
		5/16 M8	.625 15.88	.515 13.08	1.447 36.75	1.762 44.75	Blue	.314 7.98	324048
		3/8	.625 15.88	.515 13.08	1.447 36.75	1.762 44.75	Blue	.314 7.98	324049
4 33,100-52,600 [16.8-26.7]	.051 1.30	8 M4	.437 11.10	.265 6.73	1.155 29.34	1.376 34.95	Yellow	.382 9.70	331456
		10	.437 11.10	.265 6.73	1.155 29.34	1.376 34.95	Yellow	.382 9.70	1-331456-0
		10	.546 13.87	.531 13.49	1.536 39.01	1.812 46.02	Yellow	.382 9.70	324111
		1/4 M6	.546 13.87	.531 13.49	1.536 39.01	1.812 46.02	Yellow	.382 9.70	324050
		5/16 M8	.679 17.25	.531 13.49	1.536 39.01	1.878 47.70	Yellow	.382 9.70	324051
		3/8	.679 17.25	.531 13.49	1.536 39.01	1.878 47.70	Yellow	.382 9.70	324052*
		1/2 M12	.679 17.25	.531 13.49	1.536 39.01	1.878 47.70	Yellow	.382 9.70	324114
4HD ³ 33,100-52,600 [16.8-26.7]	.094 2.39	1/4 M6	.500 12.70	.390 9.91	1.349 34.26	1.602 40.69	Yellow	.443 11.25	330966
		5/16 M8	.679 17.25	.456 11.58	1.565 39.75	1.907 48.44	Yellow	.443 11.25	1-331421-0
		3/8	.679 17.25	.456 11.58	1.565 39.75	1.907 48.44	Yellow	.443 11.25	1-331421-1
2 52,600-83,700 [26.7-42.4]	.060 1.52	10	.711 18.06	.578 14.68	1.705 43.31	2.063 52.40	Red	.468 11.89	328655
		1/4 M6	.679 17.25	.578 14.68	1.705 43.31	2.045 51.94	Red	.468 11.89	324053
		5/16 M8	.711 18.06	.578 14.68	1.705 43.31	2.063 52.40	Red	.468 11.89	324112
		3/8	.711 18.06	.578 14.68	1.705 43.31	2.063 52.40	Red	.468 11.89	324054
		1/2 M12	.855 21.72	.578 14.68	1.705 43.31	2.135 54.23	Red	.468 11.89	324055

*Available in small packaging quantities.

¹Rectangular tongue terminal

²90° bend ring tongue terminal

³Heavy duty for extra mechanical strength.

TERMINYL Terminals and Splices

TERMINYL Terminals and Splices (Continued)

Ring Tongue Terminals

(Continued)

Wire Size Circular Mils [mm ²]	Tongue Material Thickness Max.	Stud Size	Dimensions				Terminal Insulation Color	Wire Insulation Diameter Max.	Part Numbers	
			W	C	E Max.	L Max.			Loose Piece	
1/0 83,700-119,500 [42.4-60.6]	.073 1.85	1/4 M6	.675 17.15	.625 15.88	2.033 51.64	2.360 59.94	Blue	.580 14.73	55822-1	
			.807 20.50	.625 15.88	2.033 51.64	2.426 61.62	Blue	.580 14.73	324056	
		5/16 M8	.807 20.50	.625 15.88	2.033 51.64	2.426 61.62	Blue	.580 14.73	324113	
			.807 20.50	.625 15.88	2.033 51.64	2.426 61.62	Blue	.580 14.73	324057	
		1/2 M12	.875 22.23	.625 15.88	2.017 51.23	2.454 62.33	Blue	.580 14.73	324058	
2/0 119,500-150,500 [60.6-76.3]	.083 2.11	5/16 M8	.926 23.52	.625 15.88	2.026 51.46	2.416 61.37	Yellow	.610 15.49	324083	
		3/8	.926 23.52	.625 15.88	2.026 51.46	2.416 61.37	Yellow	.610 15.49	324084	
		1/2 M12	.926 23.52	.625 15.88	2.026 51.46	2.416 61.37	Yellow	.610 15.49	324085	
3/0 150,500-190,000 [76.3-96.3]	.094 2.39	3/8	1.082 27.48	.625 15.88	2.294 58.27	2.794 70.97	Red	.680 17.27	324185	
4/0 190,000-231,100 [96.3-117]	.105 2.67	3/8	.835 21.21	.625 15.88	2.295 58.29	2.700 68.58	Blue	.765 19.43	329150	
			1.150 29.21	.625 15.88	2.295 58.29	2.858 72.59	Blue	.765 19.43	324187	
		1/2 M12	1.150 29.21	.625 15.88	2.295 58.29	2.858 72.59	Blue	.765 19.43	324188	

TERMINYL Terminals and Splices (Continued)

Butt Splices

Material

Insulation Sleeve -Nylon, UL 94V-2

Splice Body -Copper per ASTM B-152

Plating -Tin per ASTM B-545

Related Product Data

Insulation Color Code -pg. 4

Packaging Quantities -pg. 4

Performance Specifications - pgs. 4 & 5

Application Tooling -pg. 67

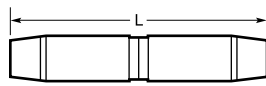

Single to single-
Standard splice or
step down assembly

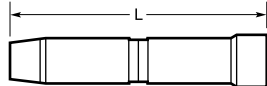

Single to multiple
Standard splice

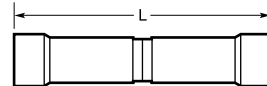

Multiple to Multiple
Standard splice

Wire Size Circular Mils [mm ²]	Style	Dimension L Max.	Splice Insulation Color	Wire Insulation Diameter Max.		Part Numbers
				Single End	Multiple End	
8 to 12-10 13,100-20,800 [6.64-10.5] to 5,180-13,100 [2.62-6.64]	Single to Single Step-Down Assembly	2.066 52.48	Red w/ Yellow at adapter end	.255 6.48	—	328569
6 to 8 20,800-33,100 [10.5-16.8] to 13,100-20,800 [6.64-10.5]	Single to Single Step-Down Assembly	2.265 57.53	Blue w/ Red at adapter end	.310 7.87	—	328571
8 13,100-20,800 [6.64-10.5]	Single to Single Standard Splice	2.066 52.48	Red	.255 6.48	—	324625
6 20,800-33,100 [10.5-16.8]		2.265 57.53	Blue	.310 7.87	—	324660
4 33,100-52,600 [16.8-26.7]		2.804 71.22	Yellow	.370 9.40	—	324622
2 52,600-83,700 [26.7-42.4]		3.094 78.59	Red	.445 11.30	—	324623
8 13,100-20,800 [6.64-10.5]	Single to Multiple Standard Splice	2.171 55.14	Red	.255 6.48	.335 8.51	324658
6 20,800-33,100 [10.5-16.8]		2.359 59.92	Blue	.310 7.87	.415 10.54	324621
4 33,100-52,600 [16.8-26.7]		2.804 71.22	Yellow	.370 9.40	.495 12.57	324662
8 13,100-20,800 [6.64-10.5]	Multiple to Multiple Standard Splice	2.276 57.81	Red	—	.335 8.51	324657
6 20,800-33,100 [10.5-16.8]		2.484 63.09	Blue	—	.415 10.54	324659
2 52,600-83,700 [26.7-42.4]		3.094 78.59	Red	—	.595 15.11	324663

¹Step-Down Assembly includes adapter which is visible through insulation sleeve window.

CERTI-SEAL Terminals and Splices

Product Facts

- Nylon window splice for military, commercial, aircraft, and missile applications that seals out vapors and fluids and imparts exceptional wire insulation support
- Metal rings at both ends of splice and permanently crimped to wire insulation for a moisture tight seal, even at altitude
- Designed to fit more than 100 insulation diameters in MIL-Spec wires from #24 to #10 AWG, and is available in three types
- First type is made with a nylon ring adapter within the wire entrance
- Second type, without nylon ring adapters
- Third type with a nylon ring adapter in one end only
- Special notch feature on the outside of the splice allows locator in the crimping tool to precisely position splice before crimping and to prevent twisting or horizontal movement during crimping
- Window area of each splice permits visual inspection of the linear plane of the crimp in relation to the inner metal sleeve
- Wire-stops in splice barrel indicate exact insertion depth of stripped wire-ends

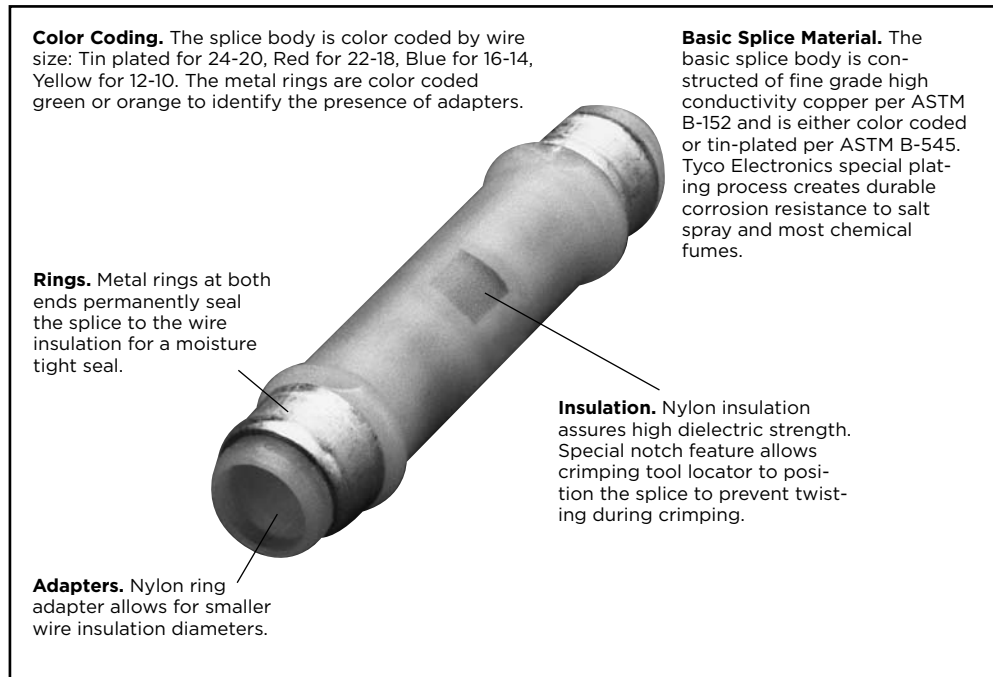

CERTI-SEAL Terminals and Splices (Continued)

Splice

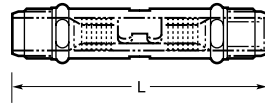

Material

Insulation -Nylon, UL 94V-2

Splice Body -Copper per ASTM B-152

Plating -Tin per ASTM B-545 or Zinc Plate/Dye Chromate

Related Product Data

Insulation Color Code -pg. 4

Packaging Quantities -pg. 4

Performance Specifications -pgs. 4 & 5

Application Tooling -shown below

Splices with nylon wire insulation diameter adapters

Wire Size Circular Mills [mm ²]	L Max.	Body Color	Ring Color	Wire Insulation Dia. Max.	Part Numbers	Hand Tool Part No.
24-20 320-1,290 [0.16-0.65]	.970 24.64	Tin Plated	Green	.065 1.65	324987	46073
24-20 320-1,290 [0.16-0.65]	.970 24.64	Tin Plated	Orange	.073 1.85	1-324987-0	46073
22-18 509-1,900 [0.26-0.96]	1.156 29.36	Red	Green	.101 2.57	324988	46074
16-14 2,050-5,180 [1.04-2.62]	1.156 29.36	Blue	Green	.120 3.05	324989	59282
12-10 5,180-13,100 [2.62-6.64]	1.345 34.16	Yellow	Green	.150 3.81	324990	58325-1

Splices without nylon wire insulation diameter adapters

Wire Size Circular Mills [mm ²]	L Max.	Body Color	Ring Color	Wire Insulation Dia. Max.	Part Numbers	Hand Tool Part No.
24-20 320-1,290 [0.16-0.65]	.970 24.64	Tin Plated	Tin Plated	.100 2.54	324544	46073
22-18 509-1900 [0.26-0.96]	1.156 29.36	Red	Tin Plated	.133 3.38	324548	46074
16-14 2,050-5,180 [1.04-2.62]	1.156 29.36	Blue	Tin Plated	.157 3.99	324549	59282
12-10 5,180-13,100 [2.62-6.64]	1.345 34.16	Yellow	Tin Plated	.218 5.54	324631	58325-1
16-14 HD	1.345 34.16	Tin Plated	Tin Plated	.218 5.54	55685-1	58325-1

Splices with nylon wire insulation diameter adapter in one end

Wire Size Circular Mills [mm ²]	L Max.	Body Color	Ring Color	Wire Insulation Dia. Max.		Part Number	Hand Tool Part No.
				Adapter End	Other End		
24-20 320-1,290 [0.16-0.65]	.970 24.64	Tin Plated	Orange & Tin Plated	.073 1.85	.100 2.54	1-324987-1	46073

Tooling



Tool Part No. 46073 or 46074



Tool Part No. 59282 or 58325-1

Hand tooling features the AMP CERTI-CRIMP ratchet so that the operator fully closes tool so that crimping dies in tool head fully “bottom”. Locator feature in head assures that splice is properly oriented in tool. CERTI-SEAL Tools do not require wire insulation adjustment prior to crimping.

Class 1 and Class 2 Military Approvals

Approval	Dimensional Requirement	Application Tooling	Use	Performance Requirement
Class 1	Terminals must comply with the dimensional requirements specified by the military.	Hand application tool which must conform to the military's dimensional and performance specification.	For procurement by government agencies for maintenance and repair.	
Class 2	Terminals must comply with the dimensional requirements specified by the manufacturer's customer drawing. For field repair purposes Class 2 terminals must be capable of being replaced by Class 1 Terminals.	The terminal manufacturers recommended application tooling. Note: Several tape mounted part numbers are currently Class 2 approved.	For procurement by contractors and manufacturers for high volume production, modification, and repair.	Per Military Specification Mil-T-7928G

Military Specifications MS 25036

AWG	MS25036 Dash Numbers	PIDG Part Numbers		Class	Stud Size
		Loose Piece	Tape Mounted		
22-18	101	36149	—	1 & 2	6
		—	2-36149-2	2	6
	102	36150	—	1 & 2	6
		—	2-36150-1	2	6
	103	51863	—	1 & 2	6
		—	51863-1	2	6
	104	36153	—	1 & 2	10
		—	2-36153-2	2	10
	105	36154	—	1 & 2	10
		—	2-36154-2	2	10
	106	31895	—	1 & 2	5/16
		—	2-31895-1	2	5/16
	107	320572	—	1 & 2	5/16
		—	2-320572-1	2	5/16
108	31897	—	1 & 2	3/8	
	—	2-31897-2	2	3/8	
109	320573	—	1 & 2	3/8	
	—	2-320573-4	2	3/8	
110	320561	—	1 & 2	6	
	—	2-320561-2	2	6	
111	51864	—	1 & 2	6	
	—	51864-3	2	6	
112	51864-2	—	1 & 2	10	
	—	51864-4	2	10	
113	320575	—	1 & 2	5/16	
	—	2-320575-1	2	5/16	
114	320564	—	1 & 2	3/8	
	—	2-320564-3	2	3/8	
12-10	35107	—	1 & 2	6	
	—	2-35107-1	2	6	
12-10	320567	—	1 & 2	6	
	—	2-320567-2	2	6	
12-10	35109	—	1 & 2	10	
	—	2-35109-1	2	10	
12-10	36161	—	1 & 2	10	
	—	2-36161-2	2	10	
12-10	35111	—	1 & 2	5/16	
	—	2-35111-1	2	5/16	
12-10	320576	—	1 & 2	5/16	
	—	2-320576-1	2	5/16	
12-10	35112	—	1 & 2	3/8	
	—	2-35112-1	2	3/8	
12-10	320577	—	1 & 2	3/8	
	—	2-320577-3	2	3/8	

Class 1 and Class 2 Military Approvals (Continued)

**Military Specifications
MS 25036**

(Continued)

AWG	MS25036 Dash Numbers	TERMINYL Part Numbers		Class	Stud Size
		Loose Piece	Tape Mounted		
8	115	324043	—	2	10
	116	324082	—	2	1/4
	117	324044	—	2	5/16
	118	324045	—	2	3/8
	119	324046	—	2	10
6	120	324047	—	2	1/4
	121	324048	—	2	5/16
	122	324049	—	2	3/8
4	123	324050	—	2	1/4
	124	324051	—	2	5/16
	125	324052	—	2	3/8
	126	324053	—	2	1/4
2	127	324054	—	2	3/8
	128	324055	—	2	1/2
	129	324056	—	2	1/4
1 ¹	130	324057	—	2	3/8
	131	324058	—	2	1/2
1/0	132	324056	—	2	1/4
	133	324057	—	2	3/8
	134	324058	—	2	1/2
2/0	135	324083	—	2	5/16
	136	324084	—	2	3/8
	137	324085	—	2	1/2
3/0	138	324185	—	2	3/8
4/0	140	324187	—	2	3/8
	141	324188	—	2	1/2

¹Tyco Electronics recommends #1/0 AWG terminals for #1 AWG application.

Class 1 and Class 2 Military Approvals (Continued)

**Military Specifications
MS 25036**

(Continued)

AWG	MS25036 Dash Numbers	PIDG Part Numbers		Class	Stud Size	
		Loose Piece	Tape Mounted			
26-24	143	54310-1	—	1 & 2	2	
		323913	—	2	2	
	144	52189	—	1 & 2	4	
		323914	2-323914-1	2	4	
	145	53073	—	1 & 2	6	
		326875	2-326875-1	2	6	
	146	54311-1	—	1 & 2	8	
		323916	2-323916-1	2	8	
	147	54312-1	—	1 & 2	10	
		—	54312-2	2	10	
	22-18	148	324075	2-324075-1	2	10
			31880	—	1 & 2	4
149		—	2-31880-1	2	4	
		320553	—	1 & 2	4	
150		—	2-320553-2	2	4	
		31890	—	1 & 2	8	
151		—	2-31890-1	2	8	
		320551	—	1 & 2	8	
152		—	1-320551-1	2	8	
		31894	—	1 & 2	1/4	
153		—	2-31894-2	2	1/4	
		320571	—	1 & 2	1/4	
16-14	154	—	2-320571-2	2	1/4	
		328975	—	1 & 2	1/2	
	155	324159	—	1 & 2	4	
		51864-1	—	1 & 2	8	
	156	—	51864-5	2	8	
		320563	—	1 & 2	1/4	
	157	—	2-320563-2	2	1/4	
		328976	—	1 & 2	1/2	
	158	35108	—	1 & 2	8	
		—	2-35108-1	2	8	
	12-10	320568	—	1 & 2	8	
		—	2-320568-1	2	8	
12-10	35110	—	1 & 2	1/4		
	—	2-35110-1	2	1/4		
12-10	157	320569	—	1 & 2	1/4	
	—	2-320569-3	2	1/4		
12-10	158	52077	—	2	1/2	

Military Approvals

Class 1 and Class 2 Military Approvals (Continued)

**Military Specifications
M7928/1**

AWG	M7928/1 Dash Numbers	PIDG-Insulation Restricting		Class	Stud Size
		Part Numbers			
		Loose Piece	Tape Mounted		
26	1	53078	—	1 & 2	2
	2	53049	—	1 & 2	4
	3	53050	—	1 & 2	6
	4	53051	—	1 & 2	8
	5	53052	—	1 & 2	10
24	6	53053	—	1 & 2	2
	7	53054	—	1 & 2	4
	8	53055	—	1 & 2	6
	9	53056	—	1 & 2	8
	10	53057	—	1 & 2	10
22	11	52273	—	1 & 2	4
	12	2-36149-3	—	1 & 2	6
	13	51863-2	—	1 & 2	6
		—	51863-5	2	6
	14	1-320551-2	—	1 & 2	8
		—	1-320551-5	2	8
	15	2-36153-3	—	1 & 2	10
		—	2-36153-6	2	10
	16	2-320571-3	—	1 & 2	1/4
	17	2-320572-2	—	1 & 2	5/16
18	2-320573-1	—	1 & 2	3/8	
19	2-328975-1	—	1 & 2	1/2	
20	20	52273-1	—	1 & 2	4
	21	2-36149-4	—	1 & 2	6
	22	51863-3	—	1 & 2	6
		—	51863-6	2	6
	23	1-320551-3	—	1 & 2	8
	24	2-36153-4	—	1 & 2	10
		—	2-36153-8	2	10
	25	2-320571-4	—	1 & 2	1/4
	26	2-320572-3	—	1 & 2	5/16
	27	2-320573-2	—	1 & 2	3/8
28	2-328975-2	—	1 & 2	1/2	
18	29	52273-2	—	1 & 2	4
	30	2-36149-5	—	1 & 2	6
	31	51863-4	—	1 & 2	6
		—	51863-7	2	6
	32	1-320551-4	—	1 & 2	8
		—	1-320551-8	2	8
	33	2-36153-5	—	1 & 2	10
		—	2-36153-9	2	10
	34	2-320571-5	—	1 & 2	1/4
	35	2-320572-4	—	1 & 2	5/16
36	2-320573-3	—	1 & 2	3/8	
37	2-328975-3	—	1 & 2	1/2	
16	38	52274	—	1 & 2	4
	39	2-320561-3	—	1 & 2	6
	40	51864-6	—	1 & 2	6
		—	1-51864-2	2	6
	41	1-51864-0	—	1 & 2	8
	42	51864-7	—	1 & 2	10
		—	1-51864-3	2	10
	43	2-320563-3	—	1 & 2	1/4
	44	2-320575-2	—	1 & 2	5/16
	45	2-320564-1	—	1 & 2	3/8
46	2-328976-1	—	1 & 2	1/2	

Military Approvals

Class 1 and Class 2 Military Approvals (Continued)

**Military Specifications
M7928/1**

(Continued)

AWG	M7928/1 Dash Numbers	PIDG-Insulation Restricting		Class	Stud Size
		Part Numbers			
		Loose Piece	Tape Mounted		
14	47	52274-1	—	1 & 2	4
	48	2-320561-4	—	1 & 2	6
	49	51864-8	—	1 & 2	6
	50	1-51864-1	—	1 & 2	8
		—	1-51864-7	2	8
	51	51864-9	—	1 & 2	10
		—	1-51864-5	2	10
	52	2-320563-4	—	1 & 2	1/4
	53	2-320575-3	—	1 & 2	5/16
	54	2-320564-2	—	1 & 2	3/8
55	2-328976-2	—	1 & 2	1/2	
12	56	2-36161-5	—	1 & 2	6
	57	2-320568-2	—	1 & 2	8
	58	2-36161-3	—	1 & 2	10
	59	2-320569-5	—	1 & 2	1/4
	60	2-320576-2	—	1 & 2	5/16
	61	2-320577-1	—	1 & 2	3/8
	62	52077-1	—	2	1/2
	63	2-36161-6	—	1 & 2	6
10	64	2-320568-3	—	1 & 2	8
	65	2-36161-4	—	1 & 2	10
		—	2-36161-8	2	10
	66	2-320569-6	—	1 & 2	1/4
	—	2-320569-8	2	1/4	
	67	2-320576-3	—	1 & 2	5/16
	68	2-320577-2	—	1 & 2	3/8
69	52077-2	—	2	1/2	

**Military Specifications
M7928/4**

AWG	M7928/4 Dash Numbers	PIDG PVF ₂		Class	Stud Size
		Part Numbers			
		Loose Piece	Tape Mounted		
22-18	101	53406-1	—	1 & 2	6
	102	53407-1	—	1 & 2	6
		—	53407-2	2	6
	103	53409-1	—	1 & 2	10
	104	53411-1	—	1 & 2	5/16
105	53412-1	—	1 & 2	3/8	
16-14	106	53415-1	—	1 & 2	6
	107	53416-1	—	1 & 2	6
		—	53416-2	2	6
	108	53418-1	—	1 & 2	10
12-10	—	53418-2	2	10	
	109	53420-1	—	1 & 2	5/16
	110	53421-1	—	1 & 2	3/8
	111	53423-1	—	1 & 2	6
		53425-1	—	1 & 2	10
26-24	—	53425-2	2	10	
	112	53427-1	—	1 & 2	5/16
	113	53428-1	—	1 & 2	3/8
	114	53428-1	—	1 & 2	3/8
26-24	143	53400-1	—	1 & 2	2
	144	53401-1	—	1 & 2	4
	145	53402-1	—	1 & 2	6
	146	53403-1	—	1 & 2	8
	147	53404-1	—	1 & 2	10

Military Approvals

Class 1 and Class 2 Military Approvals (Continued)

**Military Specifications
M7928/4**

(Continued)

AWG	M7928/4 Dash Numbers	PIDG PVF ₂		Class	Stud Size
		Part Numbers			
		Loose Piece	Tape Mounted		
22-18	148	53405-1	—	1 & 2	4
		53408-1	—	1 & 2	8
	149	—	53408-2	2	8
		53410-1	—	1 & 2	1/4
		—	53410-2	2	1/4
16-14	151	53413-1	—	1 & 2	1/2
	152	53414-1	—	1 & 2	4
	153	53417-1	—	1 & 2	8
	154	53419-1	—	1 & 2	1/4
	155	53422-1	—	1 & 2	1/2
12-10	156	53424-1	—	1 & 2	8
		—	53424-2	2	8
	157	53426-1	—	1 & 2	1/4
	158	53429-1	—	2	1/2

**Military Specifications
M7928/5**

AWG	M7928/5 Dash Numbers	PIDG Window Splice		Class
		Part Numbers		
		Loose Piece	Tape Mounted	
26-24	1	323994	—	1 & 2
24-20	2	323975	—	1 & 2
		—	2-323975-3	2
22-18	3	320559	—	1 & 2
		—	2-320559-4	2
16-14	4	320562	—	1 & 2
		—	2-320562-3	2
12-10	5	320570	—	1 & 2

**Military Specifications
M7928/6**

AWG	M7928/6 Dash Numbers	PIDG Window Splice PVF ₂		Class
		Part Numbers		
		Loose Piece	Tape Mounted	
26-24	1	53546-1	—	1 & 2
24-20	2	53547-1	—	1 & 2
		—	53547-2	2
22-16	3	53548-1	—	1 & 2
		—	53548-2	2
16-14	4	53549-1	—	1 & 2

Military Approvals

Class 1 and Class 2 Military Approvals (Continued)

**Military Specifications
MS 17143**

AWG	MS17143 Dash Numbers	PIDG		Class	Stud Size
		Part Numbers			
		Loose Piece	Tape Mounted		
22-18	1	327932	—	1 & 2	8
16-14	2	2-327934-2	—	1 & 2	8
12-10	3	327936	—	1 & 2	8
22-18	4	2-327938-1	—	1 & 2	6
		—	2-327938-2	2	6
16-14	5	2-327940-4	—	1 & 2	6
12-10	6	327942	—	1 & 2	6
22-18	7	327944	—	1 & 2	8
		—	2-327944-2	2	8
16-14	8	2-327946-4	—	1 & 2	8
12-10	9	327948	—	1 & 2	8
22-18	10	2-327950-1	—	1 & 2	5
16-14	11	2-327952-2	—	1 & 2	5
		—	2-327952-6	2	5
12-10	12	327954	—	1 & 2	5
		—	2-327954-2	2	5
22-18	13	2-327956-1	—	1 & 2	6
16-14	14	2-327958-4	—	1 & 2	6
12-10	15	2-327960-1	—	1 & 2	6
		—	2-327960-2	2	6
22-18	16	327962	—	1 & 2	4
16-14	17	2-327964-4	—	1 & 2	4
12-10	18	327966	—	1 & 2	4
22-18	19	2-327968-1	—	1 & 2	4
16-14	20	2-327970-4	—	1 & 2	4
12-10	21	327972	—	1 & 2	4

Tooling

Insulated Terminals and Splices — 30 to 10 AWG Wire Range

Description	AMP Wire Range	Tools for Loose Piece Termination				Tools for Tape Mounted Terminations				
		Hand Tools		Pneumatic Tools		Tape Dies for 69875 AMP-TAPETRONIC No Applicator Required	Tape Dies for 354500-1 AMP-O-LECTRIC Model "G" Applicator 567200-3	Tape Dies for 818380-1 AUTO-PRO Applicator 818057-2	Tape Dies for AMPOMATOR CLS III G, CLS IV AMP-O-LECTRIC Applicator 687658-1	Tape Dies for 565435-5 AMP-O-LECTRIC Model "K" Applicator 567200-2
		Single Wire Range	Multi-Wire Range	Heads for 6-26 Single Wire Range	Heads for 6-26 Multi-Wire Range					
PIDG Terminals & Splices and PLASTI-GRIP Terminals	30-26	69163—uses 26-22 Terms.	—	—	—	—	—	—	—	—
	26-22	46121 ¹	59275 ¹	314537-1	—	69344	69877	69877	69877	69877
	22-16	47386 [†]	59250 [†] 59824-1 58433-3 ²	314270-3	679305-1	47806-2	69872* 59826-1 ¹	69872* 59826-1 ¹	69872* 59826-1 ¹	69872* 59826-1 ¹
	16-14	68343-1 (.250 exp.) 47387	59250 [†] 59824-1 ¹ 58433-3 ²	314269-1	679305-1	47807-1	69873* 59827-1 ¹	69873* 59827-1 ¹	69873* 59827-1 ¹	69873* 59827-1 ¹
	12-10 16-14 HD	59239-4 [†] 59287-2 (.300 exp.)	59824-1 ¹ 58433-3 ²	679300-1	679305-1	47808-6 Std. 47808-5 (.300 exp.)	69874* 69897 (.300 exp.) 59828-1 ¹	69874* 69897 (.300 exp.) 59828-1 ¹	69874* 69897 (.300 exp.) 59828-1 ¹	69874* 69897 (.300 exp.) 59828-1 ¹
PLASTI-GRIP Splices	26-22	46121 (butt spl. only)	—	—	—	—	—	—	—	—
	22-16	45160 (butt spl. only) 45449 (parallel spl. only)	58433-3 ² (butt spl. only)	314868-1 (butt spl. only)	—	—	69872 (butt spl. only)	69872 (butt spl. only)	69872 (butt spl. only)	69872 (butt spl. only)
	16-14	45575-1 (butt spl. only) 45450 (parallel spl. only)	58433-3 ² (butt spl. only)	314869-1 (butt spl. only)	—	—	69873 (butt spl. only)	69873 (butt spl. only)	69873 (butt spl. only)	69873 (butt spl. only)
	12-10 16-14 HD	59489 (butt spl. only) 59287-1 (.300 exp. butt spl. only) 59270 (parallel spl. only)	58433-3 ² (butt spl. only)	—	—	—	69874 (butt spl. only)	69874 (butt spl. only)	69874 (butt spl. only)	69874 (butt spl. only)

¹Tooling with adjustable insulation crimp.

*Same die set/configuration as in hand tools.

[†]TETRA-CRIMP die configuration.

²PRO-CRIMPER II commercial tool not approved for UL applications.

³69710-1 hand tool.

⁴6-26 Pneumatic Tool Adapter

Tooling (Continued)

Insulated Terminals and Splices – 8 to 4/0 AWG Wire Range

Description	Wire Size	Tools for Loose Piece Terminations				Tools for Tape Mounted Terminations	
		Hand Tools	Dies for Crimp Head 69051 ¹ & Hydraulic Hand Tool 59974-1	Dies for Crimp Head 69066 ¹ & 58422-1 ¹	Head for Pneumatic Hand Tool 69015	Dies for AMP-TAPETRONIC Machine 68250-1	Dies for AMP-TAPETRONIC Machine with Insulation Adjustment 68250-2
PLASTI-GRIP Terminals and Splices	8	69959	48752-1 47820 ²	—	—	68247-1 ²	1214512-1 ³ 1214512-2 ⁴
	6	—	48753-1 47821 ²	—	68325-1	68248-1 ²	1213500-1 ³ 1213500-2 ⁴
	4	—	48754-1 47822 ²	—	—	68249-1 ²	1213098-1 ³ 1213098-2 ⁴
	2	—	48755-1 47823 ²	—	—	—	—
	1/0	—	—	48756-1	—	—	—
	2/0	—	—	48757-1	—	—	—
TERMINYL Terminals and Splices	8	—	47820	—	68285-1	—	—
	6	—	47821	—	—	—	—
	4	—	47822	—	—	—	—
	2	—	47823	—	—	—	—
	1/0	—	—	47824	—	—	—
	2/0	—	—	47825	—	—	—
	3/0	—	—	47915	—	—	—
	4/0	—	—	47918	—	—	—
4 HD	—	—	69463	—	—	—	

¹Heads for Power Units 69120-1, 69120-2, or 314979-1.

²No insulation crimp.

³Without insulation crimp.

⁴With insulation crimp.

Insulated FASTON Terminals and Splices— 26 to 10 AWG Wire Range

Wire Size	Hand Tool	Tools for Tape Mounted Terminations			Tools for Strip Form Terminations
		Tape Dies for 69875 AMP-TAPETRONIC No Applicator Required	Tape Dies for AMP-O-LECTRIC ¹ Model "G" Applicator 567200-3	Tape Dies for AMPOMATOR CLS III G, CLS IV Applicator 687658-1	AMPOMATOR CLS III G, CLS IV Applicators
26-24	48518-2	69877-2	69877-2	69877-2	—
22-18	59824-1	59826-1	59826-1*	59826-1	466788-3 ²
22-18 (Natural)	90185-1	90248-2	90248-2	90248-2	466554-3
16-14	59824-1	59827-1	59827-1*	59827-1	466789-3 ²
14-12	90246-1	90240-2	90240-2	90240-2	—
12-10	59824-1	59828-1	59828-1*	59828-1	466790-4 ²

*Only UL and CSA approved.

¹AMP-O-LECTRIC Model "K" 565435-5 uses applicator 567200-2.

²Die included with applicator.

Tooling (Continued)

Loose Form Terminal and Splice Tooling

CERTI-CRIMP Hand Tools



Double Action Hand Tool



Heavy Head Hand Tool



“C” Head Straight Action Hand Tool
Part No. 69710-1



PRO-CRIMPER II Hand Tool
Part No. 58433-3



T-HEAD Tool
Part No. 59250, 59275

TETRA-CRIMP Hand Tool



Part No. 59824-1

Hydraulic Hand Tools



Part No. 59974-1 (Dies Required)

Tooling (Continued)

Pneumatic Tools



Part No. 69015



**Part No. 69365 (Hand Actuation)
Part No. 69365-2 (Foot Actuation)**

Crimping Heads



Part No. 58422-1
(408-9535)



Part No. 69066
(408-2453)



Part No. 69051

6-26 Tool



Tooling (Continued)

Tape Mounted

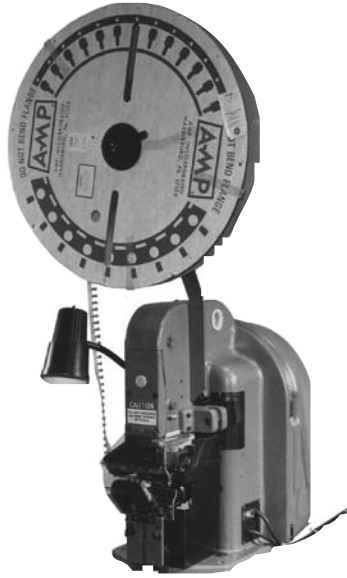

**AMP-TAPETRONIC Machine
69875, 68250-1
(Requires Dies)**



**AMP-O-LECTRIC, Model "G" Machine
(Requires Applicator and Dies)**

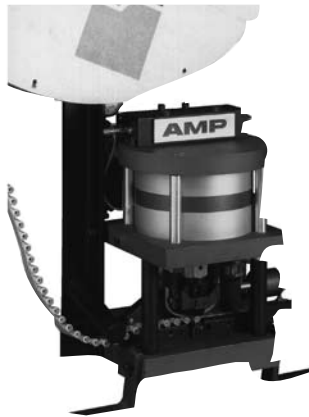

**AUTO-PRO Machine 818380-1
(Requires Applicator and Dies)**



**AMPOMATOR CLS IV Machine
217500-1
(Requires Applicator and Dies)**

Part Number Index

Note: This index lists all cataloged parts by base no. only. Complete part nos. (with prefixes and/or suffixes) are shown on the page(s) indicated.

Part No.	Page
31880	9
31884	14
31885	14
31886	9
31887	9
31888	14
31890	9
31891	14
31894	10
31895	10
31897	10
31903	14
32050	21
32051	21
32053	21
32054	21
32056	22
32057	22
32058	22
32059	22
32060	22
32403	21
32404	21
32446	32
32448	32
32456	26
32497	23
32498	23
32510	23
32561	23
32562	23
32588	22
32589	22
32835	9
32836	9
32837	9
32883	12
32944	38
32945	38
32947	38
32948	38
32949	38
32950	38
32951	38
32952	38
32953	38
32957	39
32958	39
32959	39
32960	39
32961	39
32981	44
33155	23
33156	23
33168	20
33172	20
33173	20
33476	19
33643	14
33724	11

Part No.	Page
33734	11
34067	50
34068	50
34069	50
34070	50
34071	50
34072	50
34073	52
34080	21
34090	48
34131	51
34132	51
34133	51
34134	51
34135	51
34136	51
34140	38
34141	38
34142	38
34143	38
34144	38
34145	38
34146	38
34147	38
34148	38
34149	38
34150	38
34151	39
34152	39
34155	44
34156	44
34157	39
34158	39
34159	39
34160	39
34161	39
34162	39
34163	39
34164	39
34165	44
34166	44
34167	44
34168	40
34169	40
34170	40
34171	40
34172	40
34173	40
34176	44
34178	51
34203	50
34204	50
34205	50
34207	51
34243	50
34294	30
34313	26
34406	26
34512	20
34541	21
34805	11
34806	11
34810	11
34821	39
34822	39

Part No.	Page
34823	39
34824	40
34825	40
34826	40
34827	40
34835	40
34837	40
34852	40
34853	40
34854	40
34855	40
34856	40
34898	43
34945	50
34954	39
34959	39
34974	11
35106	11
35107	12
35108	12
35109	12
35110	12
35111	13
35112	13
35148	12
35149	12
35150	13
35151	13
35152	22
35216	26
35229	9
35244	50
35273	12
35274	11
35279	20
35316	12
35345	14
35346	14
35349	40
35362	14
35363	14
35364	14
35440	26
35449	38
35451	38
35478	14
35481	26
35492	40
35538	14
35559	22
35604	14
35605	14
35634	11
35762	32
35787	12
36149	9, 15, 16
36150	9
36151	9
36152	9
36153	9, 15, 16
36154	9
36157	10
36158	10
36160	11
36161	12, 17

Part No.	Page
36203	12
36254	9
36485	14
36954	26
42844	34
50534	8
50881	10
51861	14
51863	9, 15, 16
51864	10, 11, 16, 17
51874	23
52041	41
52042	41
52043	42
52044	42
52045	42
52046	42
52077	13, 17
52124	8
52189	8
52262	41
52263	41
52264	41
52265	41
52266	42
52267	42
52273	15, 16
52274	16, 17
52283	28
52284	28
52289	42
52291	41
52307	15, 16
52350	41
52369	23
52403	25
52408	25
52409	25
52410	25
52411	25
52420	25
52421	25
52422	25
52423	25
52430	25
52431	25
52432	25
52433	25
52453	47
52454	47
52455	47
52463	47
52464	47
52465	47
52474	47
52475	47
52856	45
52921	24
52922	24
52923	24
52924	24
52925	24
52927	24
52928	24
52929	24

Part Number Index (Continued)

Part No.	Page	Part No.	Page	Part No.	Page	Part No.	Page
52930	24	54754	43	320571	10, 15, 16	323914	8, 15
52931	24	54771	27	320572	10, 15, 16	323915	8
52933	24	54773	27	320573	10, 15, 16	323916	8, 15
52934	24	54774	49	320574	11	323975	31
52935	24	54775	49	320575	11, 16, 17	323985	8
52936	24	55137	52	320576	13, 17	323986	8
52937	24	55148	18	320577	13, 17	323989	8
52939	24	55157	14	320619	10	323990	8
52940	24	55319	35	320620	32	323994	31
52941	24	55621	41	320627	11	324011	27
52942	24	55629	50	320629	19	324015	23
52943	24	55654	43	320630	11	324043	54, 60
52945	24	55675	34	320631	11	324044	54, 60
52947	46	55678	40	320634	12	324045	54, 60
52948	46	55679	41	320665	44	324046	54, 60
52949	46	55680	42	320773	9	324047	54, 60
52950	46	55685	58	320861	23	324048	54, 60
52951	46	55694	19	320862	23	324049	54, 60
52955	46	55768	24	320863	23	324050	54, 60
52956	46	55777	19	320882	9	324051	54, 60
52957	46	55785	50	321013	8	324052	54, 60
52961	47	55792	50	321026	50	324053	54, 60
52962	47	55793	50	321035	21	324054	54, 60
52963	47	55822	55	321045	11	324055	54, 60
53041	54	55936	10	321206	19	324056	55, 60
53049	15	60544	34	321233	22	324057	55, 60
53050	15	60893	35	321235	36	324058	55, 60
53051	15	60894	35	321283	20	324075	8
53052	15	61048	35	321286	50	324082	54
53053	15	61059	35	321518	39	324083	55, 60
53054	15	61060	35	321522	10	324084	55, 60
53055	15	61198	34	321611	26	324085	55, 60
53056	15	61678	35	321617	8	324086	11
53057	15	150247	10	321620	8	324111	54
53073	8	165167	52	321688	36	324112	54
53078	15	165429	29	321808	26	324113	61
53115	21	184234	35	322001	21	324114	54
53119	54	184235	35	322238	14	324123	10
53222	29	184261	34	322249	45	324138	50
53240	46	184262	34	322307	49	324158	9
53241	46	184264	34	322310	49	324159	10
53242	46	184265	34	322312	49	324165	45
53244	46	184267	35	322313	49	324169	45
53245	46	184268	35	322315	49	324170	45
53246	47	320209	19	322316	49	324172	45
53247	47	320263	48	322395	49	324184	48
53248	47	320306	26	322426	23	324185	55, 60
53546	31	320381	26	322724	12	324187	55, 60
53547	31	320551	9, 15, 16	322777	23	324188	55, 60
53548	31	320552	9	322834	49	324225	29
53549	31	320553	9	322985	22	324227	51
53550	31	320554	9	322994	44	324228	51
53829	46	320555	32	323008	9	324533	11
53874	45	320559	31	323011	26	324543	30
53912	21	320560	10	323039	27	324544	58
53914	21	320561	10, 16, 17	323676	10	324548	58
53941	10	320562	31	323682	11	324549	58
53942	11	320563	11, 16, 17	323758	9	324557	23
54310	8	320564	11, 16, 17	323762	12	324560	45
54311	8	320565	10	323763	14	324567	23
54312	8	320566	32	323784	13	324577	23
54351	41	320567	12	323817	27	324581	45
54367	44	320568	12, 17	323818	27	324587	23
54725	43	320569	12, 17	323912	8	324597	23
54753	43	320570	31	323913	8	324603	20

Part Number Index (Continued)

Part No.	Page	Part No.	Page	Part No.	Page
324608	23	327964	19	640925	35
324615	13	327966	20	640927	35
324621	56	327968	19	640929	35
324622	56	327970	19	640931	35
324623	56	327972	20	641317	35
324625	56	328261	40	641320	34
324631	58	328281	22	641321	34
324657	56	328394	21	641324	35
324658	56	328427	50	696003	44
324659	56	328489	8	696006	44
324660	56	328516	45	696007	44
324662	56	328527	39	696010	50
324663	56	328569	56	696018	34
324915	12	328571	56	696020	18
324918	12	328655	54	696024	44
324987	58	328657	9	696025	50
324988	58	328849	11	696026	50
324989	58	328961	31	696047	40
324990	58	328975	10, 15, 16	696048	40
324993	10	328976	11, 16, 17	696076	26
325034	11	328996	10	696077	26
325148	19	328998	11	696108	35
325150	23	328999	11	696116	52
325197	22	329150	55		
325199	22	329389	12		
326741	44	329391	11		
326742	50	329636	8		
326819	38	329697	20		
326859	22	329951	8		
326861	21	330250	19		
326865	23	330518	40		
326875	8, 15	330648	9		
326876	21	330896	12		
326878	9	330966	54		
326882	10	331268	20		
326886	12	331366	23		
327043	44	331421	54		
327174	9	331453	26		
327583	31	331456	54		
327635	32	331467	13		
327636	32	350871	35		
327637	32	360025	36		
327638	31	360035	36		
327639	31	640174	34		
327654	9	640578	34		
327717	21	640902	34		
327735	44	640903	34		
327743	11	640904	34		
327748	30	640905	34		
327932	19	640906	34		
327934	20	640907	34		
327936	20	640908	34		
327938	19	640909	34		
327940	20	640910	34		
327942	20	640911	34		
327944	19	640913	34		
327946	20	640915	34		
327948	20	640916	34		
327950	19	640917	34		
327952	19	640918	35		
327954	20	640919	35		
327956	19	640921	35		
327958	20	640922	35		
327960	20	640923	35		
327962	19	640924	35		

Contact Us Worldwide

Americas

Argentina – Buenos Aires
Phone: +54-11-4733-2200
Fax: +54-11-4733-2211

Brasil – São Paulo
Phone: +55-11-2103-6000
Fax: +55-11-2103-6030

Chile – Santiago
Phone: +56-2-345-0361
Fax: +56-2-223-1477

Canada – Toronto
Phone: +905-475-6222
Fax: +905-474-5520
Product Information Center:
Phone: +905-470-4425
Fax: +905-474-5525

Colombia – Bogota
Phone: +57-1-319-8959
Fax: +57-1-319-8960

Mexico – Mexico City
Phone: +52-55-1106-0800
+01-800-733-8926
Fax: +52-55-1106-0901

For Latin/South American Countries not shown
Phone: +54-11-4733-2015
Fax: +54-11-4733-2083

United States
Harrisburg, PA
Phone: +1-717-564-0100
Fax: +1-717-986-7575
Product Information Center:
Phone: +1-800-522-6752
Fax: +1-717-986-7575
Troy, MI
Phone: +1-248-273-3359
Fax: +1-248-273-3322

Asia/Pacific

Australia – Sydney
Phone: +61-2-9554-2600
Fax: +61-2-9502-2556
Product Information Center:
Phone: +61-2-9840-8200
Fax: +61-2-9634-6188

India – Bangalore
Phone: +91-80-285-40800
Fax: +91-80-285-40820

Indonesia – Jakarta
Phone: +65-6482-0311
Fax: +65-6482-1012

Japan – Kawasaki, Kanagawa
Phone: +81-44-844-8111
Fax: +81-44-812-3207
Product Information Center:
Phone: +81-44-844-8013
Fax: +81-44-812-3200

Korea – Seoul
Phone: +82-2-3415-4500
Fax: +82-2-3486-3810

Malaysia – Selangor
Phone: +60-3-7805-3055
Fax: +60-3-7805-3066

New Zealand – Auckland
Phone: +64-9-634-4580
Fax: +64-9-634-4586

Philippines – Makati City
Phone: +632-848-0171
Fax: +632-867-8661

People's Republic of China
Hong Kong
Phone: +852-2735-1628
Fax: +852-2735-0243
Shanghai
Phone: +86-21-2407-1588
Fax: +86-21-2407-1599

Singapore – Singapore
Phone: +65-6482-0311
Fax: +65-6482-1012

Taiwan – Taipei
Phone: +886-2-8768-2788
Fax: +886-2-8768-2268

Thailand – Bangkok
Phone: +66-2-955-0500
Fax: +66-2-955-0505

Vietnam – Ho Chi Minh City
Phone: +84-8-930-5546
Fax: +84-8-930-3443

Europe/Middle East/Africa

Austria – Vienna
Phone: +43-1-905-60-0
Fax: +43-1-905-60-1333
Product Information Center:
Phone: +43-1-905-60-1249
Fax: +43-1-905-60-1251

Belarus – Minsk
Phone: +375 17 237 47 94
Fax: +375 17 237 47 94

Belgium – Kessel-Lo
Phone: +32-16-352-300
Fax: +32-16-352-352

Bulgaria – Sofia
Phone: +359-2-971-2152
Fax: +359-2-971-2153

Czech Republic and Slovakia
Czech Republic – Kurim
Phone: +420-541-162-111
Fax: +420-541-162-223
Product Information Center:
Phone: +420-541-162-113
Fax: +420-541-162-132

Denmark – Glostrup
Phone: +45-43-48-04-00
Fax: +45-43-44-14-14

Egypt – Cairo
Phone: +202-419-2334
Fax: +202-417-7647

Estonia – Tartu
Phone: +372-5138-274
Fax: +372-7400-779

Finland – Helsinki
Phone: +358-95-12-34-20
Fax: +358-95-12-34-250

France – Cergy-Pontoise Cedex
Phone: +33-1-3420-8888
Fax: +33-1-3420-8600
Product Information Center:
Phone: +33-1-3420-8686
Fax: +33-1-3420-8623

France Export Divisions –
Cergy-Pontoise Cedex
Phone: +33-1-3420-8804
Fax: +33-1-3420-8699

Germany – Bensheim
Phone: +49-6251-133-0
Fax: +49-6251-133-1600
Product Information Center:
Phone: +49-6251-133-1999
Fax: +49-6251-133-1988

Greece – Athens
Phone: +30-210-9370-396/397
Fax: +30-210-9370-655

Hungary – Budapest
Phone: +36-1-289-1000
Fax: +36-1-289-1010
Product Information Center:
Phone: +36-1-289-1016
Fax: +36-1-289-1017

Ireland – Dublin
Phone: +353-1-866-5612
Fax: +353-1-866-5714

Israel – Petach-Tikva
Phone: +972-3-929-0999
Fax: +972-3-919-1088

Italy – Collegno (Torino)
Phone: +39-011-4012-111
Fax: +39-011-4031-116
Product Information Center:
Phone: +39-011-4012-428
Fax: +39-011-40-287-428

Lithuania and Latvia
Lithuania – Vilnius
Phone: +370-5-213-1402
Fax: +370-5-213-1403
Product Information Center:
Phone: +370-5-211-3016
Fax: +370-5-213-1403

Netherlands – 's-Hertogenbosch
Phone: +31-73-6246-246
Fax: +31-73-6212-365
Product Information Center:
Phone: +31-73-6246-999
Fax: +31-73-6246-998

Norway – Nesbru
Phone: +47-66-77-88-50
Fax: +47-66-77-88-55

Poland – Warsaw
Phone: +48-22-4576-700
Fax: +48-22-4576-720
Product Information Center:
Phone: +48-22-4576-704
Fax: +48-22-4576-720

Romania – Bucharest
Phone: +40-21-311-3479/3596
Fax: +40-21-312-0574

Russia – Moscow
Phone: +7-495-790-7902
Fax: +7-495-721-1893
Product Information Center:
Phone: +7-495-790-7902-404
Fax: +7-495-790-7902-401

Russia – St. Petersburg
Phone: +7-812-718-8192
Fax: +7-812-718-8193

Slovenia – Ljubljana
Phone: +386-1561-3270
Fax: +386-1561-3240

South Africa – Port Elizabeth
Phone: +27-41-503-4500
Fax: +27-41-581-0440

Spain – Barcelona
Phone: +34-93-291-0330
Fax: +34-93-201-7879

Sweden – Upplands Väsby
Phone: +46-8-50-72-50-00
Fax: +46-8-50-72-50-01

Switzerland – Steinhilf
Phone: +41-71-447-0447
Fax: +41-71-447-0444

Turkey – Istanbul
Phone: +90-212-281-8181/2/3
+90-212-282-5130/5430
Fax: +90-212-281-8184

Ukraine – Kiev
Phone: +380-44-206-2265
Fax: +380-44-206-2264
Product Information Center:
Phone: +380-44-206-2265
Fax: +380-44-206-2264

United Kingdom –
Stanmore, Middlesex
Phone: +44-8706-080208
Fax: +44-208-954-6234
Product Information Center:
Freephone (UK only):
0800-267-666
Phone: +44-8706-080208
Fax: +44-208-420-8095

Engineering Notes



X-ON Electronics

Largest Supplier of Electrical and Electronic Components

Click to view similar products for [Terminals](#) category:

Click to view products by [TE Connectivity](#) manufacturer:

Other Similar products are found below :

[00-054007-01074-6](#) [00-054007-70206-1](#) [00-054007-70210-8](#) [00-054007-70217-7](#) [00-054007-70226-9](#) [00-054007-70228-3](#) [00-054007-70248-1](#) [00-054007-70256-6](#) [00-054007-70301-3](#) [00-054007-70316-7](#) [0-0320562-0](#) [00-054007-49560-4](#) [00-054007-70209-2](#) [00-054007-70225-2](#) [00-054007-70227-6](#) [00-054007-70231-3](#) [00-054007-70241-2](#) [00-054007-70242-9](#) [00-054007-70244-3](#) [00-054007-70246-7](#) [00-054007-70263-4](#) [00-054007-70288-7](#) [00-054007-70290-0](#) [00-054007-70300-6](#) [00-054007-70304-4](#) [01-2065-1-0216](#) [01-2900-1-04412](#) [00581P0075](#) [600TS-10](#) [60205-1](#) [604200-1](#) [605601-1](#) [60598-1-CUT-TAPE](#) [61314-6-C](#) [61810-3](#) [61-S](#) [61-SN](#) [626-0194](#) [62-NBM-A](#) [62-SN](#) [62-SP](#) [63-S](#) [640179-1](#) [M55155/059I03](#) [M55155/079C01](#) [M55155/099H02](#) [M55155/109H01](#) [M55155/109H02](#) [M55155/12XH05](#) [M55155/16XH02](#)