



FEATURES

- Excellent accuracy for both altimeter and diving applications until 60m depth
- Operating range: 0 to 7bar, -20 to +85 °C
- High resolution module: 0,4m air / 1mm water
- Fast conversion down to 1 ms
- Low power, 1 μ A (standby < 0.15 μ A)
- Integrated digital pressure sensor (24 bit $\Delta\Sigma$ ADC)
- Supply voltage 2.2 to 3.6 V
- I2C and SPI interface (Mode 0, 3)
- No external components (Internal oscillator)
- Excellent long term stability
- Hermetically sealable for outdoor devices
- High Endurance (HE version)

APPLICATIONS

- Dual mobile altimeter / depth meter systems
- Adventure or multi-mode watches
- Diving computer

MS5803-07BA

Altimeter and diving pressure sensor

The MS5803-07BA is a new digital, fully compensated pressure sensor with SPI and I²C bus interface. The MS5803-07BA HE is the high endurance pad technology version of the MS5803-07BA pressure sensor module. It is optimized for altimeter and in the same time water depth measurement with high resolution and accuracy. The sensor module includes a high linearity pressure sensor and an ultra-low power 24 bit $\Delta\Sigma$ ADC with internal factory calibrated coefficients. It provides a precise digital 24 Bit pressure and temperature value and different operation modes that allow the user to optimize for conversion speed and current consumption. A high resolution temperature output allows the implementation of a thermometer function without any additional sensor. The MS5803-07BA can be interfaced to virtually any microcontroller. The communication protocol is simple, without the need of programming internal registers in the device. The gel protection and antimagnetic stainless steel cap allows the use in 100m waterproof watches. This new sensor module generation is based on leading MEMS technology and latest benefits from TE proven experience and know-how in high volume manufacturing which have been widely used for over a decade.

TECHNICAL DATA

Sensor Performances ($V_{DD} = 3\text{ V}$)				
Pressure	Min	Typ	Max	Unit
Range	0		7	bar
ADC	24			bit
Resolution (1), Altimeter mode	0.04			mbar
Accuracy 0°C to +60°C, 400 to 1100 mbar (2)	-4.5		+4.5	mbar
Accuracy 0°C to +40°C, 400 to 7000 mbar	-50		+50	mbar
Response time (2)	0.5 / 1.1 / 2.1 / 4.1 / 8.22			ms
Long term stability		±1		mbar/yr
Temperature	Min	Typ	Max	Unit
Range	-20		+85	°C
Resolution		<0.01		°C
Accuracy	-3		+3	°C

Notes: (1) Oversampling Ratio: 4096
 (2) With auto-zero at one pressure point
 (3) Oversampling Ratio 4096 / 2048 / 1024 / 512 / 256

FUNCTIONAL BLOCK DIAGRAM

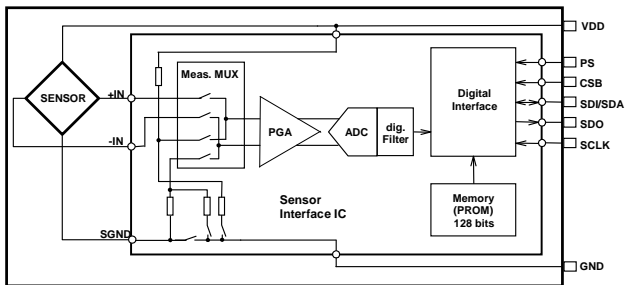

PERFORMANCE SPECIFICATIONS

ABSOLUTE MAXIMUM RATINGS

Parameter	Symbol	Conditions	Min.	Typ.	Max	Unit
Supply voltage	V _{DD}		-0.3		+3.6	V
Storage temperature ⁽³⁾	T _S		-40		+85	°C
Overpressure	P _{max}	ISO6425 ⁽¹⁾			30	bar
Maximum Soldering Temperature ⁽²⁾	T _{max}	40 sec max			250	°C
ESD rating		Human Body Model	-2		2	kV
Latch up		JEDEC standard No 78	-100		+100	mA

⁽¹⁾ The MS5807-07BA is qualified referring to the ISO 6425 standard and can withstand an absolute pressure of 30 bar in salt water.

⁽²⁾ Refer to application note 808

⁽³⁾ Storage in an environment of dry and non-corrosive gases

ELECTRICAL CHARACTERISTICS

Parameter	Symbol	Conditions	Min.	Typ.	Max	Unit
Operating Supply voltage	V _{DD}		2.2	3.0	+3.6	V
Operating Temperature	T		-20	+25	+85	°C
Output Word				24		bit
Supply current (1 sample per sec.)	I _{DD}	Depending on OSR	0.9		12.5	µA
Peak supply current		during conversion		1.4		mA
Standby supply current		at 25°C		0.02	0.14	µA
VDD Capacitor		From VDD to GND	100	470		nF

ANALOG DIGITAL CONVERTER (ADC)

Parameter	Symbol	Conditions	Min.	Typ.	Max	Unit	
Output Word				24		bit	
Conversion time ⁽⁴⁾	t _c	OSR	4096	7.40	8.22	9.04	ms
			2048	3.72	4.13	4.54	
			1024	1.88	2.08	2.28	
			512	0.95	1.06	1.17	
			256	0.48	0.54	0.60	

⁽⁴⁾ Maximum values must be used to determine waiting times in I2C communication

PERFORMANCE SPECIFICATIONS (CONTINUED)

PRESSURE OUTPUT CHARACTERISTICS (V_{DD} = 3 V, T = 25°C UNLESS OTHERWISE NOTED)

Parameter	Conditions		Min.	Typ.	Max	Unit
Operating Pressure Range	P _{range}	Full Accuracy	0		7	bar
Absolute Accuracy, autozero at one pressure point 400...1100 mbar ⁽¹⁾	0..60°C, 400..1100 mbar		-4.5		+4.5	mbar
Absolute Accuracy, autozero at one pressure point 400...7000 mbar ⁽¹⁾	0..40°C, 0..7000 mbar		-50		+50	mbar
Maximum error with supply voltage ⁽³⁾	V _{DD} = 2.2 V ... 3.6 V			±3		mbar
Long-term stability ⁽²⁾				±1		mbar/yr
Resolution RMS	OSR	4096		0.034		mbar
		2048		0.048		
		1024		0.067		
		512		0.097		
		256		0.176		

- (1) Wet/dry cycle: sensor must be dried typically once a day.
- (2) The long-term stability is measured with non-soldered devices.
- (3) With autozero at 3V point

TEMPERATURE OUTPUT CHARACTERISTICS (V_{DD} = 3 V, T = 25°C UNLESS OTHERWISE NOTED)

Parameter	Conditions		Min.	Typ.	Max	Unit
Absolute Accuracy 400 ...1100mbar	0..40°C		-1		+1	°C
Absolute Accuracy 400 ...1100mbar	-20..85°C		-2		+2	°C
Absolute Accuracy 400 ... 7000mbar	-20..85°C		-3		+3	°C
Maximum error with supply voltage ⁽⁴⁾	V _{DD} = 2.2 V ... 3.6 V			±0.2		°C
Resolution RMS	OSR	4096		0.002		°C
		2048		0.003		
		1024		0.005		
		512		0.008		
		256		0.012		

- (4) With autozero at 3V point

PERFORMANCE SPECIFICATIONS (CONTINUED)**DIGITAL INPUTS (PS, CSB, DIN, SCLK, SDA, SCL)**

Parameter	Symbol	Conditions	Min.	Typ.	Max	Unit
Serial data clock	SCLK	SPI protocol			20	MHz
Serial data clock	SCL	I2C protocol			400	kHz
Input high voltage	V _{IH}	Pins CSB	80% V _{DD}		100% V _{DD}	V
Input low voltage	V _{IL}		0% V _{DD}		20% V _{DD}	V
Input leakage current	I _{leak25°C}	at 25°C			0.15	μA

DIGITAL OUTPUTS (DOUT, SDA, SCL)

Parameter	Symbol	Conditions	Min.	Typ.	Max	Unit
Output high voltage	V _{OH}	I _{source} = 0.6 mA	80% V _{DD}		100% V _{DD}	V
Output low voltage	V _{OL}	I _{sink} = 0.6 mA	0% V _{DD}		20% V _{DD}	V
Load capacitance	C _{LOAD}			16		pF

PERFORMANCE CHARACTERISTICS

PRESSURE ERROR VS PRESSURE

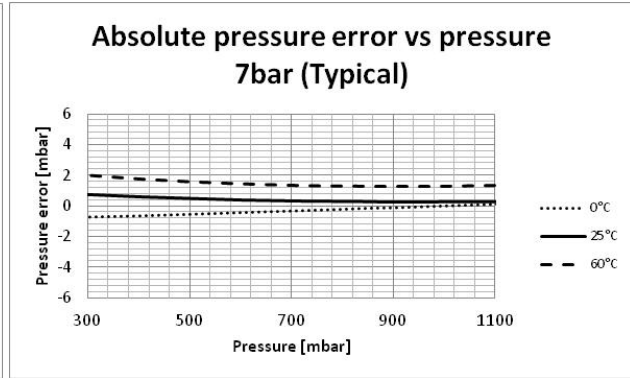
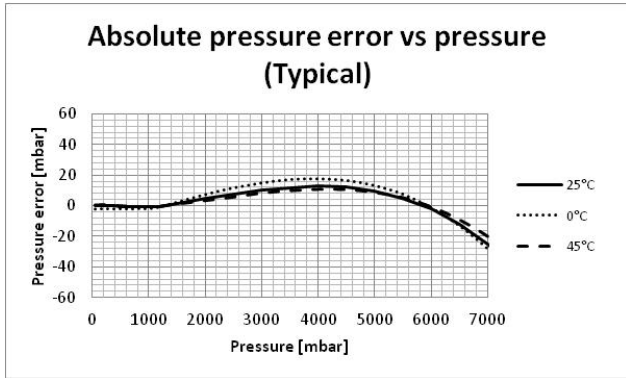

PRESSURE ERROR VS TEMPERATURE

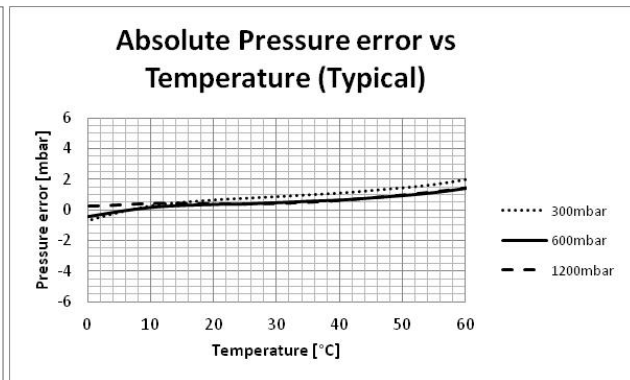
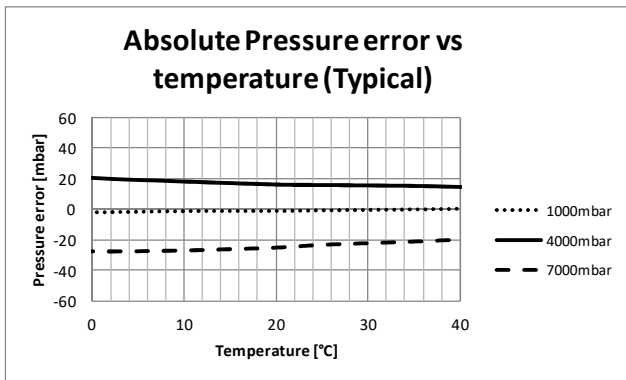

TEMPERATURE ERROR VS TEMPERATURE AND PRESSURE

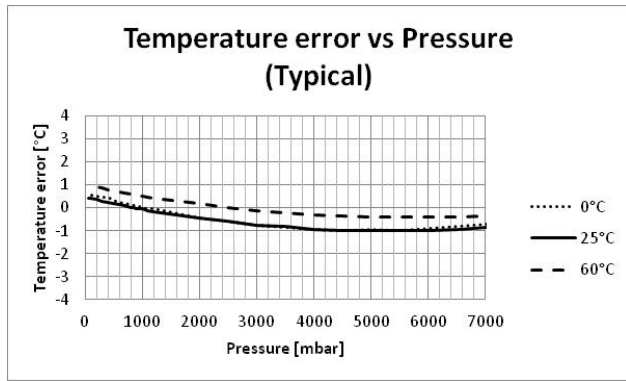
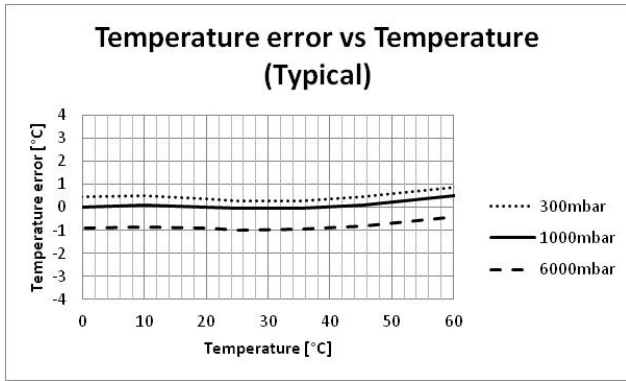

PRESSURE AND TEMPERATURE ERROR VS POWER SUPPLY

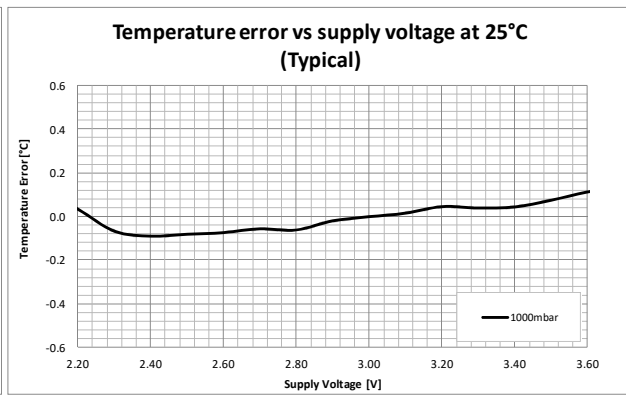
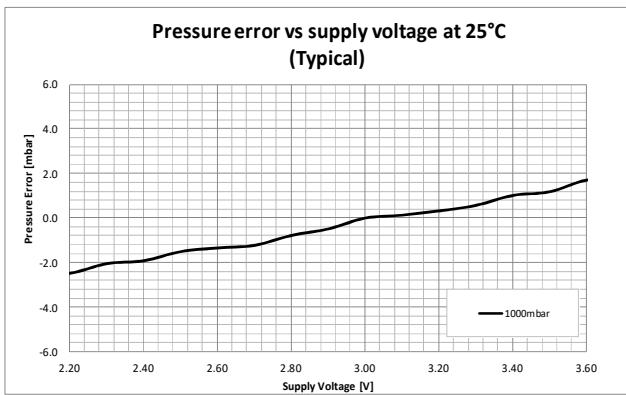

FUNCTIONAL DESCRIPTION

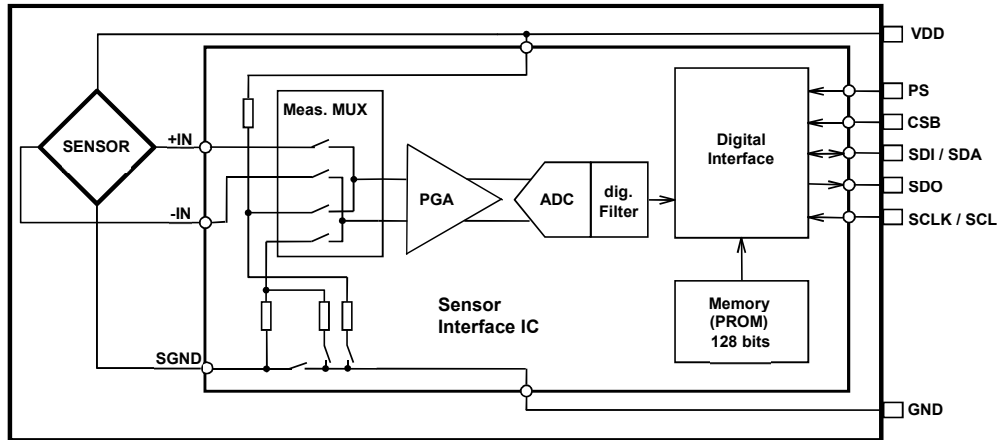

Figure 1: Block diagram of MS5803-07BA

GENERAL

The MS5803-07BA consists of a piezo-resistive sensor and a sensor interface IC. The main function of the MS5803-07BA is to convert the uncompensated analogue output voltage from the piezo-resistive pressure sensor to a 24-bit digital value, as well as providing a 24-bit digital value for the temperature of the sensor.

FACTORY CALIBRATION

Every module is individually factory calibrated at two temperatures and two pressures. As a result, 6 coefficients necessary to compensate for process variations and temperature variations are calculated and stored in the 128-bit PROM of each module. These bits (partitioned into 7 coefficients W1 to W7) must be read by the microcontroller software and used in the program converting D1 and D2 into compensated pressure and temperature values. The coefficient W0 is for factory configuration and W7 contains CRC and high pressure range compensation parameters.

SERIAL INTERFACE

The MS5803-07BA has built in two types of serial interfaces: SPI and I²C. Pulling the Protocol Select pin PS to low selects the SPI protocol, pulling PS to high activates the I²C bus protocol.

Pin PS	Mode	Pins used
High	I ² C	SDA, SCL, CSB
Low	SPI	SDI, SDO, SCLK, CSB

SPI MODE

The external microcontroller clocks in the data through the input SCLK (Serial CLock) and SDI (Serial Data In). In the SPI mode module can accept both mode 0 and mode 3 for the clock polarity and phase. The sensor responds on the output SDO (Serial Data Out). The pin CSB (Chip Select) is used to enable/disable the interface, so that other devices can talk on the same SPI bus. The CSB pin can be pulled high after the command is sent or after the end of the command execution (for example end of conversion). The best noise performance from the module is obtained when the SPI bus is quiet and without communication to other devices during the ADC conversion in progress.

I²C MODE

The external microcontroller clocks in the data through the input SCL (Serial CLock) and SDA (Serial DAta). The sensor responds on the same pin SDA which is bidirectional for the I²C bus interface. So this interface type uses only 2 signal lines and does not require a chip select, which can be favorable to reduce board space. In I²C-Mode the complement of the pin CSB (Chip Select) represents the LSB of the I²C address. It is possible to use two sensors with two different addresses on the I²C bus. The pin CSB shall be connected to VDD or GND (do not leave unconnected!).

Pin CSB	Address (7 bits)
High	0x76 (1110110 b)
Low	0x77 (1110111 b)

COMMANDS

The MS5803-07BA has only five basic commands:

1. Reset
2. Read PROM (128 bit of calibration words)
3. D1 conversion
4. D2 conversion
5. Read ADC result (24 bit pressure / temperature)

Size of each command is 1 byte (8 bits) as described in the table below. After ADC read commands the device will return 24 bit result and after the PROM read 16bit result. The address of the PROM is embedded inside of the PROM read command using the Ad2, Ad1 and Ad0 bits.

Bit number	Command byte								hex value
	0	1	2	3	4	5	6	7	
Bit name	PR M	COV	-	Typ	Ad2/ Os2	Ad1/ Os1	Ad0/ Os0	Stop	
Command									
Reset	0	0	0	1	1	1	1	0	0x1E
Convert D1 (OSR=256)	0	1	0	0	0	0	0	0	0x40
Convert D1 (OSR=512)	0	1	0	0	0	0	1	0	0x42
Convert D1 (OSR=1024)	0	1	0	0	0	1	0	0	0x44
Convert D1 (OSR=2048)	0	1	0	0	0	1	1	0	0x46
Convert D1 (OSR=4096)	0	1	0	0	1	0	0	0	0x48
Convert D2 (OSR=256)	0	1	0	1	0	0	0	0	0x50
Convert D2 (OSR=512)	0	1	0	1	0	0	1	0	0x52
Convert D2 (OSR=1024)	0	1	0	1	0	1	0	0	0x54
Convert D2 (OSR=2048)	0	1	0	1	0	1	1	0	0x56
Convert D2 (OSR=4096)	0	1	0	1	1	0	0	0	0x58
ADC Read	0	0	0	0	0	0	0	0	0x00
PROM Read	1	0	1	0	Ad2	Ad1	Ad0	0	0xA0 to 0xAE

Figure 2: Command structure

I²C INTERFACE

COMMANDS

Each I²C communication message starts with the start condition and it is ended with the stop condition. The MS5803-07BA address is 111011Cx, where C is the complementary value of the pin CSB. Since the IC does not have a microcontroller inside, the commands for I²C and SPI are quite similar.

RESET SEQUENCE

The reset can be sent at any time. In the event that there is not a successful power on reset this may be caused by the SDA being blocked by the module in the acknowledge state. The only way to get the MS5803-07BA to function is to send several SCLKs followed by a reset sequence or to repeat power on reset.

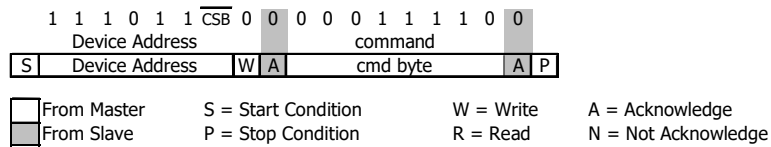

Figure 3: I²C Reset Command

CONVERSION SEQUENCE

A conversion can be started by sending the command to MS5803-07BA. When command is sent to the system it stays busy until conversion is done. When conversion is finished, the data can be accessed by sending a Read command, when an acknowledge appears from the MS5803-07BA, 24 SCLK cycles may be sent to receive all result bits. Every 8 bit the system waits for an acknowledge signal.

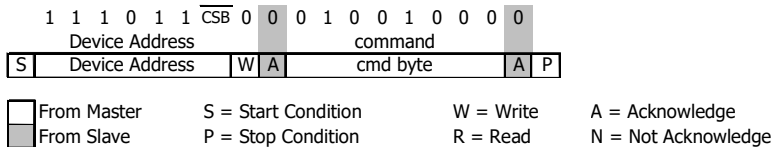

Figure 4: I²C Command to initiate a pressure conversion (OSR=4096, typ=D1)

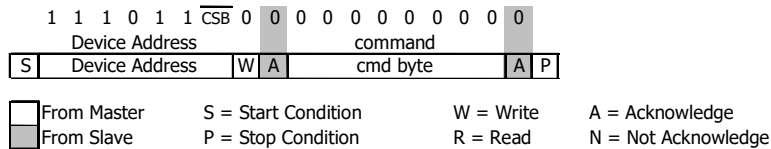

Figure 5: I²C ADC read sequence

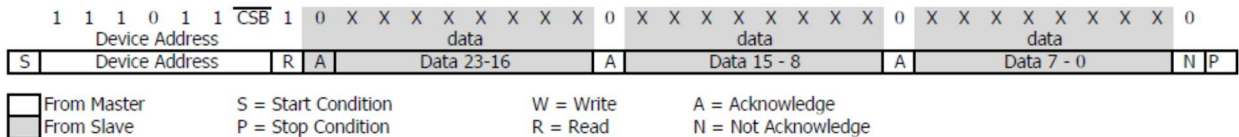

Figure 6: I²C pressure response (D1) on 24 bit from MS5803-07BA

PROM READ SEQUENCE

The PROM Read command consists of two parts. First command sets up the system into PROM read mode. The second part gets the data from the system.

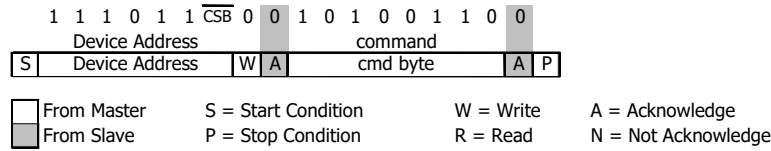

Figure 7: I²C Command to read memory address= 011 (Coefficient 3)

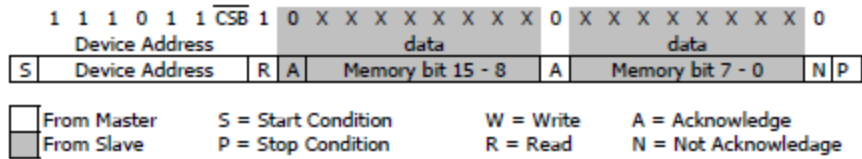

Figure 8: I²C answer from MS5803-07BA

SPI INTERFACE

RESET SEQUENCE

The Reset sequence shall be sent once after power-on to make sure that the calibration PROM gets loaded into the internal register. It can be also used to reset the device ROM from an unknown condition

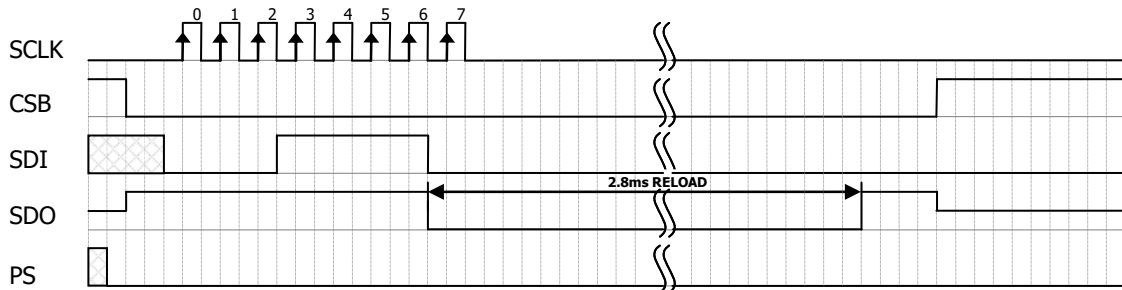

Figure 9: Reset command sequence SPI mode 0

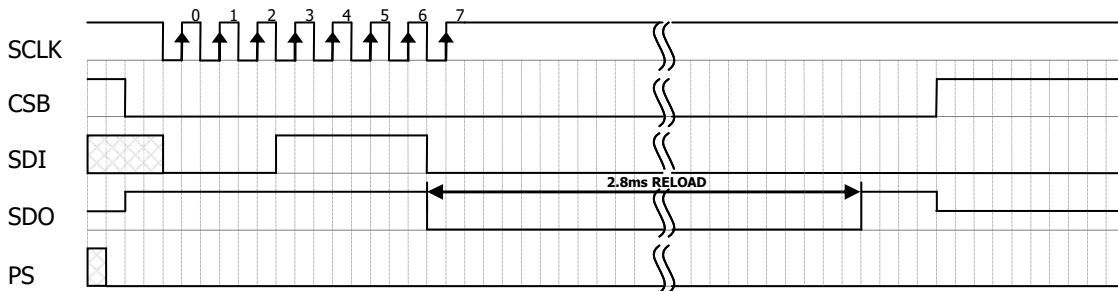

Figure 10: Reset command sequence SPI mode 3

CONVERSION SEQUENCE

The conversion command is used to initiate uncompensated pressure (D1) or uncompensated temperature (D2) conversion. The chip select can be disabled during this time to communicate with other devices.

After the conversion, using ADC read command the result is clocked out with the MSB first. If the conversion is not executed before the ADC read command, or the ADC read command is repeated, it will give 0 as the output result. If the ADC read command is sent during conversion the result will be 0, the conversion will not stop and the final result will be wrong. Conversion sequence sent during the already started conversion process will yield incorrect result as well.

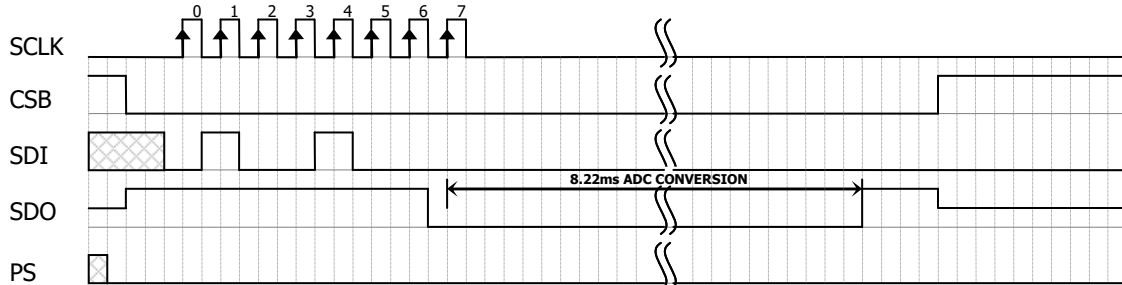

Figure 11: Conversion out sequence, Typ=d1, OSR = 4096

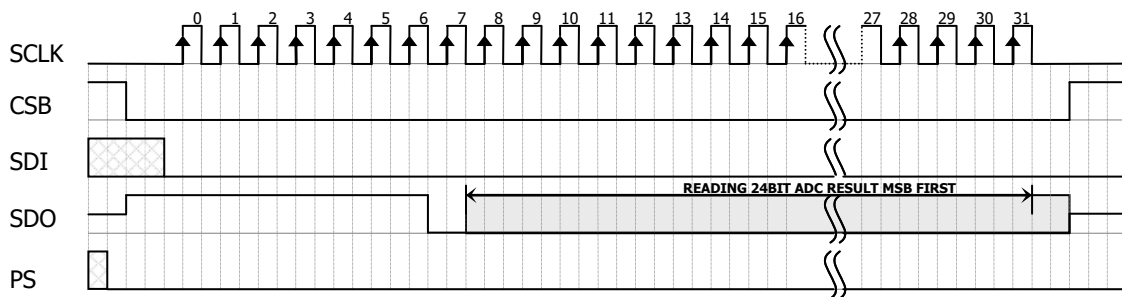

Figure 12: ADC Read sequence

PROM READ SEQUENCE

The read command for PROM shall be executed once after reset by the user to read the content of the calibration PROM and to calculate the calibration coefficients. There are in total 8 addresses resulting in a total memory of 128 bit. Address 0 contains factory data and the setup, addresses 1-6 calibration coefficients and address 7 contains the serial code and CRC. The command sequence is 8 bits long with a 16 bit result which is clocked with the MSB first.

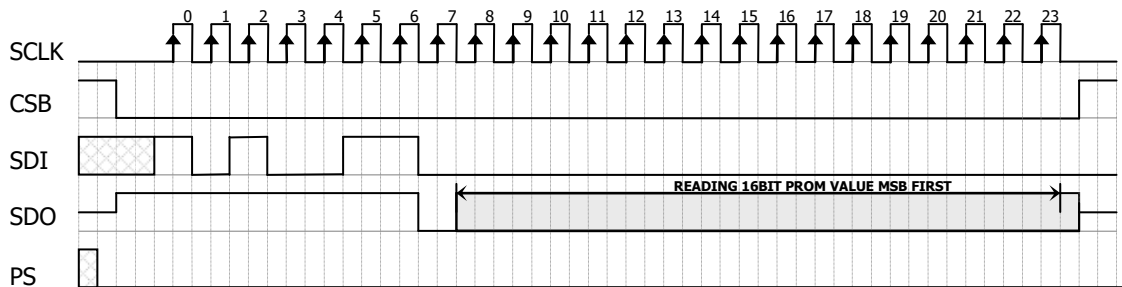

Figure 13: PROM Read sequence, address = 011 (Coefficient 3).

CYCLIC REDUNDANCY CHECK (CRC)

MS5803-07BA contains a PROM memory with 128-Bit. A 4-bit CRC has been implemented to check the data validity in memory.

A	D	D	D	D	D	D	D	D	D	D	D	D	D	D	D	D	D
d	B	B	B	B	B	B	B	B	B	B	B	B	B	B	B	B	B
d	5	4	3	2	1	0	9	8	7	6	5	4	3	2	1	0	
0	16 bit reserved for manufacturer																
1	C1 (16 bit unsigned)																
2	C2 (16 bit unsigned)																
3	C3 (16 bit unsigned)																
4	C4 (16 bit unsigned)																
5	C5 (16 bit unsigned)																
6	C6 (16 bit unsigned)																
7	C8 (6bits)					C7 (6bits)					CRC						

Figure 14: Memory PROM mapping

C Code example for CRC-4 calculation:

```

unsigned char crc4(unsigned int n_prom[])
{
    int cnt; // simple counter
    unsigned int n_rem=0; // crc reminder
    unsigned char n_bit;

    n_prom[7]=((n_prom[7]) & 0xFFF0); // CRC byte is replaced by 0
    for (cnt = 0; cnt < 16; cnt++) // operation is performed on bytes
    { // choose LSB or MSB
        if (cnt%2==1) n_rem ^= (unsigned short) ((n_prom[cnt]>>1]) & 0x00FF);
        else n_rem ^= (unsigned short) (n_prom[cnt]>>1)>>8);
        for (n_bit = 8; n_bit > 0; n_bit--)
        {
            if (n_rem & (0x8000)) n_rem = (n_rem << 1) ^ 0x3000;
            else n_rem = (n_rem << 1);
        }
    }
    n_rem= ((n_rem >> 12) & 0x000F); // final 4-bit reminder is CRC code
    return (n_rem ^ 0x00);
}
    
```

PRESSURE AND TEMPERATURE CALCULATION

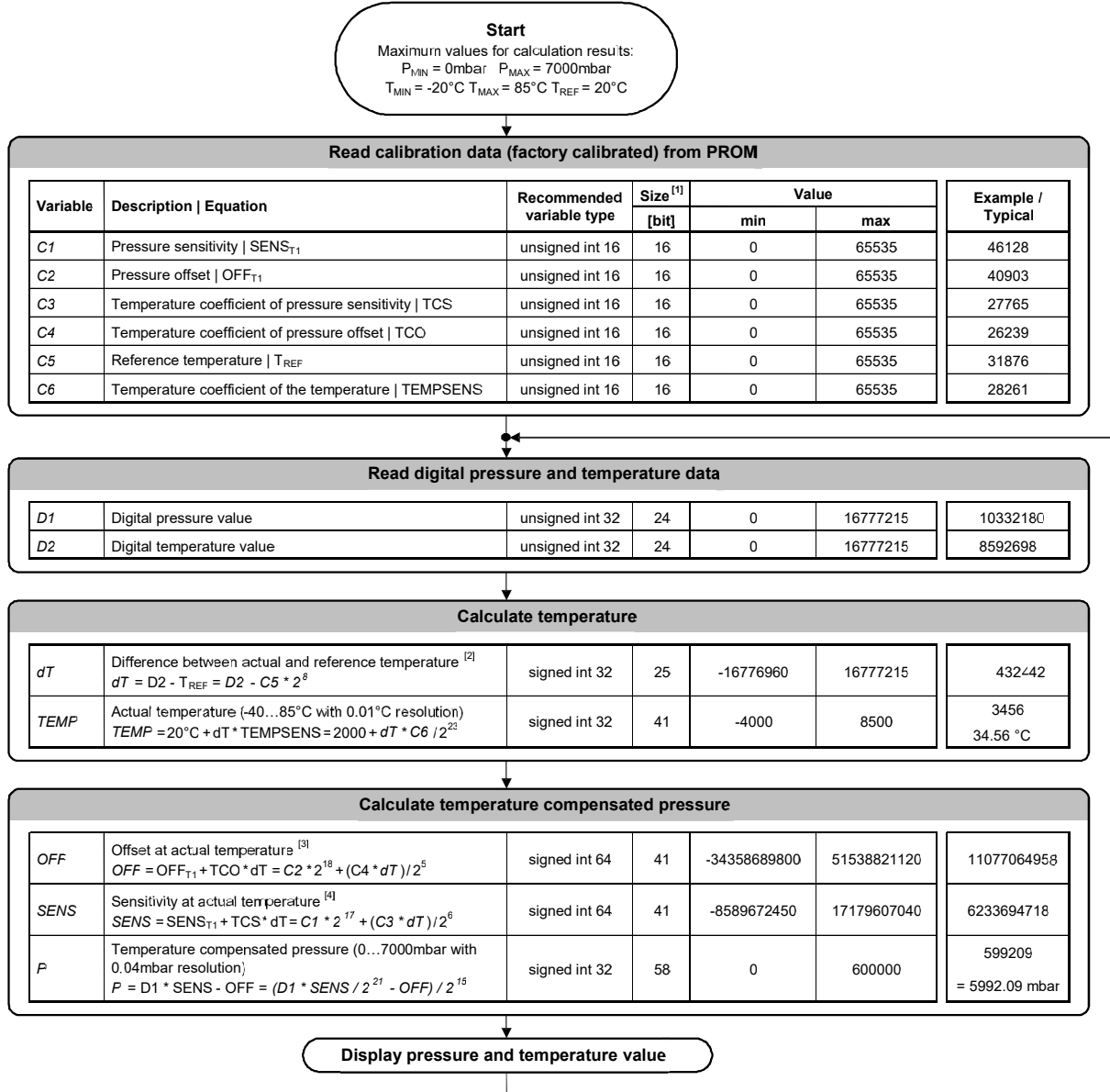

- Notes
- [1] Maximal size of intermediate result during evaluation of variable
 - [2] min and max have to be defined
 - [3] min and max have to be defined
 - [4] min and max have to be defined

Figure 15: Flow chart for pressure and temperature reading and software compensation.

SECOND ORDER TEMPERATURE COMPENSATION

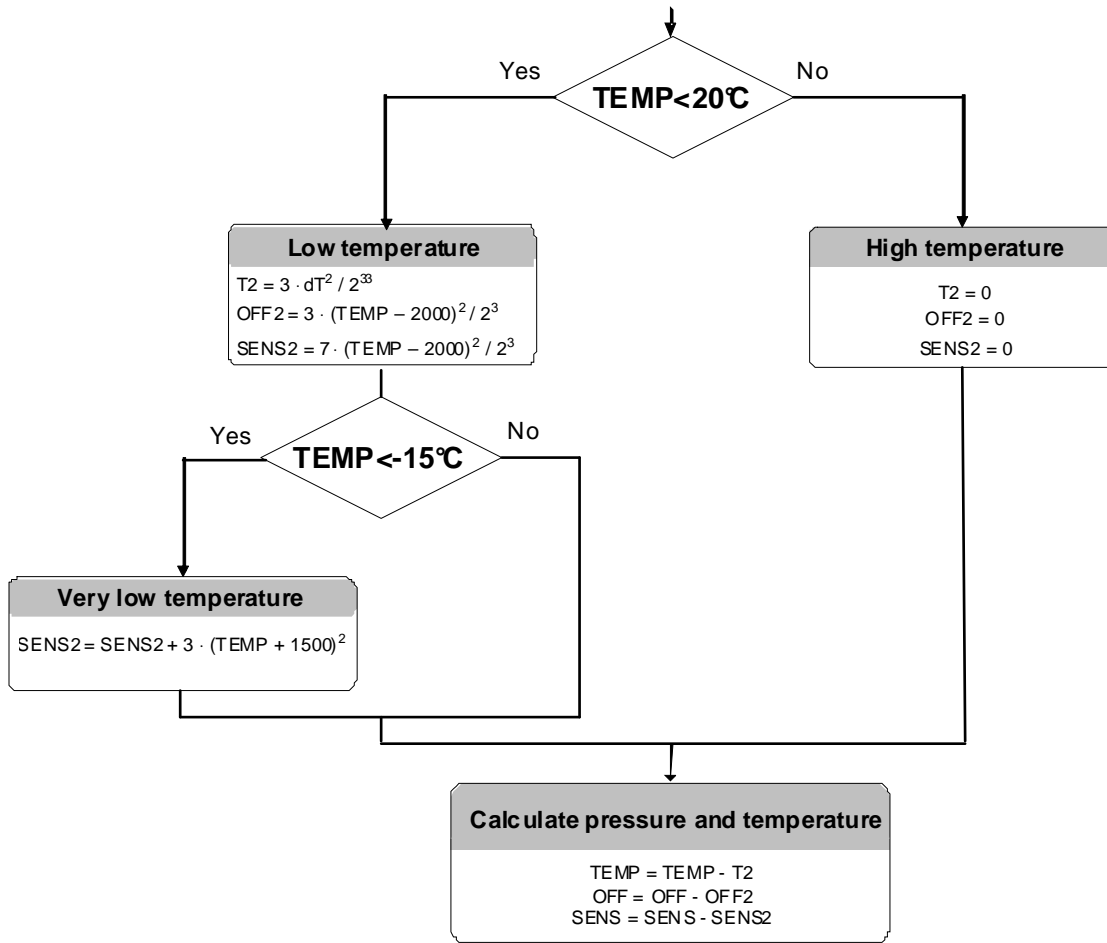

Figure 16: Flow chart for pressure and temperature to the optimum accuracy.

HIGH PRESSURE RANGE COMPENSATION

The last 16bits word of the PROM (Word7) is defined as follow:

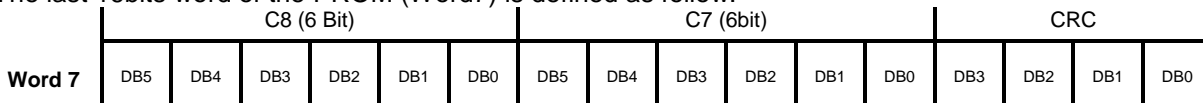

Figure 17: Word 7, bit description.

The first 4 bits (bit 0 to 3) of word 7 correspond to the checksum, the 6 following bits (bit 4 to 9) correspond to the C7 coefficient and the 6 last bits (bit 10 to 15) correspond to C8 coefficient.
When defining P and T as the pressure and temperature issued from the pressure and temperature calculation (p8), the compensated high pressure P3 is defined as follow:

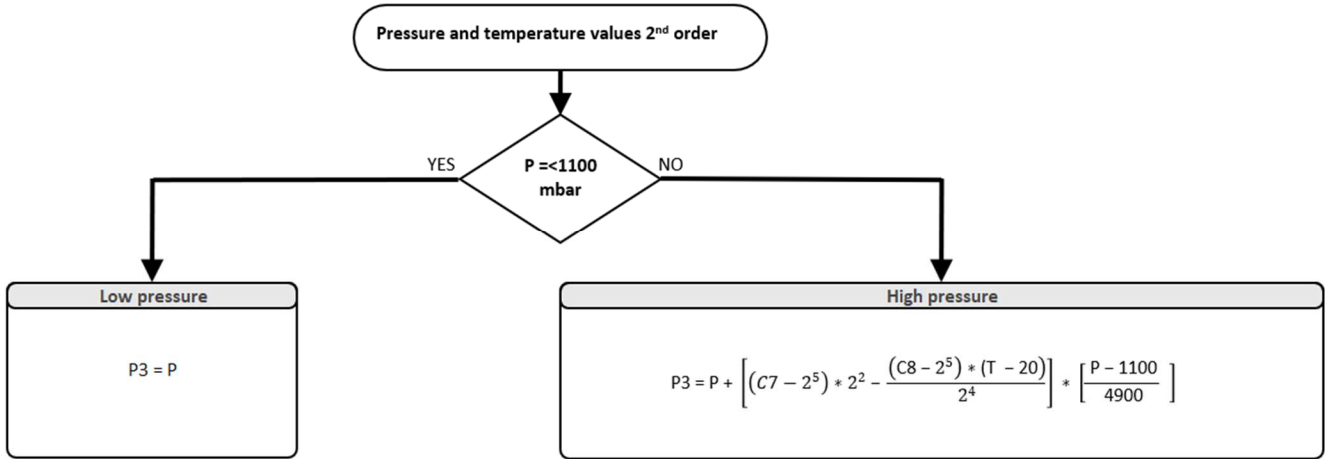

Figure 18: Flow chart for High pressure P3 calculation

APPLICATION CIRCUIT

The MS5803-07BA is a circuit that can be used in conjunction with a microcontroller in mobile altimeter applications. It is designed for low-voltage systems with a supply voltage of 3 V.

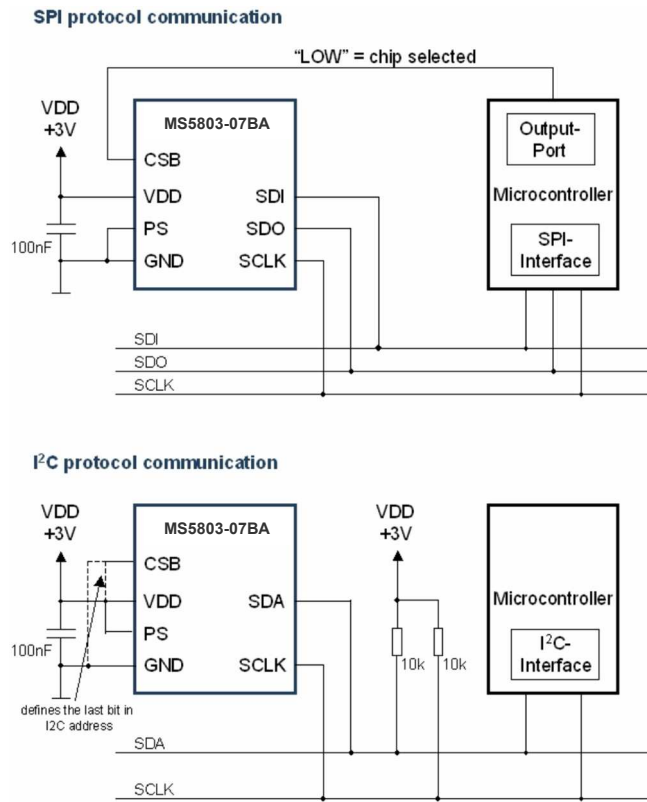

Figure 19: Typical application circuit with SPI / I²C protocol communication

MS5803-07BA

Altimeter and diving pressure sensor

PACKAGE OUTLINE AND PIN CONFIGURATION

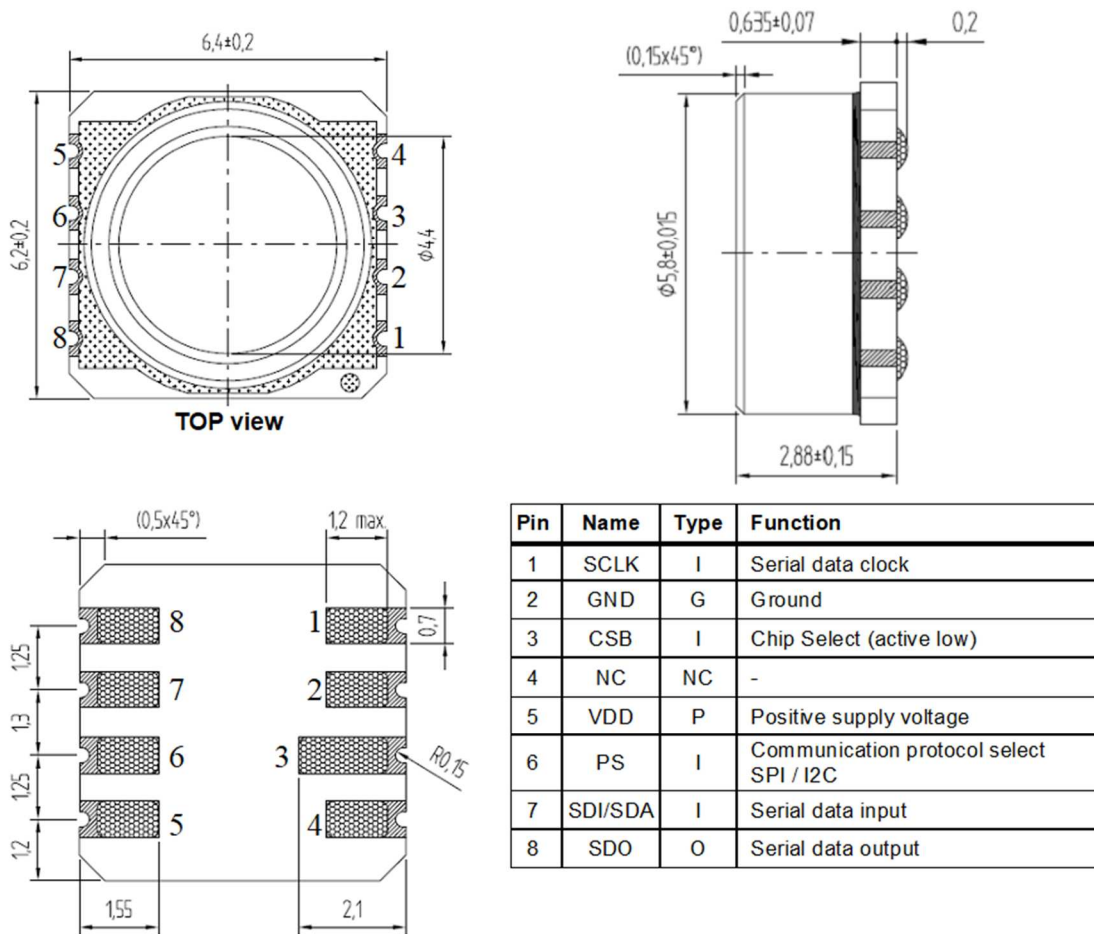

Figure 20: MS5803-07BA package outlines, pin configuration and description

- Notes:**
- (1) Dimensions in mm
 - (2) General tolerance ± 0.1
 - (3) Cap centering ± 0.15 from center of the ceramic

RECOMMENDED PAD LAYOUT

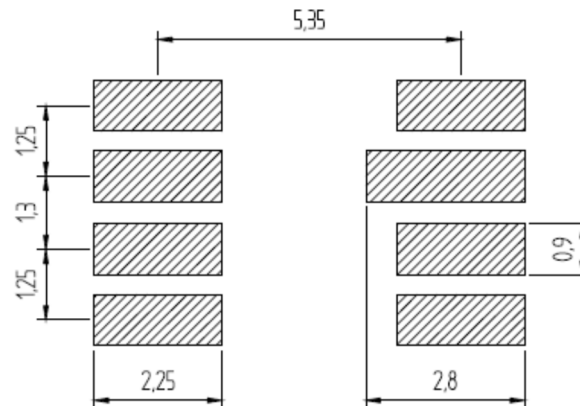

Figure 21: MS5803-07BA recommended pad layout

MS5803-07BA

Altimeter and diving pressure sensor

SHIPPING PACKAGE

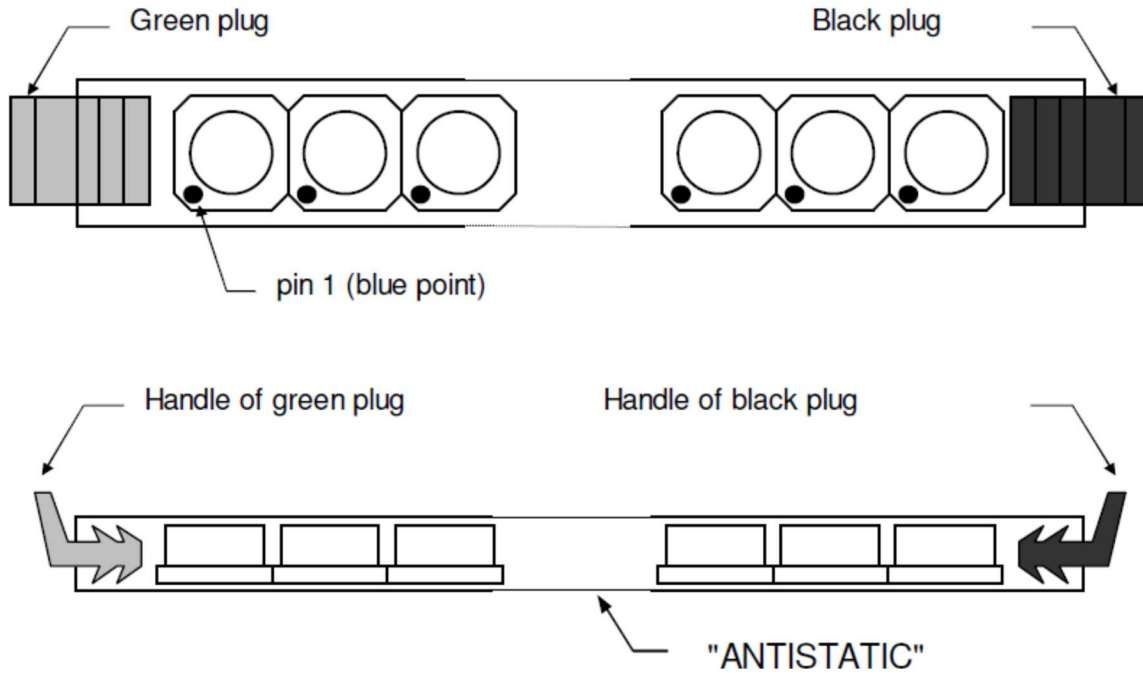

Figure 22: MS5803-07BA tube shipping package

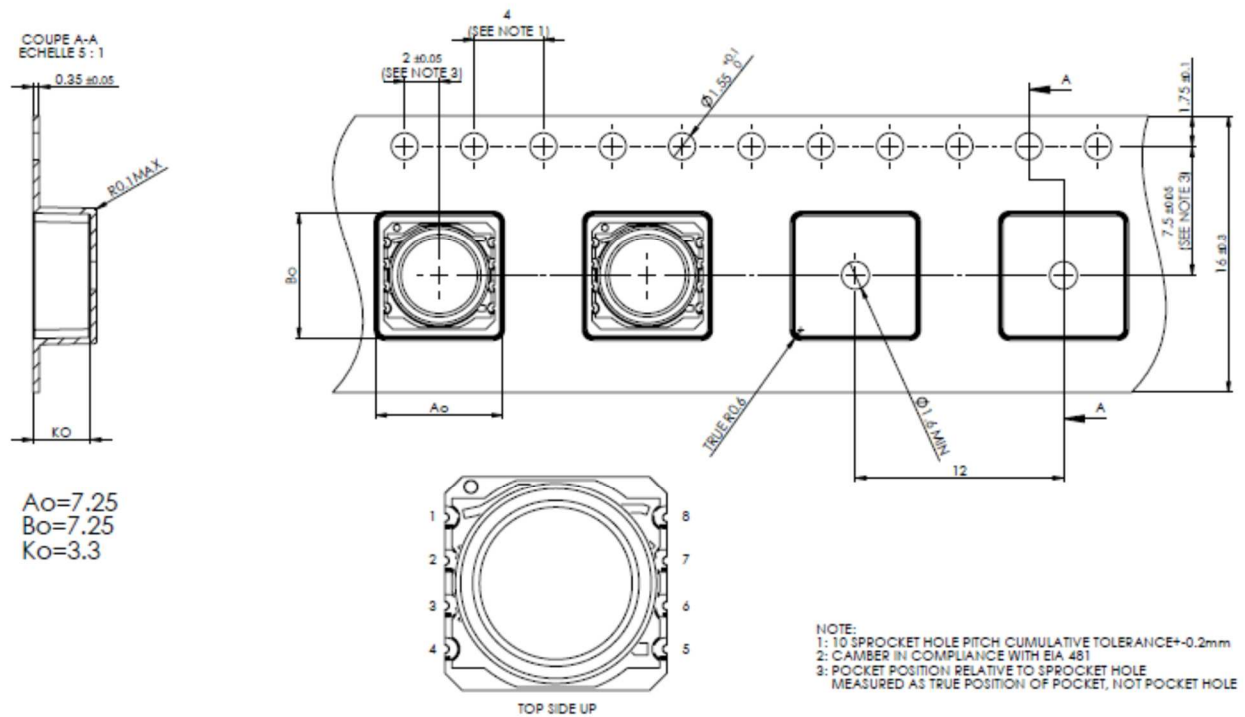

Figure 23: MS5803-07BA Tape & reel shipping package

MOUNTING AND ASSEMBLY CONSIDERATIONS

SOLDERING

Please refer to the application note AN808 available on our website for all soldering issues.

MOUNTING

The MS5803-07BA can be placed with automatic Pick & Place equipment using vacuum nozzles. It will not be damaged by the vacuum. Due to the low stress assembly the sensor does not show pressure hysteresis effects. It is important to solder all contact pads.

CONNECTION TO PCB

The package outline of the module allows the use of a flexible PCB for interconnection. This can be important for applications in watches and other special devices.

SEALING WITH O-RINGS

In products like outdoor watches the electronics must be protected against direct water or humidity. For those products the MS5803-07BA provides the possibility to seal with an O-ring. The protective cap of the MS5803-07BA is made of special anticorrosive stainless steel with a polished surface. In addition to this the MS5803-07BA is filled with silicone gel covering the sensor and the bonding wires. The O-ring (or O-rings) shall be placed at the outer diameter of the metal cap. This method avoids mechanical stress because the sensor can move in vertical direction.

CLEANING

The MS5803-07BA has been manufactured under cleanroom conditions. It is therefore recommended to assemble the sensor under class 10'000 or better conditions. Should this not be possible, it is recommended to protect the sensor opening during assembly from entering particles and dust. To avoid cleaning of the PCB, solder paste of type "no-clean" shall be used. Cleaning might damage the sensor!

ESD PRECAUTIONS

The electrical contact pads are protected against ESD up to 2 kV HBM (human body model). It is therefore essential to ground machines and personnel properly during assembly and handling of the device. The MS5803-07BA is shipped in antistatic transport boxes. Any test adapters or production transport boxes used during the assembly of the sensor shall be of an equivalent antistatic material.

DECOUPLING CAPACITOR

Particular care must be taken when connecting the device to the power supply. A minimum 100 nF ceramic capacitor must be placed as close as possible to the MS5803-07BA VDD pin. This capacitor will stabilize the power supply during data conversion and thus, provide the highest possible accuracy.

MS5803-07BA

Altimeter and diving pressure sensor

ORDERING INFORMATION

PART NUMBER	DESCRIPTION	Delivery Form
MS580307BA01-00	MS5803-07BA 7BAR Dual Range White Gel	Tube
MS580307BA01-50	MS5803-07BA 7BAR Dual Range White Gel	Tape & Reel TOP-UP
MS580307BA06-00	MS5803-07BA 7BAR Dual Range White Gel HE	Tube
MS580307BA06-50	MS5803-07BA 7BAR Dual Range White Gel HE T&R	Tape & Reel TOP-UP

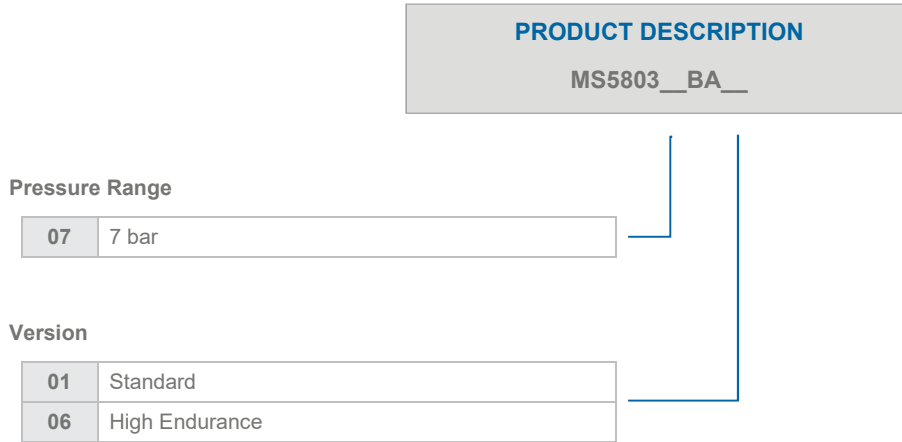

NORTH AMERICA

Measurement Specialties, Inc.,
a TE Connectivity company
Tel: 800-522-6752
Email: customercare.frm@te.com

EUROPE

Measurement Specialties (Europe), Ltd.,
a TE Connectivity Company
Tel: 800-440-5100
Email: customercare.bevx@te.com

ASIA

Measurement Specialties (China) Ltd.,
a TE Connectivity company
Tel: 0400-820-6015
Email: customercare.shzn@te.com

TE.com/sensorsolutions

Measurement Specialties, Inc., a TE Connectivity company.

Measurement Specialties, TE Connectivity, TE Connectivity (logo) and EVERY CONNECTION COUNTS are trademarks. All other logos, products and/or company names referred to herein might be trademarks of their respective owners.

The information given herein, including drawings, illustrations and schematics which are intended for illustration purposes only, is believed to be reliable. However, TE Connectivity makes no warranties as to its accuracy or completeness and disclaims any liability in connection with its use. TE Connectivity's obligations shall only be as set forth in TE Connectivity's Standard Terms and Conditions of Sale for this product and in no case will TE Connectivity be liable for any incidental, indirect or consequential damages arising out of the sale, resale, use or misuse of the product. Users of TE Connectivity products should make their own evaluation to determine the suitability of each such product for the specific application.

© 2015 TE Connectivity Ltd. family of companies All Rights Reserved.

X-ON Electronics

Largest Supplier of Electrical and Electronic Components

Click to view similar products for [Board Mount Pressure Sensors](#) category:

Click to view products by [TE Connectivity](#) manufacturer:

Other Similar products are found below :

[6407-249V-17343P](#) [6407-250V-09273P](#) [80527-25.0H2-05](#) [80541-B00000150-01](#) [80541-B00000200-05](#) [80554-00700100-05](#) [80568-00300050-01](#) [93.631.4253.0](#) [93.731.4353.0](#) [93.932.4553.0](#) [136PC150G2](#) [136PC15A1](#) [142PC95AW71](#) [142PC05DW70](#) [15PSI-G-4V](#) [1805-01A-L0N-B](#) [26PCBKT](#) [26PCCFA6D26](#) [26PCCFS2G](#) [26PCCVA6D](#) [93.632.7353.0](#) [93.731.3653.0](#) [93.931.4853.0](#) [93.932.4853.0](#) [SCDA120-XSC05DC](#) [185PC30DH](#) [20INCH-G-MV-MINI](#) [26PCAFJ3G](#) [26PCCEP5G24](#) [26PCDFA3G](#) [26PCJEU5G19](#) [ASCX15AN-90](#) [TSCSAAN001PDUCV](#) [DCAL401DN](#) [DCAL401GN](#) [XZ202798SSC](#) [XZ203676HSC](#) [6407-249V-09343P](#) [6407-250V-17343P](#) [SP370-25-116-0](#) [81794-B00001200-01](#) [HSCDLNN100PGAA5](#) [82681-B00000100-01](#) [81618-B00000040-05](#) [SSCDJNN015PAAA5](#) [TSCSAAN100PDUCV](#) [NBPDANN015PGUNV](#) [NBPLLNS150PGUNV](#) [142PC100D](#) [80541-B00000150-05](#)