

THIS DRAWING IS UNPUBLISHED. RELEASED FOR PUBLICATION

© COPYRIGHT - By - ALL RIGHTS RESERVED.

LOC	DIST	REVISIONS					
FT	0	P	LTR	DESCRIPTION	DATE	DWN	APVD
			F3	REVISED PER ECO-13-015432	01OCT2013	KH	MM

MATERIALS:  
 HOUSING: POLYAMIDE, UL94V-0, BLACK.  
 TERMINALS: COPPER ALLOY, TIN PLATED.  
 SCREWS: STEEL, ZINC PLATED.

ELECTRICAL:  
 RATING: 20A, UL & CSA.

MECHANICAL:  
 WIRE RANGE: 12-22 AWG.  
 MAXIMUM TIGHTENING TORQUE: 7 IN-LBS.

ENVIRONMENTAL:  
 CONTINUOUS OPERATING TEMP.: -40°C TO +105°C.

- 1 PRELIMINARY PART NUMBER.
- 2 SCREWS ARE BOTTOMED, NO THREAD INTERRUPT.
- 3 OBSOLETE PART NUMBER.
- 4 CAPTIVE SCREWS BACKED OUT TO 1.3 IN-LB TORQUE.
- 5 OBSOLETE PARTS: OBSOLETE CIS STREAMLINING PER D.RENAUD/D.SINISI
- 6 SCREWS ARE NICKEL PLATED BRASS

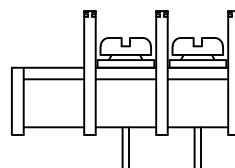
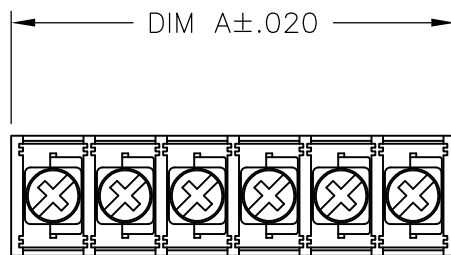

5 OBSOLETE ~~796922-6~~

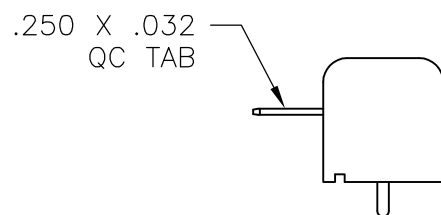
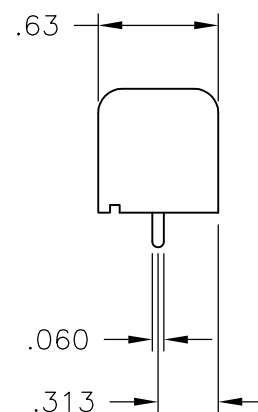
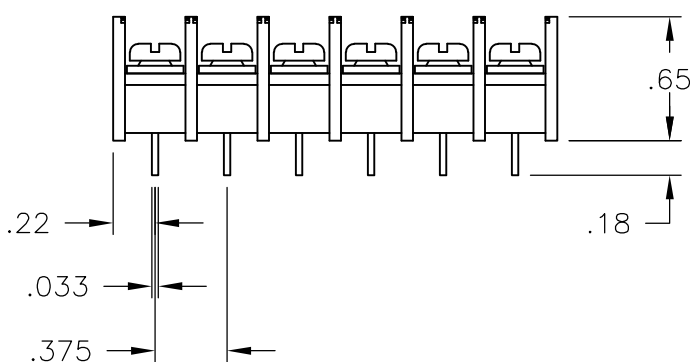

5 OBSOLETE ~~796922-7~~

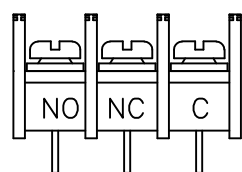

1-796922-8

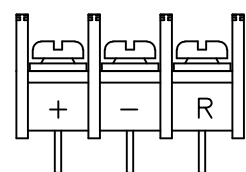

1-796922-9

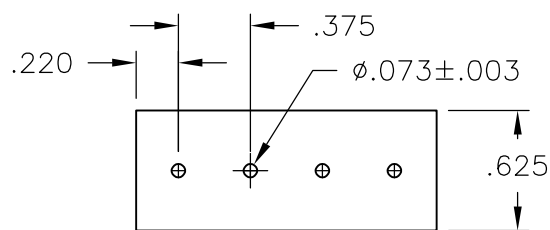

RECOMMENDED PCB LAYOUT

DIM A	NO OF POS	CATALOG NUMBER	PART NUMBER
6.436	17	NC6-P108-17	5-1437664-2
6.061	16	NC6-P108-16	5-1437664-1
5.686	15	NC6-P108-15	5-1437664-0
5.311	14	NC6-P108-14	4-1437664-9
4.936	13	NC6-P108-13	4-1437664-8
4.561	12	NC6-P108-12	4-1437664-7
4.186	11	NC6-P108-11	4-1437664-6
3.811	10	NC6-P108-10-068	1-796922-5
3.811	10	NC6-P108-10	4-1437664-4
3.436	9	NC6-P108-09-067	1-796922-4
3.436	9	NC6-P108-09	4-1437664-2
3.061	8	NC6-P108-08-069	1-796922-7
3.061	8	NC6-P108-08-066	1-796922-3
3.061	8	NC6-P108-08	4-1437664-1
2.686	7	NC6-P108-07-065	1-796922-2
2.686	7	NC6-P108-07-057	<del>796922-7</del>
2.686	7	NC6-P108-07	4-1437664-0
2.311	6	NC6-P108-06-064	1-796922-1
2.311	6	NC6-P108-06-054	<del>796922-3</del>
2.311	6	NC6-P108-06-049	3-1437664-9
2.311	6	NC6-P108-06	3-1437664-8
1.936	5	NC6-P108-05-063	1-796922-0
1.936	5	NC6-P108-05-052	3-1437664-7
1.936	5	NC6-P108-05	3-1437664-5
1.561	4	NC6-P106-04	6-1437664-2
1.561	4	NC6-P108-04-062	<del>796922-9</del>
1.561	4	NC6-P108-04	3-1437664-3
1.186	3	NC6-P108-03-289	1-796922-9
1.186	3	NC6-P108-03-290	1-796922-8
1.186	3	NC6-P108-03-056	<del>796922-6</del>
1.186	3	NC6-P108-03-501	1-796922-6
1.186	3	NC6-P108-03	3-1437664-1
.811	2	NC6-P108-02-061	<del>796922-8</del>
.811	2	NC6-P108-02	3-1437664-0

THIS DRAWING IS A CONTROLLED DOCUMENT.

DWN	S SCHLEGEL	03JUN03
CHK	H WAKEEM	6/3/03
APVD	H WAKEEM	6/3/03
PRODUCT SPEC	-	
APPLICATION SPEC	-	
WEIGHT	-	

STE TE Connectivity

NC6-P108-XX ASSEMBLY

SIZE	CAGE CODE	DRAWING NO	RESTRICTED TO
A3	00779	C-3-1437664-0	-

CUSTOMER DRAWING SCALE NTS SHEET 1 OF 2 REV F3

THIS DRAWING IS UNPUBLISHED. RELEASED FOR PUBLICATION  
 © COPYRIGHT - By - ALL RIGHTS RESERVED.

LOC	DIST	REVISIONS			
P	LTR	DESCRIPTION	DATE	DWN	APVD
FT	0	-	SEE SHEET 1	-	-

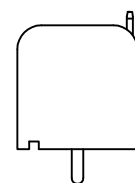
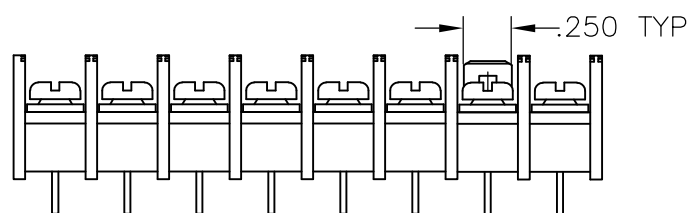
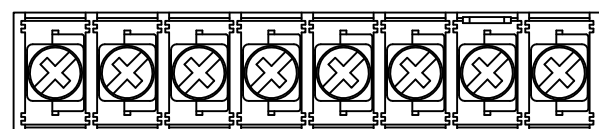

1-796922-7

9.061	24	NC6-P108-24	5-1437664-7
8.686	23	NC6-P108-23	796922-5
8.311	22	NC6-P108-22	5-1437664-6
7.936	21	NC6-P108-21	796922-4
7.561	20	NC6-P108-20	5-1437664-5
7.186	19	NC6-P108-19	5-1437664-4
6.811	18	NC6-P108-18	5-1437664-3
DIM A	NO OF POS	CATALOG NUMBER	PART NUMBER

THIS DRAWING IS A CONTROLLED DOCUMENT.		DWN S SCHLEGEL 03JUN03	 TE Connectivity			
DIMENSIONS: INCHES		CHK H WAKEEM 6/3/03				
TOLERANCES UNLESS OTHERWISE SPECIFIED:		APVD H WAKEEM 6/3/03	NAME			
0 PLC ± - 1 PLC ± - 2 PLC ± .01 3 PLC ± .005 4 PLC ± - ANGLES ± -		PRODUCT SPEC	NC6-P108-XX ASSEMBLY			
MATERIAL		APPLICATION SPEC	SIZE	CAGE CODE	DRAWING NO	RESTRICTED TO
FINISH		WEIGHT	A3	00779	C-3-1437664-0	-
CUSTOMER DRAWING			SCALE	SHEET	REV	
			NTS	2 OF 2	F3	

## X-ON Electronics

Largest Supplier of Electrical and Electronic Components

*Click to view similar products for [Barrier Terminal Blocks](#) category:*

*Click to view products by [TE Connectivity](#) manufacturer:*

Other Similar products are found below :

[6C1N03](#) [6PCR-02-008](#) [6PCR-05-008](#) [6PCR-08-008](#) [6PCR-21-006](#) [6PCV-06-008](#) [6PCV-10-009](#) [6PCV-15-008](#) [6STR-06-006](#) [6STR-08-006](#)  
[6STR-12-008](#) [6STR-14-008](#) [6STR-16-008](#) [6STR-17-008](#) [6STR-21-008](#) [6STR-25-008](#) [6STR-27-008](#) [6STV-03-006](#) [6STV-03-008](#) [6STV-04-006](#) [6STV-10-006](#) [6WWR-03](#) [6WWV-12-008](#) [6WWV-16-008](#) [7-1546701-0](#) [72212603](#) [72503-C](#) [72504-C-50](#) [73203](#) [76007](#) [7604-501LF](#)  
[77010-50](#) [796985-3](#) [796988-4](#) [7C1N08](#) [8-1437402-5](#) [8-1437402-7](#) [8-1546158-0](#) [870505](#) [870903](#) [8PCR-06-006](#) [8PCV-02-008](#) [8PCV-05-008](#)  
[8PCV-09-006](#) [8PCV-15-006](#) [8PCV-17-006](#) [8QCR-03-008](#) [8STV-04-006](#) [9-1437402-3](#) [A103104](#)