

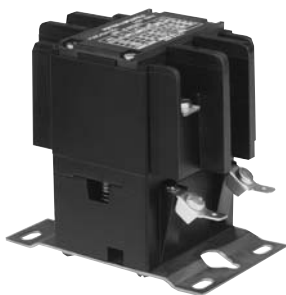

DC Coil



AC Coil

P30/P40 series

Definite Purpose Magnetic Contactor 30/40 Ampere Full Load 40/50 Ampere Resistive AC & DC Coils

File E22575

File LR15734

Users should thoroughly review the technical data before selecting a product part number. It is recommended that users also seek out the pertinent approvals files of the agencies/laboratories and review them to ensure the product meets the requirements for a given application.

Features

- AC and DC coils.
- Available with auxiliary switch.
- Variety of main contact terminals.
- For control of motors, power supplies, heating elements and lighting.

Contact Data @ 25°C

Arrangements: Up to 4 Form X (4PST-NO-DM)

Ratings: See contact rating table.

Material: Silver-cadmium oxide.

Expected Life: 200,000 operations at full load.

AC coil: 2 million operations, mechanical.

DC coil: 10 million operations, mechanical.

Minimum Contact Data: 3A @ 120VAC.

Main Contact Ratings

Type	Motor Rating in Amps, 3Ø3P or 1Ø2P				Resistive Rating @ 600V	Tungsten Rating @277V
	Full Load @ 600V	Locked Rotor				
		@ 240V	@480V	@ 600V		
P30	30A	180A	150A	120A	40A	40A
P40	40A	240A	200A	160A	50A	50A

P30 Electrical Discharge Lamp Control: 40A @ 240V (Delta), 40A @ 600V (Wye).

P40 Electrical Discharge Lamp Control: 50A @ 600V (Wye).

Type	Motor Rating in Horsepower			
		@ 120V	@ 240V	@ 440-600V
P30	1Ø2P	1.5HP	3HP	—
	3Ø3P	3HP	7.5HP	7.5HP
P40	1Ø2P	2HP	5HP	—
	3Ø3P	5HP	10HP	15HP

Auxiliary Snap-Action Switch

Arrangements: Up to 2 Form C (DPDT).

Rating: 10 amps at 120-250VAC @ 25°C.

Material: Silver.

Initial Dielectric Strength

Initial Breakdown Voltage: 2,200 rms minimum between all elements and between all elements to ground.

Coil Data @ 25°C

Voltage: From 12 to 120VDC, and 24 to 277VAC, 50/60 Hz.

Power: DC, 7.5 W; AC, 92VA, In rush; 12 VA Sealed.

Duty Cycle: Continuous.

Insulation Class: Class A, standard, Class B available.

Initial Insulation Resistance: 100 megohms, minimum.

Coil Data

Nominal VDC	Resistance (Ohms ± 10% @ 25° C)	Must Operate* Volts	Maximum Operating Volts	Nominal Coil Current (ma) @ Nominal Voltage
12	20.8	9	15	577
24	84	18	30	286
48	334	36	57	144
120	2,110	90	144	57

AC Voltage Rating	Nominal	Must Operate*
	50/60 Hz.	50/60 Hz.
24	24	20.4
120	110/120	94
240	208/240	177
277	277	236

*Applicable for vertical mounting, but not for upside-down mounting.

Note: Coil suppression is recommended for all DC coil units, particularly 120 and 240VDC coils.

Operate Data

Must-Operate Voltage: See coil data tables.

Environmental Data

Temperature Range: -55°C to +65°C.

Mechanical Data

Mounting: Universal mounting bracket. See outline drawings.

Termination:

Contacts: Binder screw, box lug, captive pressure plate, combination screw and dual .250" (6.35mm) quick connect, or combination box lug and dual .250" (6.35mm) quick connect. See Main Contact Terminal Options photo.

Coil: Combination 8-32 screw and .250" (6.35mm) quick connect.

Aux. Switch: .187" (4.75mm) quick connect.

Weight: 3 Pole Models: 25 oz. (709g) approximately.

4 Pole Models: 28 oz. (794g) approximately.

Ordering Information

Typical Part No. ▶	P30	P	42	A	1	4	P	1	-240										
<p>1. Type: P30 = Definite Purpose Contactor, 30 amp. P40 = Definite Purpose Contactor, 40 amp.</p>																			
<p>2. Auxiliary Switch: P = No Aux. Switch C = 1 Form C (SPDT) F = 2 Form C (DPDT)</p>																			
<p>3. Main Contact Arrangement:</p> <table border="0" style="width: 100%;"> <tr> <td style="width: 50%;">42 = 3 Form X (3PST-NO-DM)</td> <td style="width: 50%;">47 = 4 Form X (4PST-NO-DM)</td> </tr> <tr> <td>43 = 2 Form X (DPST-NO-DM)</td> <td>48 = 2 Form X (DPST-NO-DM)</td> </tr> <tr> <td> & 1 Form Y (SPST-NC-DB)</td> <td> & 2 Form Y (DPST-NC-DB)</td> </tr> <tr> <td>45 = 1 Form X (SPST-NO-DB)</td> <td>49 = 4 Form Y (4PST-NC-DB)</td> </tr> <tr> <td> & 2 Form Y (DPST-NC-DB)</td> <td>Other contact arrangements are available.</td> </tr> </table>										42 = 3 Form X (3PST-NO-DM)	47 = 4 Form X (4PST-NO-DM)	43 = 2 Form X (DPST-NO-DM)	48 = 2 Form X (DPST-NO-DM)	& 1 Form Y (SPST-NC-DB)	& 2 Form Y (DPST-NC-DB)	45 = 1 Form X (SPST-NO-DB)	49 = 4 Form Y (4PST-NC-DB)	& 2 Form Y (DPST-NC-DB)	Other contact arrangements are available.
42 = 3 Form X (3PST-NO-DM)	47 = 4 Form X (4PST-NO-DM)																		
43 = 2 Form X (DPST-NO-DM)	48 = 2 Form X (DPST-NO-DM)																		
& 1 Form Y (SPST-NC-DB)	& 2 Form Y (DPST-NC-DB)																		
45 = 1 Form X (SPST-NO-DB)	49 = 4 Form Y (4PST-NC-DB)																		
& 2 Form Y (DPST-NC-DB)	Other contact arrangements are available.																		
<p>4. Coil Control Input: A = Alternating Current, 50/60 Hz. D = Direct Current</p>																			
<p>5. Mounting and Installed Accessories: 1 = Standard Mounting</p>																			
<p>6. Main Contact Terminals:</p> <table border="0" style="width: 100%;"> <tr> <td style="width: 50%;">2 = Screw Terminals</td> <td style="width: 50%;">5 = Captive Pressure Plate</td> </tr> <tr> <td>3 = Screw Terminals & Dual .250" (6.35mm) Quick Connect</td> <td>6 = Box Lug & Dual .250" (6.35mm) Quick Connect</td> </tr> <tr> <td>4 = Box Lug</td> <td></td> </tr> </table>										2 = Screw Terminals	5 = Captive Pressure Plate	3 = Screw Terminals & Dual .250" (6.35mm) Quick Connect	6 = Box Lug & Dual .250" (6.35mm) Quick Connect	4 = Box Lug					
2 = Screw Terminals	5 = Captive Pressure Plate																		
3 = Screw Terminals & Dual .250" (6.35mm) Quick Connect	6 = Box Lug & Dual .250" (6.35mm) Quick Connect																		
4 = Box Lug																			
<p>7. Auxiliary Contact Terminals: P = No Auxiliary Switch C = .187" (4.75mm) Quick Connect</p>																			
<p>8. Coil Terminals: 1 = Combination 8-32* Screw Terminal and .250" (6.35mm) Quick Connect</p>																			
<p>9. Coil Voltage: 24, 120, 240 or 277VAC 12, 24 or 120VDC</p>																			

Our authorized distributors are more likely to maintain the following items in stock for immediate delivery.

P30P42A12P1-120	P40P42A12P1-24
P30P42D12P1-24	P40P42A12P1-120
P30P47A12P1-120	P40P42A12P1-240
P30P47D12P1-24	P40P42D12P1-24

Outline Dimensions

3 Pole Models

AC Coil

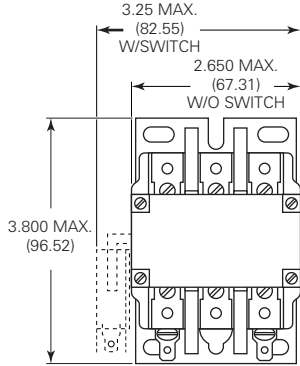

DC Coil

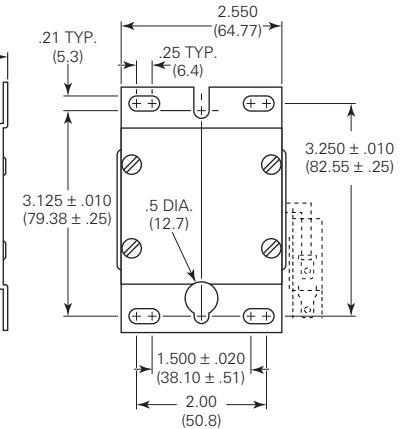
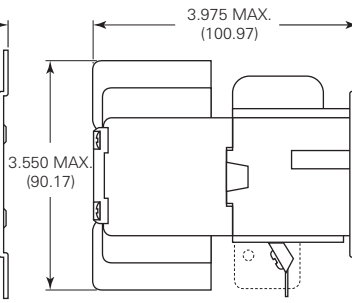
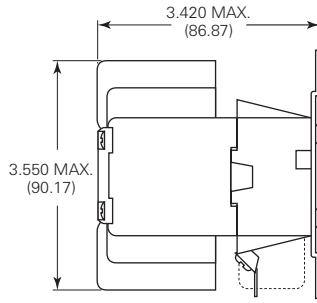

4 Pole Models

AC Coil

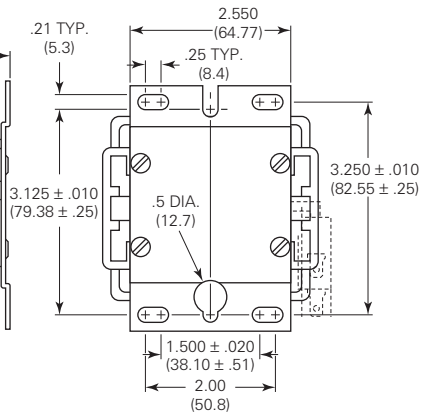
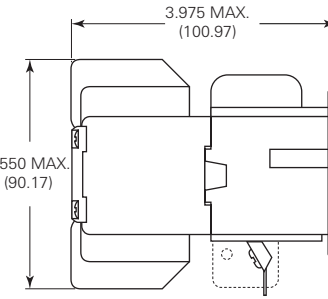
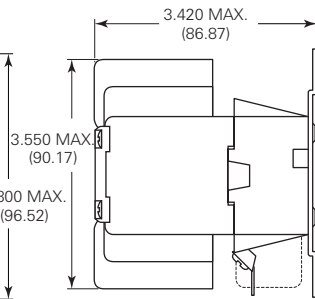
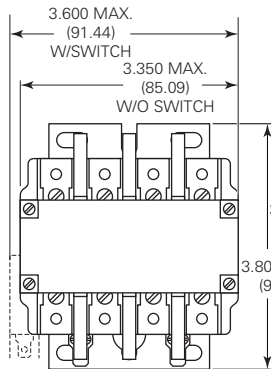

Contact Terminal Options

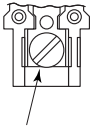
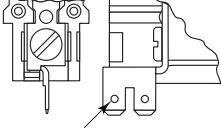
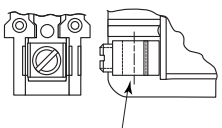
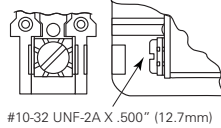
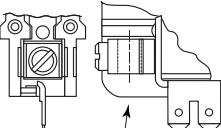
<p>Code 2</p>  <p>#10-32 UNF-2A X .375" (9.525mm) Binder Terminal Screw 15S365 accepts the following wire size: Solid, Single — 8 AWG</p>	<p>Code 3</p>  <p>Dual .250" (6.35mm) Quick Connect 26A945 #10-32 UNF-2A X .375" (9.525mm) Binder Terminal Screw 15S365 accepts the following wire size: Solid, Single — 8 AWG</p>	<p>Code 4</p>  <p>Box Lug (Keyed) 24C540 with 15S361 & 15S364 Screws Accepts the following wire sizes: Solid, Single — 14-4 AWG</p>	<p>Code 5</p>  <p>#10-32 UNF-2A X .500" (12.7mm) Screw with Captive Pressure Plate 15S362 Accepts the following wire sizes: Solid, Single — 22-8 AWG Solid, Double — 22-14 AWG Stranded, Single — 22-8 AWG Stranded, Double — 22-16 AWG</p>	<p>Code 6</p>  <p>Dual .250" (6.35mm) Quick Connect 26A945 Box Lug 9P30X3 Accepts the following wire sizes: Solid, Single — 14-4 AWG</p>
---	--	---	---	--

Main Contact Ordering and Replacement Information

Contact Replacement Kits

Contact replacement kits for 3 pole models include 3 contact pressure springs, 3 movable contact assemblies and 6 stationary contact assemblies. Kits for 4 pole models include 4 contact pressure springs, 4 movable contact assemblies and 8 stationary contact assemblies. Contact replacement kits are for use only on those models with form X contact arrangements.

Kits for P30 contactors:

- 3 Form X models - Kit No. 9P30X1
- 4 Form X models - Kit No. 9P30X2

Kits for P40 contactors:

- 3 Form X models - Kit No. 9P40X1
- 4 Form X models - Kit No. 9P40X2

To Replace Contacts:

1. Remove screws holding dust cover in place, and remove cover.
 2. Compress and remove contact pressure springs.
 3. Lift movable contacts and remove.
 4. Remove screws holding stationary contact in place, and remove contacts.
 5. Reverse the above procedure to install new stationary and movable contacts.
- Caution:** Do not overtighten the screws, as it is possible to strip the threads.

X-ON Electronics

Largest Supplier of Electrical and Electronic Components

Click to view similar products for [Contactors - Electromechanical category:](#)

Click to view products by [TE Connectivity manufacturer:](#)

Other Similar products are found below :

[6-1618400-7](#) [686-117111](#) [686-120111](#) [686-924](#) [686-948](#) [70-901](#) [70-914](#) [MB-3D-6](#) [MC-22A/4-AC120V](#) [8-1616943-9](#) [8-1672124-5](#)
[A40-30-10-84](#) [120-905](#) [A701U](#) [120-904](#) [1393132-9](#) [154-905](#) [154-912](#) [154-913](#) [154-915](#) [154-902](#) [154-910](#) [AVR743D](#) [B6-40-00-84](#) [B7-40-00-84](#) [1616017-5](#) [1616021-1](#) [MVDILM](#) [HP-11D-24](#) [P25-E5019-1](#) [P30C47A12D1-120](#) [P40C47A12D1-120](#) [P40P47D13P1-24-01](#) [CA7-12-10-240](#) [CA7-72-00-24Z](#) [90-162](#) [9-1393132-2](#) [2NC4F0222](#) [A275KXXV2-120VAC](#) [ACC338UMM20](#) [AF80-30-11-13](#) [SZ-B1](#) [CGC-9A-120](#) [3GC2H0M22](#) [3NC0T0A22](#) [3NC1Q0A22](#) [3NC2H0A22](#) [3NC2T0122/SE](#) [3TF3400-0BB4](#) [MC-12B-DC24V](#)