

MINIMUM INSERTION LOSS IN dB LINE TO GROUND IN 50 OHM CIRCUIT								MINIMUM INSERTION LOSS IN dB LINE TO LINE IN 50 OHM CIRCUIT							
CURRENT RATING	FREQUENCY MHz							CURRENT RATING	FREQUENCY MHz						
	0.15	0.5	1	3	5	10	30		0.15	0.5	1	3	5	10	30
H MODELS															
3 AMP	21	27	30	29	26	23	15	3 AMP	4	12	18	31	40	48	41
6 AMP	11	15	17	19	18	16	13	6 AMP	4	12	16	26	35	40	35
10 AMP	5	8	10	12	11	11	10	10 AMP	4	12	16	26	33	40	32
S MODELS															
3 AMP	21	27	33	40	44	50	32	3 AMP	4	12	15	30	48	50	45
6 AMP	12	17	23	32	36	44	30	6 AMP	4	12	15	22	42	55	45
10 AMP	5	10	13	23	27	35	27	10 AMP	4	12	15	22	42	55	45

RECOMMENDED PANEL CUTOUTS

STYLE	DIMENSION 'A'		DIMENSION B
	UNSHIELDED	SHIELDED	
PS	1.06	1.12	2.201 *
PSL	1.12		2.201 *
PE	1.12	1.12	2.201 *
PM	1.06	1.12	2.13
PSC	1.06	1.12	2.52
PSJ	1.06	1.12	2.6

* FOR PANEL THICKNESS OF 0.031"-0.079" ONLY.
USE 2.213 FOR PANEL THICKNESS OF 0.083"-0.114"

SHEET 1 OF 2

ECN#	APPRVD	DATE	REV
10-002963	ELC	19AUG10	C
12-015327	TAM	22AUG12	D



NOTE: FOR SNAP-IN APPLICATIONS, THE A SIDES MUST HAVE A .020 R. ON INSTALLATION SIDE.

C - EXTENDER



J-SERIES EXTENDER



MOUNTING STYLE
 E = SEE VIEW ABOVE
 S = SEE VIEW
 M = SEE VIEW
 D = NONE
 F = FN260
 J = J SERIES
 L = L SERIES
 O = BLANK
 S = DOUBLE POLE SINGLE THROW
 O = SINGLE VOLTAGE
 S = DUAL VOLT. SELECT (SMPS)
 X = DUAL VOLT. SELECT (SERIES/PARALLEL)

EXTENDER
 O = NO SHIELD
 A = FILTER SHIELD
 B = COMPLETE SHIELD

OPTIONS
 O = NO FILTER
 3 = 3 AMPS
 6 = 6 AMPS
 X = 10 AMPS

SWITCH
 O = NO FILTER
 B = INTERCONNECTION BLOCK
 H = MEDICAL FILTER
 S = GENERAL PURPOSE
 D = DUAL FUSE
 S = SINGLE FUSE

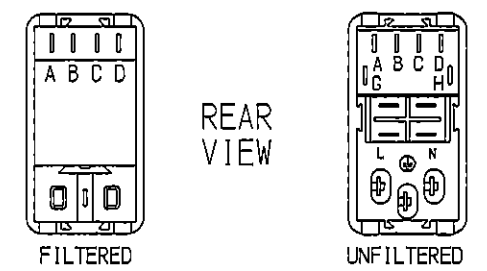
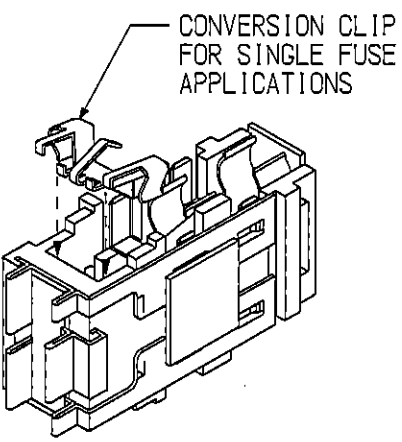

Tyco Electronics
CORCOM PRODUCTS, 620 S. BUTTERFIELD RD. MUNDELEIN IL 60060

CUSTOMER DRAWING
P-SERIES

TYCO ELECTRONICS PART NO.			
SCALE: 1:2	DATE: 2-4-97	DRAWING NUMBER: P-SERIES	REV. D
DRW. BY:	ORIG:		

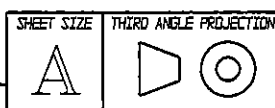

THIS INFORMATION IS CONFIDENTIAL AND PROPRIETARY TO TYCO ELECTRONICS CORPORATION AND ITS WORLDWIDE SUBSIDIARIES AND AFFILIATES. IT MAY NOT BE DISCLOSED TO ANYONE OTHER THAN TYCO ELECTRONICS PERSONNEL, WITHOUT WRITTEN AUTHORIZATION FROM TYCO ELECTRONICS CORPORATION, HARRISBURG, PENNSYLVANIA USA.

SPECIFICATIONS

HIPOT RATING (ONE MINUTE)

LINE TO GROUND:	1500 VAC
LINE TO LINE:	1450 VDC
OPERATING FREQUENCY:	50/60 Hz
RATED VOLTAGE:	120/250 VAC
OPERATING VOLTAGES:	115/230 VAC
SELECTABLE OR FIXED:	SELECTABLE FUSEHOLDER ACCEPTS 1 OR 2 FUSES 1/4" x 1-1/4" OR 5 x 20mm

OPERATING AMBIENT TEMP.:	-10°C TO +40°C
STORAGE TEMPERATURE:	-40°C TO +85°C
HUMIDITY:	21 DAYS, 40°C @95% RH.
CURRENT OVERLOAD TEST:	6 TIMES I _R FOR 8 SECONDS

NONFILTERED MODELS

RATED CURRENT; I _R :	10A @ 120 VAC
	10A @ 250 VAC

FILTERED MODELS

MAXIMUM LEAKAGE CURRENT, EACH LINE TO GROUND	① 120 VAC 60Hz:	H MODELS 2μA
		S MODELS 0.25m
	② 250 VAC 50Hz:	H MODELS 5μA
		S MODELS 0.50mA

RATED CURRENT; I _R :	3, 6 & 10 AMP MODELS AVAILABLE
---------------------------------	--------------------------------

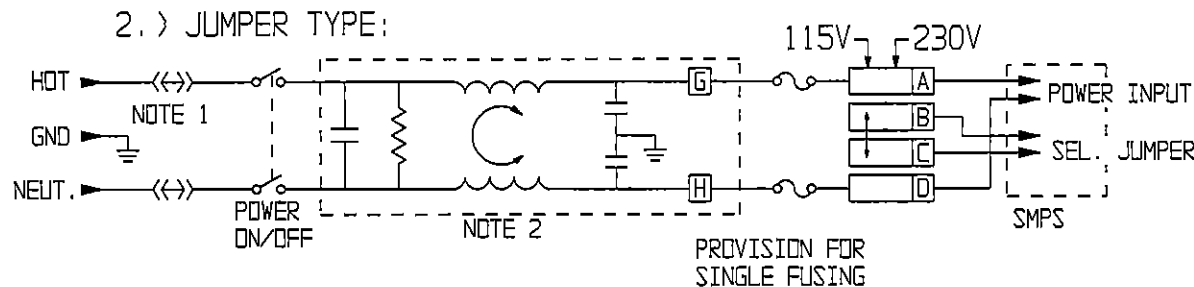
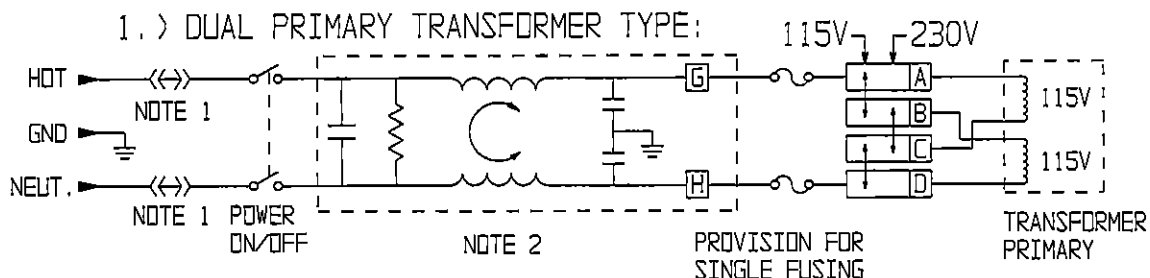

NOTE 1: JUMPERS ARE REQUIRED IF A FILTER OR INTERCONNECTION MODULE IS NOT USED.

NOTE 2: LOCATION OF OPTIONAL FILTER. JUMPERS ARE REQUIRED IF A FILTER OR INTERCONNECTION MODULE IS NOT USED.

GENERAL NOTES:

- CONVERSION CLIP PROVIDED ON FUSEHOLDER FOR SINGLE FUZE MODELS.
- SWITCH: DOUBLE INSULATED RATED FOR 10,000 OPERATIONS AT FULL LOAD. 51 AMP INRUSH CAPABILITY.
- TERMINALS: FOUR 0.187" x 0.032" QUICK CONNECT TABS ONE SOLDER TERMINAL

SAFETY ORGANIZATIONS

THIS FILTER HAS BEEN FORMALLY RECOGNIZED, CERTIFIED OR APPROVED BY THE LISTED AGENCY. THEREFORE, ALL TEST/REQUIREMENTS SPECIFIED IN THE LATEST REVISION OF THE FOLLOWING AGENCY STANDARDS HAVE BEEN MET:

UL RECOGNIZED
CSA CERTIFIED
VOE APPROVED

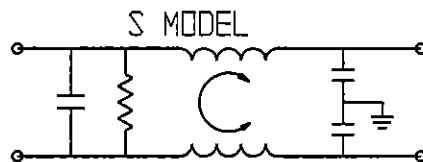
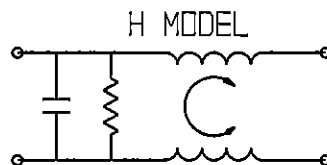

SEE INDIVIDUAL CUSTOMER DRAWINGS FOR OTHER (L AND Z) P-SERIES VERSIONS.

 CORCOM PRODUCTS, 620 S. BUTTERFIELD RD. MUNDELEIN IL 60060			
CUSTOMER DRAWING P-SERIES			
TYCO ELECTRONICS PART NO.			
SCALE: NA	DATE: 2/4/97	DRAWING NUMBER:	REV.:
DRW. BY:	ORIG:	P-SERIES	D

SHEET SIZE	THIRD ANGLE PROJECTION
A	

THIS INFORMATION IS CONFIDENTIAL AND PROPRIETARY TO TYCO ELECTRONICS CORPORATION AND ITS WORLDWIDE SUBSIDIARIES AND AFFILIATES. IT MAY NOT BE DISCLOSED TO ANYONE OTHER THAN TYCO ELECTRONICS PERSONEL. WITHOUT WRITTEN AUTHORIZATION FROM TYCO ELECTRONICS CORPORATION. HARRISBURG, PENNSYLVANIA USA.

X-ON Electronics

Largest Supplier of Electrical and Electronic Components

Click to view similar products for [AC Power Entry Modules](#) category:

Click to view products by [TE Connectivity](#) manufacturer:

Other Similar products are found below :

[0098.0050](#) [6167.0002](#) [6609100-2](#) [7-6609955-2](#) [FKI2-50-6/M5](#) [FN361-6-06](#) [FN389-4-22](#) [FN9226B-6-02](#) [FN9233S1-10-06](#) [FN9233S1-8-06](#)
[FN9233S1B-8-06](#) [FN9233S1R-1-06](#) [FN9233S1R-12-06](#) [FN9233SB-1-06](#) [FN9233SB-12-06](#) [FN9233SB-8-06](#) [FN9233SR-10-06](#) [FN9244B-15-06HI](#) [FN9244EB-3-06](#) [FN9244EB-8-06](#) [FN9244ER-15-06](#) [FN9244ER-8-06](#) [FN9244ES1-8-06](#) [FN9244ESB-8-06](#) [FN9244R-12-06](#)
[FN9244S1-12-06](#) [FN9244S1R-3-06](#) [FN9244SB-8-06](#) [FN9244SR-6-06](#) [FN9244U-3-06](#) [FN9244U-8-06](#) [8-6609940-2](#) [PE00SSSXB](#) [Fuse-H-EUR-1](#) [Fuse-H-USA-1](#) [PM00XD000](#) [A-0701-HT-H](#) [15EJMS8](#) [1-6609941-2](#) [200JM6-2](#) [CA121003-6](#) [SK-1015\(F1-5\)](#) [161-R3015-E](#) [1-6609153-2](#) [FN323-1-05](#) [FN9233B-8-06](#) [FN9233EB-1-06](#) [FN9233ES1R-10-06](#) [FN9233R-12-06](#) [FN9233S-10-06](#)