

**PRD Series Power Relay**

- Contact ratings to 50A
- Magnetic blowouts available for switching DC loads
- Contact arrangement up to 2 form C (2CO)
- 1 form C auxiliary switch available
- UL class B insulation

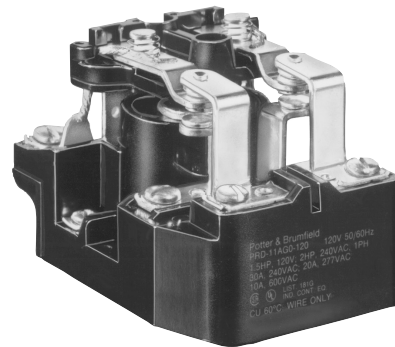

Typical applications  
Industrial controls, lighting.

**Approvals**

UL E22575; CSA LR15734;  
Models with all screw terminals are UL Listed. Others are UL Recognized.  
Technical data of approved types on request.

**Contact Data**

Contact arrangement	1 and 2 form A (NO); 1 and 2 form C (CO); 1 form X (NO-DM)
Rated voltage	600VAC, 125VDC
Rated current	50A
Contact material	Ag, AgCdO, W
Min. recommended contact load	1A, 12VDC or 12VAC
Initial contact resistance	75mΩ max.
Initial voltage drop	75mV
Frequency of operation	7200 ops/hr
Operate/releases time max.	40/20ms
Bounce time max.	10ms

**Contact ratings**

Type	Load	Cycles
<b>UL 508<sup>1)</sup></b>		
Models with screws or quick connects for main terminals		
Code Y, Ag, 1 pole		
	25A, 277VAC	100x10 <sup>3</sup>
	1HP, 120VAC	100x10 <sup>3</sup>
	2HP, 250VAC	100x10 <sup>3</sup>
	10A, 600VAC	100x10 <sup>3</sup>
	7A, 50VDC, resistive	100x10 <sup>3</sup>
Code Y, Ag, 2 pole		
	25A, 240VAC	100x10 <sup>3</sup>
	20A, 277VAC	100x10 <sup>3</sup>
	1HP, 120VAC	100x10 <sup>3</sup>
	2HP, 250VAC	100x10 <sup>3</sup>
	7A, 50VDC, resistive	100x10 <sup>3</sup>
	10A, 600VAC	100x10 <sup>3</sup>
Code G, AgCdO, 1 pole		
	30A, 277VAC, resistive	100x10 <sup>3</sup>
	1.5HP, 120VAC	100x10 <sup>3</sup>
	2HP, 250VAC	100x10 <sup>3</sup>
	10A, 600VAC	100x10 <sup>3</sup>
Code G, AgCdO, 2 pole		
	30A, 240VAC	100x10 <sup>3</sup>
	20A, 277VAC	100x10 <sup>3</sup>
	1.5HP, 120VAC	100x10 <sup>3</sup>
	2HP, 250VAC	100x10 <sup>3</sup>
	10A, 600VAC	100x10 <sup>3</sup>

1) Any PRD relay deviating electrically or physically from the standard models in the table is not UL or CSA listed. All horsepower ratings are for single phase motors..

**Contact ratings (continued)**

Type	Load	Cycles
<b>UL 508<sup>1)</sup></b>		
Models with screws or quick connects for main terminals		
Code F, AgCdO, 1 pole		
	50A, 240VAC, general purpose <sup>2)</sup>	20x10 <sup>3</sup>
	30A, 277VAC, resistive	100x10 <sup>3</sup>
	1.5HP, 120VAC	100x10 <sup>3</sup>
	2HP, 250VAC	100x10 <sup>3</sup>
	10A, 600VAC	100x10 <sup>3</sup>
Code F, AgCdO, 2 pole		
	50A, 240VAC, general purpose <sup>2)</sup>	20x10 <sup>3</sup>
	30A, 240VAC	100x10 <sup>3</sup>
	20A, 277VAC	100x10 <sup>3</sup>
	1.5HP, 120VAC	100x10 <sup>3</sup>
	2HP, 250VAC	100x10 <sup>3</sup>
	10A, 600VAC	100x10 <sup>3</sup>
Code H, Ag with magnetic blowout, 1 or 2 pole		
	20A, 125VDC	100x10 <sup>3</sup>
	1/3HP, 125VDC	100x10 <sup>3</sup>
Code J, AgCdO with magnetic blowout, 1 or 2 pole		
	20A, 125VDC	100x10 <sup>3</sup>
	1/3HP, 125VDC	100x10 <sup>3</sup>
Code N, W stationary with AgCdO movable, 1 or 2 pole		
	25A, 250VAC	100x10 <sup>3</sup>
	1HP, 125VAC	100x10 <sup>3</sup>
	2HP, 250VAC	100x10 <sup>3</sup>

<b>UL 508<sup>1)</sup></b>		
Models with box lugs for main terminals		
Code P, Ag, 1 form X		
	50A, 277VAC, general purpose	100x10 <sup>3</sup>
	30A, 277VAC, ballast	6x10 <sup>3</sup>
	15A, 277VAC, tungsten	6x10 <sup>3</sup>
	102LRA, 17FLA, 240VAC	30x10 <sup>3</sup>
	120LRA, 20FLA, 120VAC	30x10 <sup>3</sup>
	1.5HP, 120VAC	30x10 <sup>3</sup>
	3HP, 240VAC	30x10 <sup>3</sup>

**Factory ratings**

Models with box lugs for main terminals		
Code R, Ag with magnetic blowout, 1 form X		
	60A, 28VDC, resistive	100x10 <sup>3</sup>
	30A, 125VDC	100x10 <sup>3</sup>

Mechanical endurance DC Coil, 1x10<sup>6</sup> ops.; AC Coil 5x10<sup>5</sup> ops.

**Auxiliary Snap-Action Switch Contact Data**

Contact arrangement	1 form C (CO)
Rating	5A, 120VAC, 60Hz., 25°C
Contact material	Ag

**PRD Series Power Relay (Continued)**

**Coil Data**

Coil voltage range	6 to 110VDC 6 to 480VAC
Coil insulation system according UL	Class B

**Coil versions, DC coil**

Coil code	Rated voltage VDC	Operate voltage VDC	Release voltage VDC	Coil resistance $\Omega \pm 10\%$	Rated coil power W
6	6	4.5	0.6	18	2
12	12	9	1.2	71	2
24	24	18	2.4	288	2
48	48	36	4.8	1150	2
110	110	82.5	11	6050	2

All figures are given for coil without preenergization, at ambient temperature +23°C.  
Other coil voltages on request.

**Coil versions, AC coil**

Coil code	Rated voltage VAC	Operate voltage VAC	Release voltage VAC	Coil resistance $\Omega \pm 15\%$	Rated coil power VA
6	6	5.1	0.6	0.86	9.8
12	12	10.2	1.2	3.2	9.8
24	24	20.4	2.4	12	9.8
120	120	102	12	290	9.8
240	240	204	24	1200	9.8
480	480	408	48	4500	9.8

All figures are given for coil without preenergization, at ambient temperature +23°C.  
Other coil voltages on request.

**Insulation Data**

Initial dielectric strength	
between open contacts	2000V <sub>rms</sub>
between contact and coil	2000V <sub>rms</sub>
between adjacent contacts	2000V <sub>rms</sub>
Initial insulation resistance	
between insulated elements	100M $\Omega$

**Other Data**

Material compliance: EU RoHS/ELV, China RoHS, REACH, Halogen content refer to the Product Compliance Support Center at [www.te.com/customer-support/rohssupportcenter](http://www.te.com/customer-support/rohssupportcenter)

Ambient temperature  
AC coil: -55°C to 45°C  
DC coil: -55°C to 80°C

Category of environmental protection  
IEC 61810

Terminal type RT0 - open relay

Weight 284g

Packaging/unit tray/20 pcs., box/40pcs.

**Accessories**

Product Code	Description
35D013	Metal dust cover

**Dimensions**

PRD/PRDA 1, 3, 5 and 7

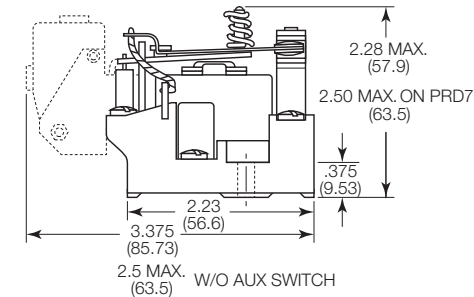
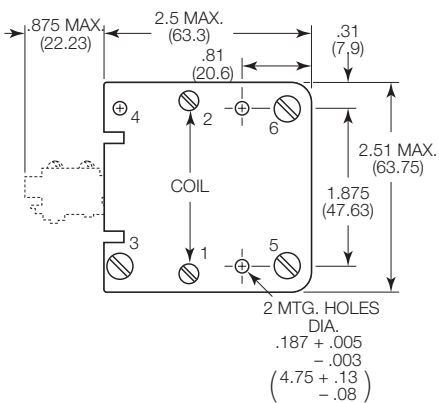

PRD/PRDA 11

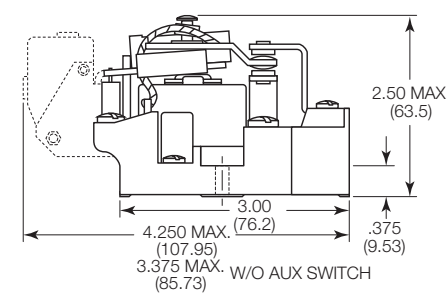
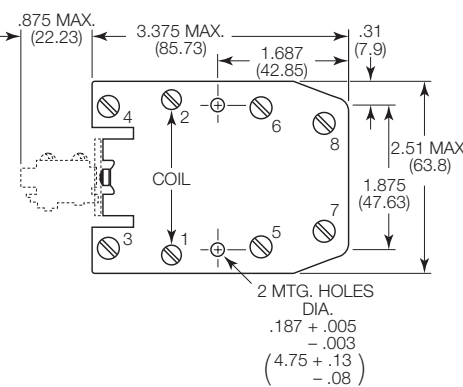

PRD-3\_P and R

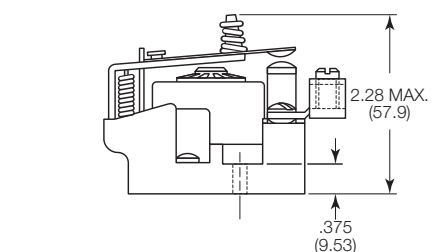
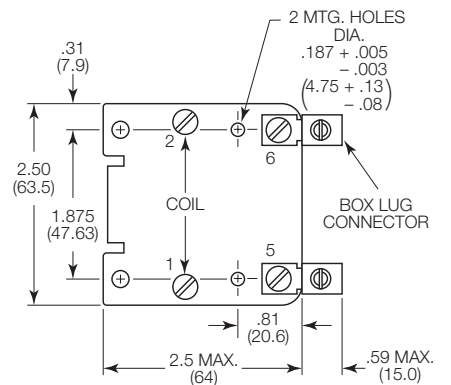



**PRD Series Power Relay (Continued)**

Product Code	Arrangement	Material	Coil	Terminals	Part Number	
PRD-3AY0-120	1 form X, 1 NO-DM	Ag	120VAC	Screw	7-1393127-9	
PRD-3AG0-120		AgCdO, 30A			6-1393127-9	
PRD-3AJ0-120		AgCdO, mag blowout			7-1393127-4	
PRD-3AJ3-24	1 form C, 1 CO		24VAC	Screw / QC	7-1393127-5	
PRD-3DH0-24		Ag, mag blowout	24VDC	Screw	8-1393127-6	
PRD-3DY0-12		Ag	12VDC		9-1393127-5	
PRD-3DY0-24			24VDC		9-1393127-6	
PRD-3DY0-110				110VDC		9-1393127-4
PRD-5AY0-24				24VAC		1393128-6
PRD-5AY0-120			120VAC		1393128-5	
PRD-5AY1-120				QC	1-1393128-1	
PRD-5AY0-240			240VAC	Screw	1393128-7	
PRD-5DF0-12	2 form A, 2 NO	AgCdO, 50A	12VDC		2-1423100-4	
PRD-5DY0-12		Ag			1-1393128-6	
PRD-5DY0-24			24VDC		1-1393128-7	
PRD-7AG0-120		AgCdO, 30A	120VAC		9-1393129-5	
PRD-7AY0-24	2 form C, 2 CO	Ag	24VAC		1393130-9	
PRD-7AY0-120				120VAC		1393130-7
PRD-7AY0-240				240VAC		1-1393130-0
PRD-7AY3-120				120VAC	Screw / QC	1-1393130-2
PRD-7DG0-24			AgCdO, 30A	24VDC	Screw	1-1393130-6
PRD-7DH0-48			Ag, mag blowout	48VAC		2-1393130-1
PRD-7DY0-12		Ag	12VDC		2-1393130-8	
PRD-7DY0-24			24VDC		2-1393130-9	
PRD-11AF0-240		AgCdO, 50A	240VAC		3-1423100-0	
PRD-11AG0-24		AgCdO, 30A	24VAC		1-1393127-1	
PRD-11AG0-120			120VAC		1393127-9	
PRD-11AG0-240			240VAC		1-1393127-2	
PRD-11AH0-120		Ag, mag blowout	120VAC		1-1393127-6	
PRD-11AY0-24		Ag	24VAC		2-1393127-9	
PRD-11AY0-120			120VAC		2-1393127-6	
PRD-11AY0-240			240VAC		3-1393127-0	
PRD-11AY0-480			480VAC		3-1393127-1	
PRD-11DF0-12		AgCdO, 50A	12VDC		2-1423100-2	
PRD-11DF0-110			110VDC		2-1423100-9	
PRD-11DG0-12		AgCdO, 30A	12VDC		3-1393127-5	
PRD-11DG0-24			24VDC		3-1393127-8	
PRD-11DH0-12		Ag, mag blowout	12VDC		4-1393127-7	
PRD-11DH0-24			24VDC		4-1393127-9	
PRD-11DH0-48			48VDC		5-1393127-0	
PRD-11DH0-110			110 VDC		4-1393127-6	
PRD-11DJ0-24		AgCdO, mag blowout	24 VDC		5-1393127-5	
PRD-11DY0-12		Ag	12 VDC		6-1393127-1	
PRD-11DY0-24			24 VDC		6-1393127-2	
PRD-11DY0-48			48 VAC		6-1393127-3	
PRD-11DY0-110			110 VDC		6-1393127-0	
PRDA-11AGA-120		AgCdO, 30A	120 VAC		7-1393131-4	
PRDA-11AYA-120					7-1393131-9	

**PRD accessory**

Product Code	Description	Part Number
35D013	Metal dust cover enclosure	5-1393158-2



**35D013 Dust Cover**

PRD dust cover has a steel base with knockouts for 0.5" (12.7mm) dia. conduit and a cover fitted with two screws. Fits PRD relays, except with auxiliary contacts. Finished in gray baked enamel.

**Mounting:**  
Three No. 10 holes on 1.875" (47.63mm) x 4.125" (104.77mm) centers.

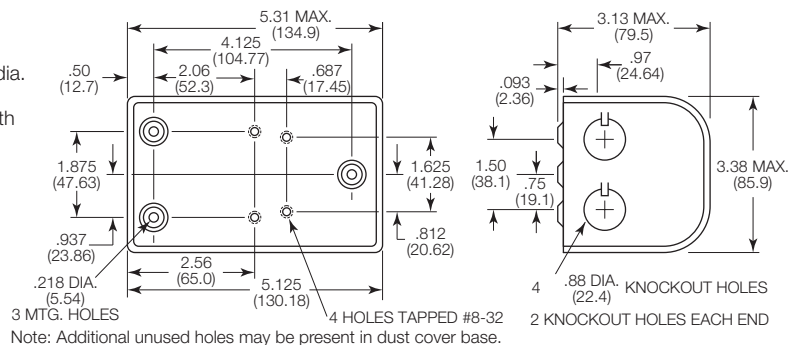

Note: Additional unused holes may be present in dust cover base.

## X-ON Electronics

Largest Supplier of Electrical and Electronic Components

*Click to view similar products for [General Purpose Relays](#) category:*

*Click to view products by [TE Connectivity](#) manufacturer:*

Other Similar products are found below :

[PCN-105D3MH,000](#) [59641F200](#) [5JO-1000CD-SIL](#) [LY1SAC110120](#) [5X827E](#) [5X837F](#) [5X840F](#) [5X842F](#) [5X848E](#) [LY2N-AC120](#) [LY2S-AC220/240](#) [LY2-US-AC120](#) [LY3-US-AC120](#) [LY4F-UA-DC12](#) [LY4F-UA-DC24](#) [LY4F-US-AC120](#) [LY4F-US-AC240](#) [LY4F-US-DC24](#) [LY4F-VD-AC110](#) [LYQ20DC12](#) [M115C60](#) [M115N010](#) [M115N0150](#) [6031007G](#) [603-12D](#) [61211T0B4](#) [61212T400](#) [61222Q400](#) [61243B600](#) [61243C500](#) [61243Q400](#) [61311BOA2](#) [61311BOA6](#) [61311BOA8](#) [61311C0A2](#) [61311COA1](#) [61311COA6](#) [61311F0A2](#) [61311QOA1](#) [61311QOA4](#) [61311T0D6](#) [61311TOA6](#) [61311TOA7](#) [61311TOB3](#) [61311TOB4](#) [61311U0A6](#) [61312Q600](#) [61312T400](#) [61312T600](#) [61313U200](#)