

| MINIMUM INSERTION LOSS IN dB LINE TO GROUND IN 50 OHM CIRCUIT | | | | | | | | MINIMUM INSERTION LOSS IN dB LINE TO LINE IN 50 OHM CIRCUIT | | | | | | | |
|--|---------------|-----|----|----|----|----|----|--|---------------|-----|----|----|----|----|----|
| CURRENT RATING | FREQUENCY MHz | | | | | | | CURRENT RATING | FREQUENCY MHz | | | | | | |
| | 0.15 | 0.5 | 1 | 3 | 5 | 10 | 30 | | 0.15 | 0.5 | 1 | 3 | 5 | 10 | 30 |
| H MODELS | | | | | | | | | | | | | | | |
| 3 AMP | 21 | 27 | 30 | 29 | 26 | 23 | 15 | 3 AMP | 4 | 12 | 18 | 31 | 40 | 48 | 41 |
| 6 AMP | 11 | 15 | 17 | 19 | 18 | 16 | 13 | 6 AMP | 4 | 12 | 16 | 26 | 35 | 40 | 35 |
| 10 AMP | 5 | 8 | 10 | 12 | 11 | 11 | 10 | 10 AMP | 4 | 12 | 16 | 26 | 33 | 40 | 32 |
| S MODELS | | | | | | | | | | | | | | | |
| 3 AMP | 21 | 27 | 33 | 40 | 44 | 50 | 32 | 3 AMP | 4 | 12 | 15 | 30 | 48 | 50 | 45 |
| 6 AMP | 12 | 17 | 23 | 32 | 36 | 44 | 30 | 6 AMP | 4 | 12 | 15 | 22 | 42 | 55 | 45 |
| 10 AMP | 5 | 10 | 13 | 23 | 27 | 35 | 27 | 10 AMP | 4 | 12 | 15 | 22 | 42 | 55 | 45 |

| STYLE | DIMENSION 'A' | | DIMENSION B |
|-------|---------------|----------|-------------|
| | UNSHIELDED | SHIELDED | |
| | PS | 1.06 | 1.12 |
| PSL | 1.12 | | 2.201 * |
| PE | 1.12 | 1.12 | 2.201 * |
| PM | 1.06 | 1.12 | 2.13 |
| PSC | 1.06 | 1.12 | 2.52 |
| PSJ | 1.06 | 1.12 | 2.6 |

* FOR PANEL THICKNESS OF 0.031"-0.079" ONLY.
USE 2.213 FOR PANEL THICKNESS OF 0.083"-0.114"

| SHEET 1 OF 2 | | | |
|--------------|--------|---------|-----|
| ECN# | APPRVD | DATE | REV |
| 10-002963 | ELC | 19AUG10 | C |
| 12-015327 | TAM | 22AUG12 | D |

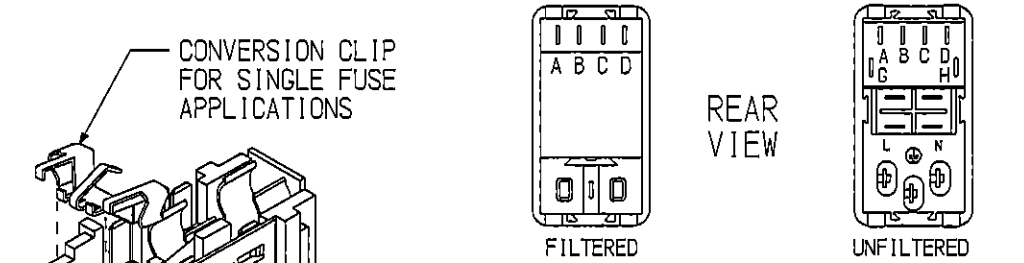
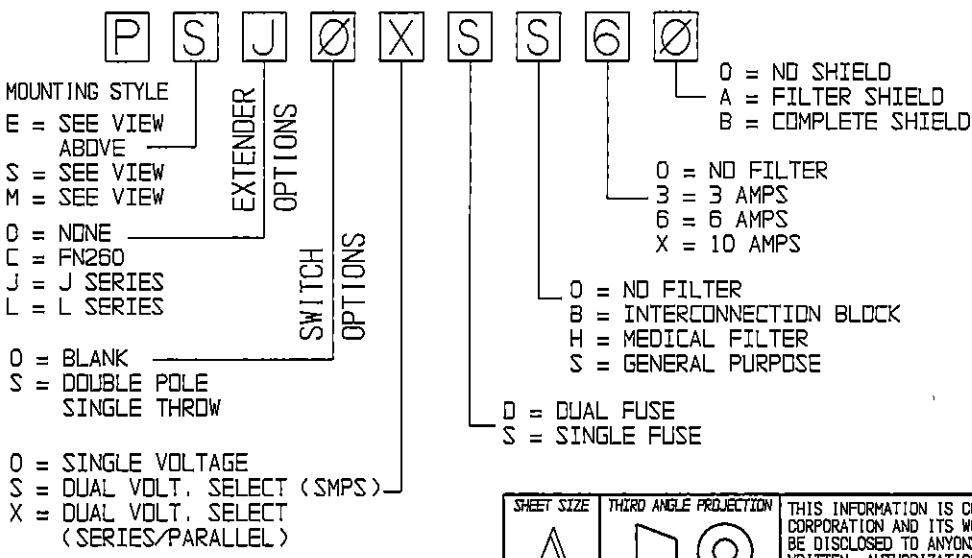
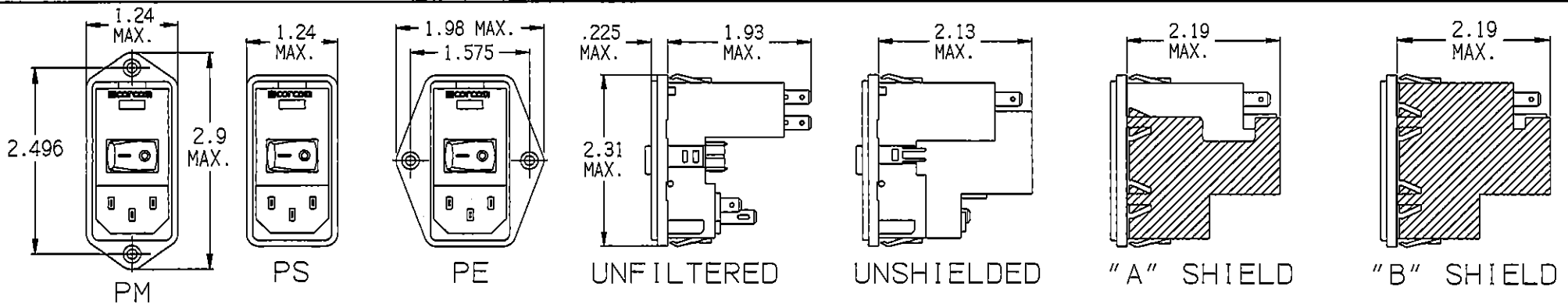
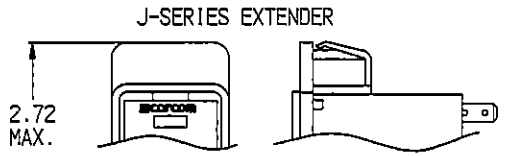
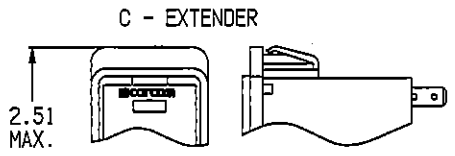
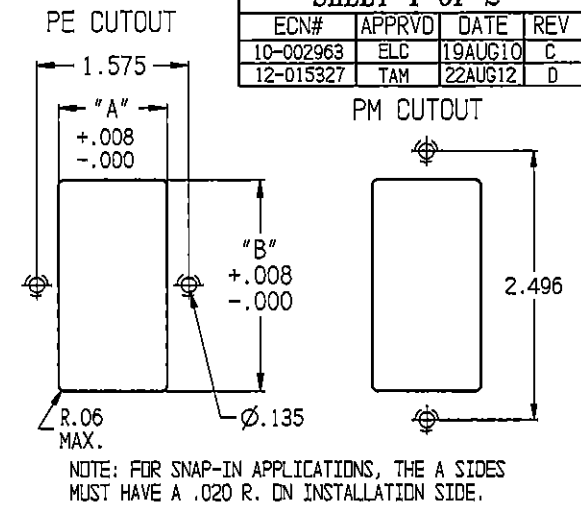

Tyco Electronics
CORCOM PRODUCTS, 620 S. BUTTERFIELD RD. MUNDLEIN IL 60060

CUSTOMER DRAWING
P-SERIES

TYCO ELECTRONICS PART NO.

| | | | |
|------------|--------------|--------------------------|--------|
| SCALE: 1:2 | DATE: 2-4-97 | DRAWING NUMBER: P-SERIES | REV: D |
| DRW. BY: | ORIG: | | |

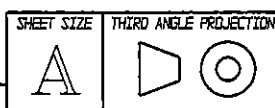

THIS INFORMATION IS CONFIDENTIAL AND PROPRIETARY TO TYCO ELECTRONICS CORPORATION AND ITS WORLDWIDE SUBSIDIARIES AND AFFILIATES. IT MAY NOT BE DISCLOSED TO ANYONE OTHER THAN TYCO ELECTRONICS PERSONNEL, WITHOUT WRITTEN AUTHORIZATION FROM TYCO ELECTRONICS CORPORATION, HARRISBURG, PENNSYLVANIA USA.

SPECIFICATIONS

| | |
|---------------------------|---|
| HIPOT RATING (ONE MINUTE) | |
| LINE TO GROUND: | 1500 VAC |
| LINE TO LINE: | 1450 VDC |
| OPERATING FREQUENCY: | 50/60 Hz |
| RATED VOLTAGE: | 120/250 VAC |
| OPERATING VOLTAGES: | 115/230 VAC |
| SELECTABLE OR FIXED: | SELECTABLE FUSEHOLDER ACCEPTS 1 OR 2 FUSES 1/4" x 1-1/4" OR 5 x 20mm |
| OPERATING AMBIENT TEMP.: | -10°C TO +40°C |
| STORAGE TEMPERATURE: | -40°C TO +85°C |
| HUMIDITY: | 21 DAYS, 40°C @95% RH. |
| CURRENT OVERLOAD TEST: | 6 TIMES I _R FOR 8 SECONDS |



NOTE 1: JUMPERS ARE REQUIRED IF A FILTER OR INTERCONNECTION MODULE IS NOT USED.
 NOTE 2: LOCATION OF OPTIONAL FILTER. JUMPERS ARE REQUIRED IF A FILTER OR INTERCONNECTION MODULE IS NOT USED.

NONFILTERED MODELS

| | |
|---------------------------------|--------------------------------|
| RATED CURRENT; I _R : | 10A @ 120 VAC 10A @ 250 VAC |
|---------------------------------|--------------------------------|

FILTERED MODELS

| | |
|--|---------------------------------|
| MAXIMUM LEAKAGE CURRENT, EACH LINE TO GROUND | |
| @ 120 VAC 60Hz: | H MODELS 2µA S MODELS 0.25m |
| @ 250 VAC 50Hz: | H MODELS 5µA S MODELS 0.50mA |

| | |
|---------------------------------|-----------------------------------|
| RATED CURRENT; I _R : | 3, 6 & 10 AMP MODELS AVAILABLE |
|---------------------------------|-----------------------------------|

GENERAL NOTES:
 CONVERSION CLIP PROVIDED ON FUSEHOLDER FOR SINGLE FUZE MODELS.
 SWITCH: DOUBLE INSULATED RATED FOR 10,000 OPERATIONS AT FULL LOAD.
 51 AMP INRUSH CAPABILITY.
 TERMINALS: FOUR 0.187" x 0.032" QUICK CONNECT TABS
 ONE SOLDER TERMINAL

SAFETY ORGANIZATIONS

THIS FILTER HAS BEEN FORMALLY RECOGNIZED, CERTIFIED OR APPROVED BY THE LISTED AGENCY. THEREFORE, ALL TEST/REQUIREMENTS SPECIFIED IN THE LATEST REVISION OF THE FOLLOWING AGENCY STANDARDS HAVE BEEN MET:

UL RECOGNIZED
 CSA CERTIFIED
 VDE APPROVED



SEE INDIVIDUAL CUSTOMER DRAWINGS FOR OTHER (L AND Z) P-SERIES VERSIONS.

Tyco Electronics
 CORCOM PRODUCTS, 620 S. BUTTERFIELD RD. MUNDELEIN IL 60060

CUSTOMER DRAWING
 P-SERIES

TYCO ELECTRONICS PART NO.

| | | | |
|-----------|--------------|--------------------------|--------|
| SCALE: NA | DATE: 2/4/97 | DRAWING NUMBER: P-SERIES | REV. D |
| DRW. BY: | ORIG: | | |

| | |
|--------------|------------------------|
| SHEET SIZE A | THIRD ANGLE PROJECTION |
|--------------|------------------------|

THIS INFORMATION IS CONFIDENTIAL AND PROPRIETARY TO TYCO ELECTRONICS CORPORATION AND ITS WORLDWIDE SUBSIDIARIES AND AFFILIATES. IT MAY NOT BE DISCLOSED TO ANYONE OTHER THAN TYCO ELECTRONICS PERSONNEL, WITHOUT WRITTEN AUTHORIZATION FROM TYCO ELECTRONICS CORPORATION, HARRISBURG, PENNSYLVANIA USA.

X-ON Electronics

Largest Supplier of Electrical and Electronic Components

Click to view similar products for [AC Power Entry Modules](#) category:

Click to view products by [TE Connectivity](#) manufacturer:

Other Similar products are found below :

[0098.0050](#) [6167.0002](#) [6609100-2](#) [7-6609955-2](#) [FKI2-50-6/M5](#) [FN361-6-06](#) [FN389-4-22](#) [FN9226B-6-02](#) [FN9233S1-10-06](#) [FN9233S1-8-06](#)
[FN9233S1B-8-06](#) [FN9233S1R-1-06](#) [FN9233S1R-12-06](#) [FN9233SB-1-06](#) [FN9233SB-12-06](#) [FN9233SB-8-06](#) [FN9233SR-10-06](#) [FN9244B-15-06HI](#) [FN9244EB-3-06](#) [FN9244EB-8-06](#) [FN9244ER-15-06](#) [FN9244ER-8-06](#) [FN9244ES1-8-06](#) [FN9244ESB-8-06](#) [FN9244R-12-06](#)
[FN9244S1-12-06](#) [FN9244S1R-3-06](#) [FN9244SB-8-06](#) [FN9244SR-6-06](#) [FN9244U-3-06](#) [FN9244U-8-06](#) [8-6609940-2](#) [PE00SSSXB](#) [Fuse-H-EUR-1](#) [Fuse-H-USA-1](#) [PM00XD000](#) [A-0701-HT-H](#) [15EJMS8](#) [1-6609941-2](#) [200JM6-2](#) [CA121003-6](#) [SK-1015\(F1-5\)](#) [161-R3015-E](#) [1-6609153-2](#) [FN323-1-05](#) [FN9233B-8-06](#) [FN9233EB-1-06](#) [FN9233ES1R-10-06](#) [FN9233R-12-06](#) [FN9233S-10-06](#)