

Type RL73 Series

Key Features

Up to 2W @ 70°C

8 chip sizes

Ideal for current detection

Terminal finish –
electroplated 100% matte
Sn

Applications

Communications

Audio

Automotive

Low voltage power
supplies

Power management
applications



TE Connectivity are pleased to offer this thick film chip resistor for current sensing positions. It has a special metal glaze resistive element and a nickel barrier layer beneath the solder to prolong terminal life. Following the developments by semiconductor manufacturers in the production of a range of IC's for battery charge management and low voltage power supplies, the RL73 Series satisfies the demand for a low ohmic shunt resistor to act as a current sensor.

Electrical Characteristics Standard Power

Size	Size	TCR (PPM/°C)	Power rating @ 70°C	Resistance Range (Ω)	Max Operating Current	Packaging			
						TDF	TD	TE	Tape
RL73X1H	0201	±1000	0.05W	R10 – R13	0.70A	1000	5000		Paper
RL73V1H		±600		R15 – R47					
RL73N1H		±300		R51 – R91					
RL73M1E	0402	±400	0.0625W	R05 – R091	1.11A	1000	5000		Paper
RL73N1E		±300		R10 – R47					
RL73K1E		±200		R51 – R91					
RL73V1J	0603	±600	0.1W	R020 – R047	2.23A	1000	5000		Paper
RL73M1J		±400		R051 – R091					
RL73N1J		±300		R10 – R50					
RL73K1J		±200		R51 – R91					
RL73V2A	0805	±600	0.125W	R020 – R047	2.50A	1000	5000		Paper
RL73M2A		±400		R051 – R10					
RL73N2A		±300		R11 – R18					
RL73K2A		±200		R20 – R91					
RL73H2A		±100		R10 – R91	1.11A				

Electrical Characteristics Standard Power (continued)

Size	Size	TCR (PPM/°C)	Power rating @ 70°C	Resistance Range (Ω)	Max Operating Current	Packaging			
						TDF	TD	TE	Tape
RL73V2B	1206	±600	0.25W	R010 – R020	5.00A	1000	5000		Paper
RL73M2B		±400		R022 – R047					
RL73N2B		±300		R051 – R091					
RL73K2B		±200		R10 – R91					
RL73H2B		±100		R10 – R91					
RL73V2E	1210	±600	0.5W	R010 – R020	7.07A	1000	5000		Paper
RL73M2E		±400		R022 – R047					
RL73N2E		±300		R051 – R091					
RL73K2E		±200		R10 – R91					
RL73H2E		±100		R075 – R91					
RL73V2H	2010	±600	0.75W	R010 – R020	8.66A			4000	Embossed Plastic
RL73M2H		±400		R022 – R047					
RL73N2H		±300		R051 – R091					
RL73K2H		±200		R10 – R91					
RL73H2H		±100		R050 – R91					
RL73V3A	2512	±600	1W	R010 – R020	10.0A			4000	Embossed Plastic
RL73M3A		±400		R022 – R047					
RL73N3A		±300		R051 – R091					
RL73K3A		±200		R10 – R91					
RL73H3A		±100		R020 – R91					

Characteristics Electrical – High Power Version - RLP73

Type	Size	TCR (PPM/°C)	Power rating	Resistance Range	Max. Operating current	Packaging			
						TDF	TD	TE	Tape
RLP73M1E	0402	±400	0.125W	R051 – R091	1.56A	1000	5000		Paper
RLP73N1E		±300		R10 – R47					
RLP73K1E		±200		R51 – R91					
RLP73M1J	0603	±400	0.125W	R051 – R091	1.98A	1000	5000		Paper
RLP73N1J		±300		R10 – R47					
RLP73K1J		±200		R51 – R91					
RLP73M2A	0805	±400	0.25W	R051 – R091	2.21A	1000	5000		Paper
RLP73N2A		±300		R10 – R47					
RLP73K2A		±200		R51 – R91					
RLP73V2B	1206	±600	0.5W	R010 – R020	7.07	1000	5000		Paper
RLP73M2B		±400		R022 – R047					
RLP73N2B		±300		R051 – R091					
RLP73K2B		±200		R10 – R91					

Characteristics Electrical – High Power Version - RLP73 (continued)

Type	Size	TCR (PPM/°C)	Power rating	Resistance Range	Max. Operating current	Packaging			
						TDF	TD	TE	Tape
RLP73V2E	1210	±600	0.75W	R010 – R020	8.66A	1000	5000		Paper
RLP73M2E		±400		R022 – R047					
RLP73N2E		±300		R051 – R091					
RLP73K2E		±200		R10 – R91					
RLP73V2H	2010	±600	1W	R010 – R020	10A	1000		4000	Embossed Plastic
RLP73M2H		±400		R022 – R047					
RLP73N2H		±300		R051 – R091					
RLP73K2H		±200		R10 – R91					
RLP73V3A	2512	±600	2W	R010 – R020	14.1A	1000		4000	Embossed Plastic
RLP73M3A		±400		R022 – R047					
RLP73N3A		±300		R051 – R091					
RLP73K3A		±200		R10 – R91					

Operating Voltage= $\sqrt{P \cdot R}$; Overload Voltage= $2.5 \cdot \sqrt{P \cdot R}$; Operating Current= $\sqrt{P/R}$

Maximum operating temperature -55°C to +155°C

Storage Temperature 25±3°C; Humidity < 80%RH

Power Derating curve

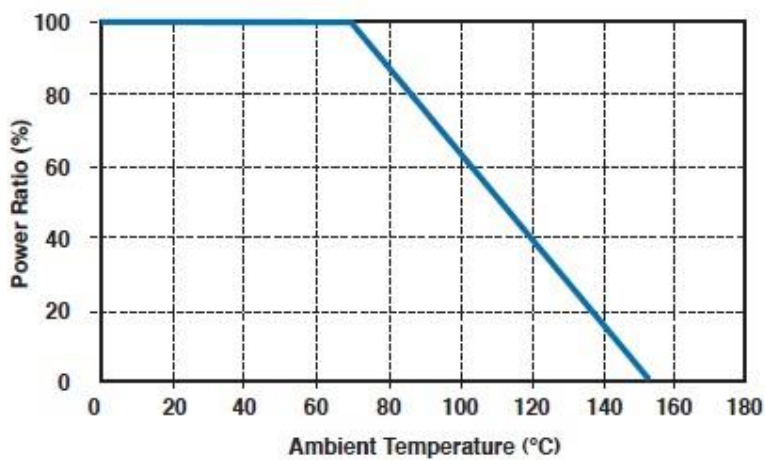

For resistors operated in ambient temperatures above 70°C, power rating must be derated in accordance with this curve.

Construction and dimensions



① Alumina Substrate	④ Edge Electrode (NiCr)	⑦ Resistor Layer (Ag/Pd)
② Bottom Electrode (Ag)	⑤ Barrier Layer (Ni)	⑧ Primary Overcoat (Glass)
③ Top Electrode (Ag-Pd)	⑥ External Electrode (Sn)	⑨ Secondary Overcoat (Epoxy)

Type	Size	L (mm)	W (mm)	T (mm)	D1 (mm)	D2 (mm)	Weight (g) (1000 Pcs.)
RL73	0201 (1H)	0.60±0.03	0.30±0.03	0.23±0.05	0.12±0.05	0.15±0.05	0.18
RL73 / RLP73	0402 (1E)	1.00±0.05	0.50±0.05	0.32±0.10	0.25±0.10	0.20±0.10	0.7
RL73 / RLP73	0603 (1J)	1.60±0.10	0.80±0.10	0.45±0.10	0.30±0.20	0.30±0.20	1.99
RL73 / RLP73	0805 (2A)	2.00±0.10	1.25±0.10	0.55±0.10	0.30±0.20	0.40±0.25	5.3
RL73 / RLP73	1206 (2B)	3.10±0.10	1.55±0.10	0.55±0.10	0.50±0.30	0.40±0.25	8.82
RL73 / RLP73	1210 (2E)	3.10±0.10	2.60±0.15	0.55±0.10	0.50±0.30	0.50±0.25	15.5
RL73 / RLP73	2010 (2H)	5.00±0.10	2.50±0.15	0.60±0.15	0.60±0.30	0.50±0.25	27.03
RL73	2512 (3A)	6.35±0.10	3.10±0.15	0.60±0.10	0.60±0.30	0.55±0.25	43.08
RLP73	2512 (3A) (R010-R099)	6.35±0.20	3.15±0.15	0.74±0.10	0.60±0.30	0.55±0.25	53.08
RLP73	2512 (3A) (R10 -R91)	6.35±0.20	3.15±0.15	0.74±0.10	0.60±0.30	2.10±0.10	53.08

Suggested PCB Layout Plan

Type	A (mm)	B (mm)	C ±0.2mm
0201	0.25	0.30	0.40
0402	0.50	0.50	0.60
0603	0.80	1.00	0.90
0805	1.00	1.00	1.35
1206	2.00	1.15	1.70
1210	2.00	1.15	2.50
2010	3.60	1.40	2.50
2512 (1W)	4.90	1.60	3.20
2512 (2W) ≤99mΩ	4.90	1.60	3.20
2512 (2W) ≥100mΩ	1.0	3.55	3.20

Solder Profile

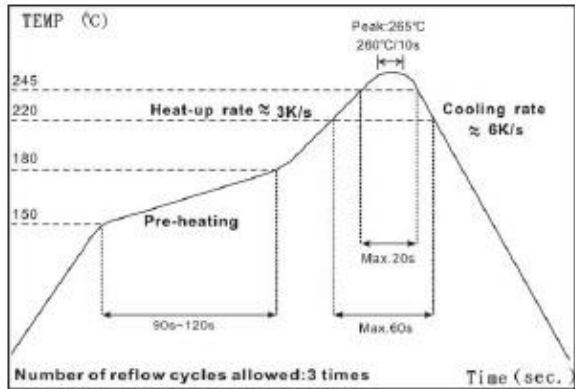

IR Reflow Soldering

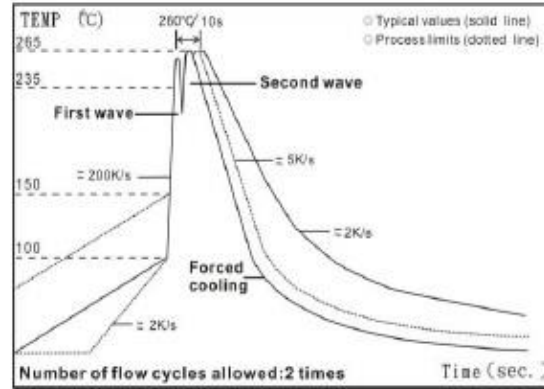

Wave Soldering (Flow Soldering)

- (1) Time of IR reflow soldering at maximum temperature point 260°C : 10s
- (2) Time of wave soldering at maximum temperature point 260°C : 10s
- (3) Time of soldering iron at maximum temperature point 410°C : 5s

Marking Specification

For 0201 and 0402 size resistor – No Marking

1% & 5% 0805/1206/1210/2010/2512 size Resistors – 4 Digit Marking.

Example:

Resistance	47mΩ	75mΩ	15mΩ	750mΩ	820mΩ
Marking	R047	R075	R015	R750	R820

5% for 0603: 3 digits marking in E24

1% for 0603: 3 digits marking with under-line in E96 (if value appears in both E96 and E24 refer to E24)

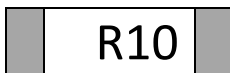

3 digits marking for E24 or R value suffix is zero in E96: R10=100mΩ; R28=280mΩ

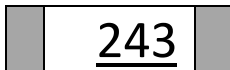

3 digits marking for E96: 243=243mΩ; 511=511mΩ

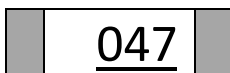

3 digit marking for E24 where value is less than 100mΩ and R value suffix is NOT 0; E.G. R047=47mΩ

Environmental Characteristics

Item	Requirement	Test Method
Temperature Coefficient of Resistance (TCR)	As Spec.	JIS-C-5201-1 4.8 IEC-60115-1 4.8 -55°C ~+125°C, 25°C is the reference temperature
Short Time Overload	$\pm(0.5\%+0.05\Omega)$	JIS C 5201-1 4.13 IEC 60115-1 4.13 RCWV*2.5 or Max. Overload Voltage whichever is lower for 5 seconds
	$\pm(1.0\%+0.05\Omega)$ For High power rating	
Insulation Resistance	$\geq 10G$	JIS-C-5201-1 4.6 IEC-60115-1 4.6 Max. Overload Voltage for 1 minute
Endurance	$\pm(1.0\%+0.05\Omega)$	JIS-C-5201-1 4.25 IEC-60115-1 4.25.1 70 \pm 2°C, RCWV for 1000 hrs with 1.5 hrs "ON" and 0.5 hr off
Damp Heat with Load	$\pm(0.5\%+0.05\Omega)$	JIS-C-5201-1 4.24 IEC-60115-1 4.24 40 \pm 2°C, 90~95% R.H., RCWV for 1000 hrs with 1.5 hrs "ON" and 0.5 hr "OFF"
Dry Heat	$\pm(0.5\%+0.05\Omega)$	JIS-C-5201-1 4.23 IEC-60115-1 4.23.2 at +155°C for 1000 hrs
Bending Strength	$\pm(1.0\%+0.05\Omega)$	JIS-C-5201-1 4.33 IEC-60115-1 4.33 Bending once for 5 seconds with 3mm 2010, 2512 sizes: 2mm
Solderability	95% min. coverage	JIS-C-5201-1 4.17 IEC-60115-1 4.17 245 \pm 5°C for 3 seconds
Resistance to Soldering Heat	$\pm(0.5\%+0.05\Omega)$	S-C-5201-1 4.18 IEC-60115-1 4.18 260 \pm 5°C for 10 seconds
Voltage Proof	No breakdown or flashover	JIS-C-5201-1 4.7 IEC-60115-1 4.7 1.42 times Max. Operating Voltage for 1 minute
Leaching	Individual leaching area $\leq 5\%$ Total leaching area $\leq 10\%$	JIS-C-5201-1 4.18 IEC-60068-2-58 8.2.1 260 \pm 5°C for 30 seconds
Rapid Change of Temperature	$\pm(0.5\%+0.05\Omega)$	JIS-C-5201-1 4.19 IEC-60115-1 4.19 -55°C to +155°C, 5 cycles

RCWV (Rated Continuous Working Voltage) = $\sqrt{P \cdot R}$ or Max. Operating Voltage whichever is lower.

Storage Temperature: 15~28°C; Humidity < 80%RH

Packaging

Packing Quantity and Reel Specification



Size	ØA ±1.0	ØB ±1.0	ØC ±0.7	W ±1.0	T ±1.0	Paper Tape	Embossed Plastic Tape	
0201	178.0	60.0	13.5	9.5	11.5	1000 / 10000	N/A	
0402								
0603								
0805								
1206				13.5	15.5	N/A		1000 / 5000
1210								
2010								
2512	2000							
2512 (2W)								

Paper tape Specification

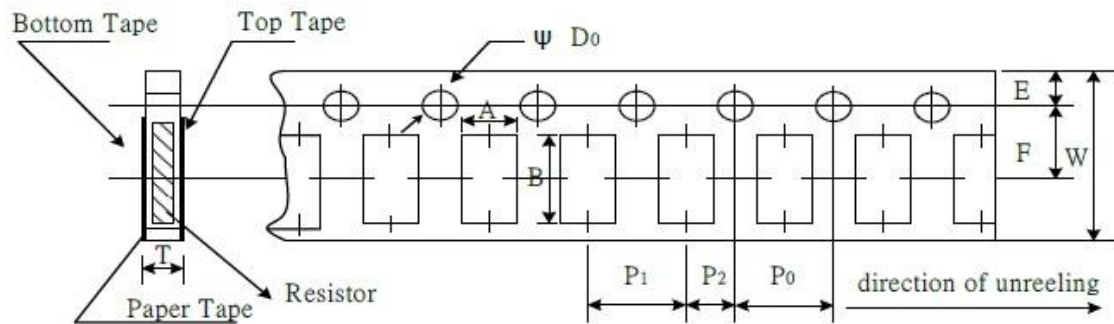

Size	A	B ±0.05	W ±0.20	E ±0.10	F ±0.05	P ₀ ±0.10	P ₁ ±0.05	P ₂ ±0.05	ØD ₀ ±0.1-0	T
0201	0.38±0.05	0.68±0.05	8.00	1.75	3.5	4.00	2.00	2.00	1.50	0.42±0.20
0402	0.65±0.10	1.15±0.10								0.45±0.10
0603	1.10±0.10	1.90±0.10								0.70±0.10
0805	1.60±0.10	2.40±0.20					4.00			0.85±0.10
1206	1.90±0.10	3.50±0.20								
1210	2.90±0.10	3.50±0.20								

Embossed Plastic Tape Specifications



Type	A±0.10	B±0.10	W±0.30	E±0.10	F	P ₀	P ₁	P ₂	ØD ₀	T
2010	2.80	5.50	12.0	1.75	5.5±0.05	4.00±0.05	4.00±0.10	2.00±0.05	1.50±0.10	1.00±0.20
2512	3.50	6.70								
2512 (2W)	3.38	6.68			5.5±0.10	4.00±0.10				

How To Order

RL73	H	2A	R10	F	TD
Common Part	TCR	Size	Value	Tolerance	Packaging
RL73 – Current Sense Resistor – Standard Power	X -1000PPM V - 600PPM N - 300PPM H - 100PPM	1H -0201 1E -0402 1J -0603 2A -0805	0.1 Ohm (100milliOhm) R10	F - ±1% J - ±5%	TDF -1000 REEL TDG – 2000 REEL (2512 2W only) TE - 4000 REEL (2010,2512 only)
RLP73 – Current Sense Resistor – High Power	K - 200PPM M - 400PPM See above for applicability	2B -1206 2E -1210 2H -2010 3A -2512	0.91 Ohm (910milliOhm) R91		TD -5000 REEL (0603~1210) TD- 10000 REEL (0201,0402) See above for applicability

X-ON Electronics

Largest Supplier of Electrical and Electronic Components

Click to view similar products for [Current Sense Resistors - SMD category](#):

Click to view products by [TE Connectivity manufacturer](#):

Other Similar products are found below :

[CRL0603-FW-R700ELF](#) [65709-330JE](#) [PF2512FKF7W0R007L](#) [PR2512FKF7W0R003L](#) [PR2512FKF7W0R005L](#) [PF2512FKF7W0R006L](#)
[PF2512FKF7W0R033L](#) [CD2015FC-0.10-1%](#) [PR2512FKF7W0R004L](#) [RC1005F124CS](#) [RL73K3AR56JTDF](#) [RL7520WT-R001-F](#)
[RL7520WT-R009-G](#) [RL7520WT-R020-F](#) [RLP73N1ER43JTD](#) [LRC-LR2512LF-01-R820J](#) [WR06X104JGLJ](#) [TL2BR01F](#) [65709-330](#) [SP1R12J](#)
[RL7520WT-R039-G](#) [PF1206FRF7W0R02L](#) [RL7520WT-R002-F](#) [RL7520WT-R047-F](#) [KRL1632E-C-R200-F-T5](#) [KRL1632E-C-R200-F-T1](#)
[Y14880R02000B9R](#) [RLP73M1ER051FTDF](#) [RLP73M2AR051FTDF](#) [RLP73M2AR075FTDF](#) [RLP73K2A1R0FTDF](#) [RLP73M1JR051FTDF](#)
[RLP73N1JR47FTDF](#) [SR731ERTTP5R10F](#) [SR731ERTTP100J](#) [SR731ERTTP6R80F](#) [SR731ERTTP4R70F](#) [SR731ERTTP2R20F](#)
[SR731ERTTP3R90F](#) [SR731ERTTP1R00F](#) [SR731ERTTP10R0F](#) [SR731ERTTP2R00F](#) [SR731ERTTP8R20F](#) [SR731ERTTP3R9J](#)
[SR731ERTTP8R2J](#) [SR731ERTTP2R0J](#) [SR731ERTTP4R7J](#) [SR731ERTTP9R1J](#) [SR731ERTTP1R0J](#) [SR731ERTTP2R2J](#)