

# INDUSTRIAL Cable GLANDS & Accessories



# Content

Introduction to Industrial Cable Glands	3-4
Why Raychem RPG	5
Approvals for Industrial Cable Glands	6
A1/A2 Industrial Cable Glands	7
BW Industrial Cable Gland	8
CW Industrial Cable Gland	9
E1W Industrial Cable Gland	10
Nickel Plated Brass Cable Gland	11
Marine Use Watertight Cable Glands	12
Cable Gland Selection Software	12
Ingress Protection Matrix	13
Accessories	14



# Our Company

Raychem RPG (P) Ltd., incorporated in 1989, is a 50:50 joint Venture between TE Connectivity, U.S.A. (formerly Tyco Electronics) and RPG Enterprises, India.

TE Connectivity is a US\$13 Billion global provider for solutions in Network, Transportation, Consumers and Industrial for over 50 years.

RPG Enterprises, an establishment of over 30 years, is one of India's fastest growing business groups with turnover of US\$ 3 Billion. The group has more than fifteen companies managing diverse business interests in the areas of Automotive Tyres, Infrastructure, IT and Specialty including Pharmaceuticals, Power Ancillaries & Plantations.



# INTRODUCTION TO INDUSTRIAL CABLE GLANDS

## Defining Cable Glands

A device designed to permit the entry of a cable, flexible cable or insulated conductor into an enclosure, and which provides sealing and retention. It also provides significant functions such as earthing, bonding, insulation, cable guarding, strain relief or a combination of these. They are mechanical fittings that form part of the electrical installation material.

## Product Design & Construction

Raychem RPG Cable glands are designed for use with all types of electrical power, control, instrumentation, data telecommunications cables & fire rated Cables. They are used as a sealing and termination device to ensure that the characteristics of the enclosure which the cable enters can be maintained adequately.

## Sealing Mechanism

Sealing the cable from dust and moisture ensuring maximum protection to the enclosure is the most significant feature of cable glands. At Raychem RPG, we use the optimum rubber material in the following ways to offer efficient sealing.

Compression sealing is an elastomeric sealing ring that has a V-groove that creates a downward seal on the cable inner bedding, when the same compressive force is equally applied to both sides of the seal. Displacement sealing has a shape in the form of a taper which is gradually pushed ahead into the taper on the gland.

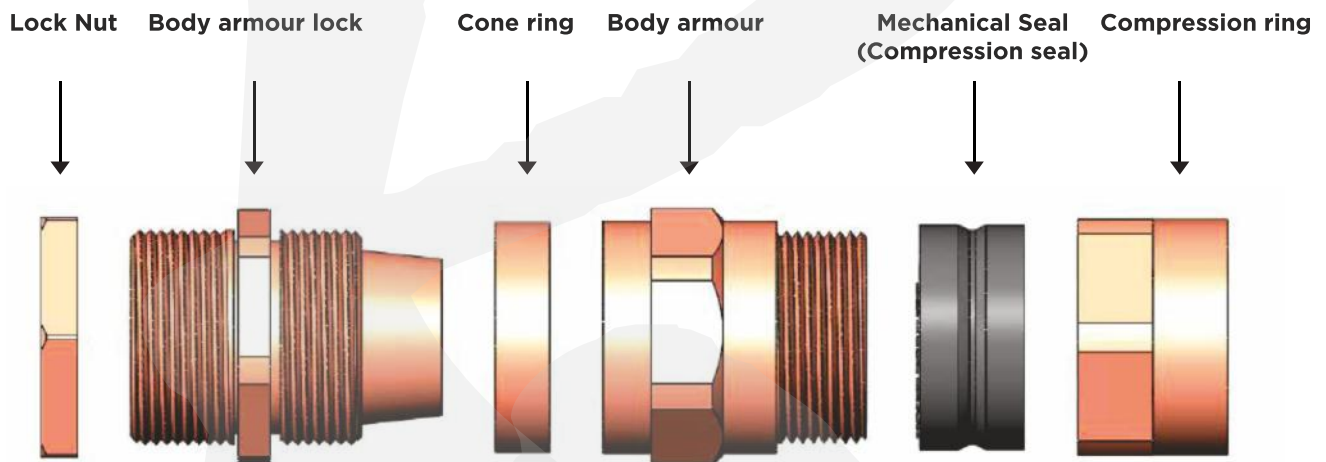

- Body armour houses power cable and supports in clamping cable to junction boxes or external body.
- Mechanical seals (compression & displacement type seals) are used to provide ingress protection to cable gland assembly
- Cone Ring is used to clamp cable armour and support cable in gland body armour lock
- Compression Ring is used to house mechanical seal & provide outer sealing to cable.
- Lock Nut is used to lock cable gland assembly in junction boxes or external body
- Earth Tag is used to maintain earth conductivity from cable to junction boxes or external body
- Shrouds are used to increase ingress protection and protect cable gland assembly from physical damage

## INTRODUCTION TO INDUSTRIAL CABLE GLANDS

### Types Of Industrial Cable Glands

- A2 cable gland
- BW cable gland
- CW cable gland
- E1W cable gland
- Metric thread cable gland
- PG thread cable gland
- Water-tight cable gland
- Nylon cable gland

Cable Gland Primary Code for Unarmoured and Armoured cables.

Code	Definition
A1/A2	For unarmoured cable with an elastomeric or plastic outer sheath, with sealing function between the cable gland. (For A2 – seal protection degree IP66)
B	No Seal
C	Single Outer Seal
E	Double (Inner & Outer Seal)

Cable Gland Secondary Code for Unarmoured and Armoured cables.

Code	Definition
W	Single Wire Armour
Y	Strip Armour
X	Braid
T	Pliable Wire Armour
E	Double (Inner & Outer Seal)

### Compliance Standards

Raychem RPG manufactured mechanical type Cable glands meet the requirements of BS 6121-1:2005; EN 50262-1999: +A1: 2001; +A2:2004; & IEC 62444 / Low voltage directives 2006/95/EC. Raychem RPG Cable Glands are in conformance with IP66 as per British BS EN 60529:1991/A2:2013, European IEC 60529:1989/ A2:2013-Degrees of Protection provided by enclosures (IP Code). The prime purpose is to define levels of sealing effectiveness of electrical enclosures against intrusion from foreign bodies (tools, dirt etc) and moisture.

### Accessories

Raychem RPG Brass cable glands supplies will be with complete kit comprising of the following:

1. Brass Gland
2. Earth Tags
3. PVC / LSF / LSZH Shrouds
4. Sealing Washers - Neoprene or Silicon w.r.t. applications ( Power Cables / FR Cables )

# WHY RAYCHEM RPG

## Quality



At Raychem RPG, quality is a long history of success and recognition. Today the company is one of the Indian businesses to have adjusted and certified its progress according to strict regulatory standards:

- Quality (ISO 9001:2008)
- Environment (ISO 14000)
- Safety (OHSAS 18001)

## Production Control



In order to guarantee our products high quality standards, the production process must be monitored with constant and careful precision. The control phases accompany all the stages of production and often use advanced technology for measurement and detection. We use the cutting edge CNC machine for all our manufacturing operations related to Cable lugs to maintain the world class standard of Raychem RPG.

## Care for Environment



Raychem RPG believes that industrial development can truly respect, and therefore be compatible with the environment. For Raychem RPG, protecting the environment and the people and things around you is an important responsibility that requires constant and immediate consideration. It is a conscious decision which involves believing in the future.

## Competitive Enterprise



One of Raychem RPG's aims is knowing how to offer its users best possible solution in consideration of the quality-price ratio. The fact that thousands of clients all over the world are faithful to Raychem RPG products demonstrates the technical and economic validity of the solution offered.

## Global Capability



The company's sales network is one of its strengths. It enables Raychem RPG to be present on all the main global markets consequently being as closely as possible to the end customer. The company has its presence in South Africa, Qatar, Russia, Kazakhstan and the UK. This direct access to each market allows the Raychem RPG staff to remain inside the market with the advantage of being closer to the client.

## APPROVALS FOR INDUSTRIAL CABLE GLANDS

### Approvals for cable glands

UL tested as per BS EN 50262:1999 +A2:2004 and BS 6121 for

- Cable Retention
- Electrical current test
- Resistance to impact test
- Ingress Protection
- Excess Tightening Torque & Complied Successfully



**Raychem RPG** A2, BW, CW and E1W industrial cable glands are CE Approved as per Applicable Low Voltage directive 2006/95/EC and Applicable Standard IEC 62444:2010.

The CE marking indicates a product's compliance with EU legislation and so enables the free movement of products within the European market. By affixing the CE marking to a product, a manufacturer declares, on his sole responsibility, that the product meets all the legal requirements for the CE marking, which means that the product can be sold throughout the European Economic Area.



**Raychem RPG** A2, BW, CW and E1W Industrial Cable Glands is **RMRS (Russian Maritime Register of Shipping's)** Approved and are suitable for highly corrosive environment and are indicated for the offshore and onshore areas.

RMRS is independent certification body since 1999 RMRS has been recognized by the European Union and acting in accordance with Regulation (EC) 391/2009 and EN 17020.



**Raychem RPG** A2, BW, CW and E1W Industrial Cable Glands successfully completed **RETIE Approval** from Ministry of Mines and Ministry of Energy as per Colombia Rules. RETIE determines the technical conditions to guarantee safety in the processes of product Installed and use throughout the entire national territory.



**Raychem RPG** A2, BW, CW and E1W Industrial Cable Glands successfully completed **GOST R project**.

The GOST R certificate signifies that imported products comply with Russian standards, quality and safety requirements.



**Raychem RPG** A2, BW, CW and E1W Industrial Cable Glands successfully completed the **Kingdom of Saudi Arabia** Type Approval License programme as per KSA Rules. This Type Approval license ensures that products are fully tested in recognized laboratory and a certificate issued before they shipped to Saudi Arabia.



**Raychem RPG** manufactured cable glands & related accessories are **ROHS** complaint in accordance with rohs directive 2011/65/eu & its subsequent ammendment directives & is tested for the presence of Lead (Pb), Cadmium (Cd), Mercury (Hg), Hexavalent chromium (Hex-Cr), Polybrominated biphenyl (PBB), and Polybrominated diphenyl ethers (PBDE) and observed no dangerous substances.



# TECHNICAL DATA SHEET FOR A1/A2 INDUSTRIAL CABLE GLAND

## Raw Material Specification A1/A2 Industrial Cable Gland:

Raychem RPG Manufacturers A1/A2 Industrial Cable Gland as per the requirement of BS EN 50262:1999; +A1:2001; +A2:2004

### Technical Data:

Type	A1/A2	
Design Specification	BS EN 50262:1999	
Gland Sizes	16mm (5/8") - 90 mm (3 1/2")	
Ingress Protection	IP66	
Gland Material	Brass	
Sealing Type	Displacement Type (Single Sealing)	
Operating Temperature	If Neoprene	-40°C to +100°C
	If Silicon	-50°C to +160°C
Sealing Material	Thermoplastic Elastomer	
Sealing Method	Displacement Sealing	
Sealing Area	Cable Outer Sheath	
Finish	Natural Brass or Nickel Plated	
Cable Types	Unarmoured	
Application	Indoor and Outdoor	
Accessories	Lock Nut, Earth Tag & Shrouds, Serrated Washer, Adaptor/Reducer.	

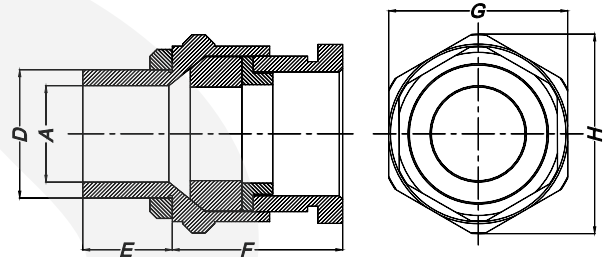

### Product Description:

"Cable GlandType"	Cable Under armour / Bedding Diameter (A)		Max Overall Cable Diameter (A)		Gland Dimensions				
					ISO Entry=Thread		Approx Length from Shoulder (F)	Hexagon Size	
	Min. dia. (mm)	"Max. dia. (mm) Cone ID"	Min. dia. (mm)	"Max. dia. (mm) Entry nut ID"	ISO Entry Thread Diameter (D)	ISO Entry Thread Length (E)		Across Flat (G mm)	Across Corner (H mm)
RRPL A1/A2 16 S	- NA -	- NA -	3.50	6.50	16.00	10.00	20	22.00	24.50
RRPL A1/A2 16 L	- NA -	- NA -	4.00	8.00	16.00	10.00	20	22.00	24.50
RRPL A1/A2 20 S	- NA -	- NA -	8.50	12.00	20.00	15.00	22	24.00	26.00
RRPL A1/A2 20 L	- NA -	- NA -	8.00	13.00	20.00	15.00	22	26.00	29.00
RRPL A1/A2 25 S	- NA -	- NA -	9.00	17.50	25.00	15.00	25	30.00	33.00
RRPL A1/A2 25 L	- NA -	- NA -	12.00	21.00	25.00	15.00	26	33.50	37.00
RRPL A1/A2 32 L	- NA -	- NA -	18.50	26.20	32.00	15.00	30	41.00	45.50
RRPL A1/A2 40 S	- NA -	- NA -	20.00	31.00	40.00	15.00	31	50.00	55.50
RRPL A1/A2 40 L	- NA -	- NA -	23.00	33.00	40.00	15.00	31	50.00	55.50
RRPL A1/A2 50 S	- NA -	- NA -	31.00	38.00	50.00	15.00	33	55.00	60.50
RRPL A1/A2 50 L	- NA -	- NA -	35.00	44.10	50.00	15.00	33	59.50	67.00
RRPL A1/A2 63 S	- NA -	- NA -	39.00	49.30	63.00	15.00	35	70.00	77.00
RRPL A1/A2 63 L	- NA -	- NA -	46.00	53.50	63.00	15.00	35	74.00	80.00
RRPL A1/A2 75 S	- NA -	- NA -	53.00	61.50	75.00	15.00	35	82.00	90.50
RRPL A1/A2 75 L	- NA -	- NA -	60.00	67.40	75.00	15.00	40	84.00	94.00
RRPL A1/A2 90 S	- NA -	- NA -	64.00	72.80	90.00	20.00	50	101.00	114.00
RRPL A1/A2 90 L	- NA -	- NA -	68.00	78.00	90.00	20.00	50	101.00	114.00
RRPL A1/A2 100 L	- NA -	- NA -	78.00	90.00	100.00	25.00	50	119.00	131.00
RRPL A1/A2 115 L	- NA -	- NA -	90.00	103.40	115.00	25.00	54	128.00	142.00

### Raw Material Specification:

Grade of Brass	:	CuZn39Pb3 / IS 319
Copper+Nickel Content	:	56.0 - 59.0 %
Zinc	:	Remainder %
Lead	:	2 - 3.5 %
Iron	:	0.35% Max
Total Impurities	:	0.4 %/ 0.7 %

Note: As per Raychem RPG Quality standards, No Sharp Edges along the length, No dent marks, cracks, line marks acceptable in raw material. Also available in SS 316, SS 304, Non Metallic and Aluminum as per the requirement.

### Product Application:

Raychem RPG A1/A2 type brass indoor and outdoor cable gland is all types of unarmoured cable, providing mechanical cable retention and an environmental seal on the cable outer sheath.





## TECHNICAL DATA SHEET FOR BW 3 PART HEAVY DUTY INDUSTRIAL CABLE GLAND

### Raw Material Specification BW 3 Part Heavy Duty Industrial Cable Gland:

Raychem RPG Manufacturers BW 3 Part Heavy Duty Industrial Cable Gland as per BS6121:Part 1:2005 and meets or supersedes the requirement of BS EN 50262:1999; +A1:2001; +A2:2004.

#### Technical Data:

Type	BW (3 Part)	
Design Specification	BS6121:Part 1: 2005	
Gland Sizes	16mm (5/8") - 90 mm (3 1/2")	
Ingress Protection	IP3X	
Gland Material	Brass	
Sealing Type	No Sealing	
Operating Temperature	If Neoprene	-40 °C to +100 °C
	If Silicon	-50 °C to +160 °C
Armour Clamping	Three Part Armour Lock	
Finish	Natural Brass or Nickel Plated	
Cable Types	Steel Wire Armour (SWA) Aluminium Wire Armour (AWA)	
Application	Dry Indoor	
Accessories	Lock Nut, Earth Tag & Shrouds	

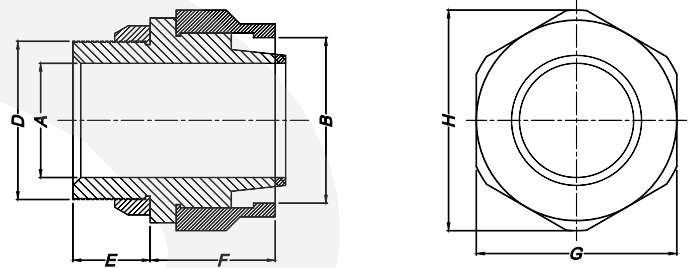

#### Product Description:

"Cable Gland Type"	Cable Under armour / Bedding Diameter (A)		Max Overall Cable Diameter (A)	Gland Dimensions				
	Min. dia. (mm)	"Max. dia. (mm) Cone ID"		ISO Entry Thread		Approx Length from Shoulder (F)	Hexagon Size	
			"Max. dia. (mm) Entry nut ID"	ISO Entry Thread Diameter (D)	ISO Entry Thread Length (E)		Across Flat (G mm)	Across Corner (H mm)
RRPL BW 16 S	- NA -	8.00	12.00	16	10	23	20	23
RRPL BW 16 L	- NA -	8.60	13.50	16	10	23	20	23
RRPL BW 20 S	- NA -	12.60	16.80	20	10	23	22	24
RRPL BW 20 L	- NA -	14.50	21.00	20	10	30	25	28
RRPL BW 25 S	- NA -	19.50	25.00	25	10	30	31	34
RRPL BW 25 L	- NA -	20.50	26.50	25	10	32	32	36
RRPL BW 32 S	- NA -	22.00	29.40	32	10	35	35	40
RRPL BW 32 L	- NA -	26.50	33.00	32	10	36	40	44
RRPL BW 40 S	- NA -	30.00	38.00	40	10	36	46	51
RRPL BW 40 L	- NA -	33.00	41.80	40	15	39	49	55
RRPL BW 50 S	- NA -	40.50	49.00	50	15	40	57	64
RRPL BW 50 L	- NA -	44.10	54.00	50	15	45	62	69
RRPL BW 63 S	- NA -	51.00	61.00	63	15	45	69	78
RRPL BW 63 L	- NA -	56.20	65.50	63	15	50	75	84
RRPL BW 75 S	- NA -	62.00	72.00	75	15	50	82	93
RRPL BW 75 L	- NA -	68.00	77.50	75	15	50	88	99
RRPL BW 90 S	- NA -	78.00	87.00	90	20	55	100	112
RRPL BW 90 L	- NA -	78.50	88.00	90	20	55	112	120

#### Raw Material Specification:

Grade of Brass	:	CuZn39Pb3 / IS 319
Copper+Nickel Content	:	56.0 - 59.0 %
Zinc	:	Remainder %
Lead	:	2 - 3.5 %
Iron	:	0.35% Max
Total Impurities	:	0.4 %/ 0.7 %

#### Product Application:

Raychem RPG BW type brass indoor cable gland is used with all types of Steel Wire Armour (SWA) and Aluminium Wire Armour (AWA) cable providing mechanical cable retention and electrical continuity via armour wire termination. The heavy duty BW design offers the benefit of a longer body to protect the armour wires from impact.



Note: As per Raychem RPG Quality standards, No Sharp Edges along the length, No dent marks, cracks, line marks acceptable in raw material. Also available in SS 316, SS 304, Non Metallic and Aluminum as per the requirement.

# TECHNICAL DATA SHEET FOR CW INDUSTRIAL CABLE GLAND

## Raw Material Specification CW Industrial Cable Gland:

Raychem RPG Manufacturers CW Industrial Cable Gland as per BS6121:Part 1:2005 and meets or supersedes the requirement of BS EN 50262:1999; +A1:2001; +A2:2004.

### Technical Data:

Type	CW	
Design Specification	BS6121:Part 1: 2005	
Gland Sizes	16mm (5/8") - 90 mm (3 1/2")	
Ingress Protection	IP66	
Gland Material	Brass	
Operating Temperature	If Neoprene	-40°C to +100°C
	If Silicon	-50°C to +160°C
Armour Clamping	Three Part Armour Lock	
Sealing Material	Thermoplastic Elastomer	
Sealing Method	Compression Sealing	
Sealing Area	Cable Outer Sheath	
Finish	Natural Brass or Nickel Plated	
Cable Types	Steel Wire Armour (SWA) Aluminium Wire Armour (AWA)	
Application	Indoor & Outdoor	
Accessories	Lock Nut, Earth Tag & Shrouds	

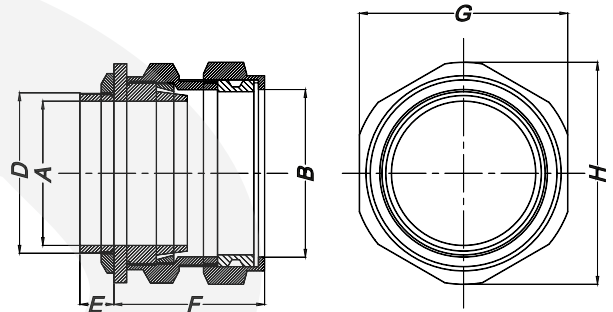

### Product Description:

"Cable GlandType"	Cable Under armour / Bedding Diameter ( A )		Max Overall Cable Diameter ( A )		Gland Dimensions				
	Min. dia. (mm)	"Max. dia. (mm) Cone ID"	Min. dia. (mm)	"Max. dia. (mm) Entry nut ID"	ISO Entry Thread		Approx Length from Shoulder ( F )	Hexagon Size	
					ISO Entry Thread Diameter ( D )	ISO Entry Thread Length ( E )		Across Flat ( G mm )	Across Corner ( H mm )
RRPL CW 16 S	- NA -	9.00	4.00	7.70	16.00	10.00	40	20.50	22.70
RRPL CW 16 L	- NA -	9.00	6.00	12.00	16.00	10.00	40	20.50	22.70
RRPL CW 20 S	- NA -	12.50	9.50	14.50	20.00	10.00	47	22.20	24.20
RRPL CW 20 L	- NA -	14.20	14.00	18.50	20.00	10.00	47	26.20	29.00
RRPL CW 25 S	- NA -	18.50	18.40	23.20	25.00	10.00	50	31.00	34.50
RRPL CW 25 L	- NA -	20.40	19.00	25.50	25.00	10.00	50	36.00	39.20
RRPL CW 32 L	- NA -	27.20	25.50	32.80	32.00	10.00	55	41.00	46.00
RRPL CW 40 S	- NA -	32.00	28.50	35.50	40.00	15.00	60	49.50	55.50
RRPL CW 40 L	- NA -	33.50	32.00	39.00	40.00	15.00	60	49.50	54.50
RRPL CW 50 S	- NA -	40.10	39.00	46.70	50.00	15.00	65	57.00	63.50
RRPL CW 50 L	- NA -	44.50	43.50	51.00	50.00	15.00	65	62.00	69.60
RRPL CW 63 S	- NA -	50.00	47.50	55.60	63.00	15.00	70	73.00	81.00
RRPL CW 63 L	- NA -	56.30	52.00	62.20	63.00	15.00	70	78.00	86.00
RRPL CW 75 S	- NA -	63.10	57.50	70.70	75.00	15.00	75	84.50	95.50
RRPL CW 75 L	- NA -	68.00	63.00	75.50	75.00	15.00	75	91.00	102.20
RRPL CW 90 S	- NA -	77.30	75.50	85.00	90.00	20.00	90	100.00	110.00
RRPL CW 90 L	- NA -	78.70	80.00	88.70	90.00	20.00	90	103.00	114.00

### Raw Material Specification:

Grade of Brass	:	CuZn39Pb3 / IS 319
Copper+Nickel Content	:	56.0 - 59.0 %
Zinc	:	Remainder %
Lead	:	2 - 3.5 %
Iron	:	0.35% Max
Total Impurities	:	0.4 %/ 0.7 %

### Product Application:

Raychem RPG CW type brass indoor cable gland is used with all types of Steel Wire Armour (SWA) and Aluminium Wire Armour (AWA) cable providing mechanical cable retention and electrical continuity via armour wire termination.



Note : As per Raychem RPG Quality standards, No Sharp Edges along the length, No dent marks, cracks, line marks acceptable in raw material.  
Also available in SS 316, SS 304, Non Metallic and Aluminum as per the requirement.

## TECHNICAL DATA SHEET FOR E1W INDUSTRIAL CABLE GLAND

### Raw Material Specification E1W Industrial Cable Gland:

Raychem RPG Manufacturers E1W Industrial Cable Gland as per BS6121:Part 1:2005 and meets or supersedes the requirement of BS EN 50262:1999; +A1:2001; +A2:2004.

### Technical Data:

Type	E1W	
Design Specification	BS6121:Part 1: 2005	
Gland Sizes	16mm (5/8") - 90 mm (3 1/2")	
Ingress Protection	IP66	
Gland Material	Brass	
Operating Temperature	If Neoprene	-40°C to +100°C
	If Silicon	-50°C to +160°C
Armour Clamping	Three Part Armour Lock	
Sealing Material	Thermoplastic Elastomer	
Sealing Method	"Double Compression Sealing (Compression Sealing on Outer Cable Sheath, Compression Sealing on Inner Cable Sheath)"	
Sealing Area	Cable Outer Sheath	
Finish	Natural Brass or Nickel Plated	
Cable Types	Steel Wire Armour (SWA) Aluminium Wire Armour (AWA)	
Application	Indoor & Outdoor	
Accessories	Lock Nut, Earth Tag & Shrouds, Serrated Washer, Adaptor/Reducer	

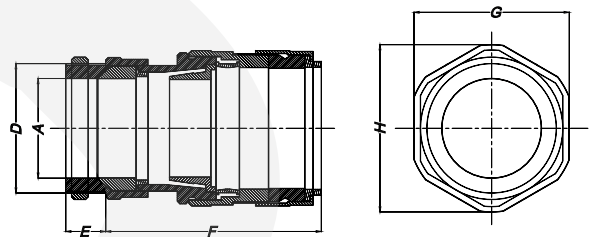

### Product Description:

"Cable Gland Type"	Cable Under armour / Bedding Diameter ( A )		Max Overall Cable Diameter ( B )		Gland Dimensions				
	Min. dia. (mm)	"Max. dia. (mm) Cone ID"	Min. dia. (mm)	"Max. dia. (mm) Entry nut ID"	ISO Entry Thread		Approx Length from Shoulder ( F )	Hexagon Size	
					ISO Entry Thread Diameter ( D )	ISO Entry Thread Length ( E )		Across Flat ( G mm )	Across Corner ( H mm )
RRPL E1W 16 L	6.30	8.60	8.00	13.50	M16	15.00	40	22.00	24.00
RRPL E1W 20 S	8.00	10.50	8.30	15.00	M20	15.00	45	22.00	24.00
RRPL E1W 20 L	11.20	14.00	14.50	19.50	M20	15.00	45	27.00	30.00
RRPL E1W 25 S	13.20	18.50	18.00	21.50	M25	15.00	50	31.00	35.00
RRPL E1W 25 L	14.50	20.30	18.80	25.50	M25	15.00	50	35.00	39.00
RRPL E1W 32 L	19.00	26.00	23.00	31.30	M32	15.00	55	44.00	48.00
RRPL E1W 40 S	25.00	29.00	31.50	40.10	M40	15.00	60	51.50	57.50
RRPL E1W 40 L	26.40	32.50	33.40	41.90	M40	15.00	60	51.50	57.50
RRPL E1W 50 S	26.00	39.60	37.80	47.40	M50	15.00	65	59.00	65.00
RRPL E1W 50 L	36.80	43.40	39.00	49.30	M50	15.00	65	64.50	72.00
RRPL E1W 63 S	45.50	53.00	49.30	58.00	M63	18.00	70	70.00	77.00
RRPL E1W 63 L	49.50	55.00	53.00	65.00	M63	18.00	70	78.00	87.50
RRPL E1W 75 S	56.10	61.00	61.50	68.60	M75	20.00	76	84.00	92.50
RRPL E1W 75 L	55.00	66.50	66.40	78.50	M75	20.00	79	95.00	108.00
RRPL E1W 90 L	66.50	73.50	72.00	88.00	M90	20.00	96	105.00	122.00

### Raw Material Specification:

Grade of Brass	:	CuZn39Pb3 / IS 319
Copper+Nickel Content	:	56.0 - 59.0 %
Zinc	:	Remainder %
Lead	:	2 - 3.5 %
Iron	:	0.35% Max
Total Impurities	:	0.4 %/ 0.7 %

Note As per Raychem RPG Quality standards, No Sharp Edges along the length, No dent marks, cracks, line marks acceptable in raw material. Also available in SS 316, SS 304, Non Metallic and Aluminum as per the requirement.

### Product Application:

Raychem RPG E1W type brass indoor and outdoor cable gland is used with all types of Sheathed and Steel Wire Armour (SWA) cable providing an environmental seal on the cable inner sheath and cable outer sheath. The cable gland provides mechanical cable retention and electrical continuity via the armour termination and also earth bonding of the inner lead covering or lead sheath. Separate tightening actions for the inner displacement seal and the armour termination allows maximum control over the pressure applied to the cable inner covering.



## NICKEL PLATED BRASS GLAND - IP 68 RATING - METRIC THREAD

This metal gland is unique product different than traditional metal Glands and is perfect gland for unarmoured PVC, XLPE & other synthetic cables.

### Features:

- Ip68 Rating-the highest possible
- Superior Strain Relief
- Nickel plated brass for corrosion protection
- Fully insulated by plastic insert.
- Neoprene seal for fluid tightness.

Mounting Thread		Min.	Max.	Width	Product Code
A Dia. (mm)	B Leng. (mm)	Cab. Ran. (mm)	Cab. Ran. (mm)	A/F (mm)	
12.0	5.0	3.0	6.5	14.0	RRPLMT - 12
16.0	5.5	5.5	10.0	17.0	RRPLMT - 16
20.0	6.0	8.0	13.0	22.0	RRPLMT - 20
25.0	7.0	11.0	18.0	30.0	RRPLMT - 25
32.0	8.0	15.0	21.0	34.0	RRPLMT - 32
40.0	8.0	19.0	27.0	44.0	RRPLMT - 40
50.0	9.0	26.0	35.0	55.0	RRPLMT - 50
63.0	10.0	39.0	48.0	66.0	RRPLMT - 63

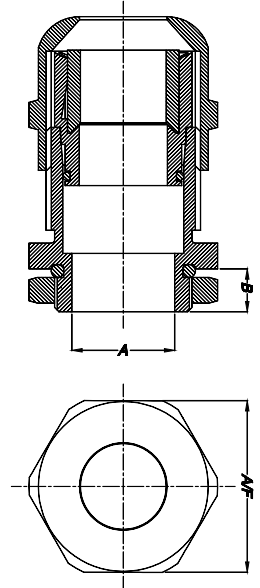

## NICKEL PLATED BRASS GLAND-IP 68 RATING-PG THREAD

Mounting Thread		Min.	Max.	Width	Product Code
A Dia. (mm)	B Leng. (mm)	Cable Dia. (mm)	Cable Dia. (mm)	A/F (mm)	
7.0	5.0	3.0	6.5	14.0	RRPLPG - 7
9.0	6.0	5.5	10.0	17.0	RRPLPG - 9
11.0	6.0	5.5	10.0	20.0	RRPLPG - 11
13.5	6.5	8.0	13.0	22.0	RRPLPG - 13.5
16.0	6.5	8.0	14.0	24.0	RRPLPG - 16
21.0	7.0	11.0	18.0	30.0	RRPLPG - 21
29.0	8.0	16.0	23.0	40.0	RRPLPG - 29
36.0	9.0	21.0	29.0	50.0	RRPLPG - 36
42.0	10.0	26.0	35.0	57.0	RRPLPG - 42
48.0	10.0	27.0	38.0	66.0	RRPLPG - 48

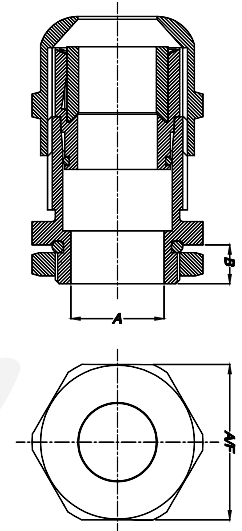

### WIPING GLAND

1. Manufactured from heavy duty brass
2. Made as per customer drawings and specification



### PRODUCT FAMILY



## MARINE-USE WATERTIGHT CABLE GLANDS

### MARINE-USE WATERTIGHT CABLE GLANDS

Material : Brass, Finish : Nickel Plated  
 No. of Parts: Body, Clamping Gland, Lock Nut, Two Brass Washers, Rubber Thread Seal, Rubber Inner Compression Rign.

Piper Thread A	Gland ID in mm	Rubber ID C	Locknut OD in mm D	Gland OD in mm L	Total Length	Product Code
PF 3/8"	10	8	28	22	38	RRPLMG - 10
PF 1-2"	15	10	31.5	28	42	RRPLMG - 15
PF 3/4"	20	13	37	33.5	46	RRPLMG - 20
PF 1"	25	15	45	42	52	RRPLMG - 25
PF 1 1/4"	30	24	46	49.5	57	RRPLMG - 30
PF 1 1/2"	40	30	63	55	65	RRPLMG - 35
PF 1 1/2"	40	34	63	55	65	RRPLMG - 40
PF 2"	45	38	77	69	73	RRPLMG - 45
PF 2"	50	44	77	69	73	RRPLMG - 50
PF 2 1/2"	55	48	96	85	83	RRPLMG - 55
PF 2 1/2"	60	54	28	85	83	RRPLMG - 60
PF 3"	65	60	112	100	95	RRPLMG - 65
PF 3"	70	64	112	100	95	RRPLMG - 70

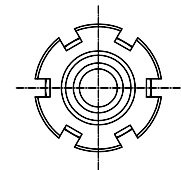
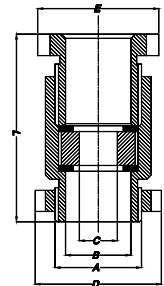

## CABLE GLAND SELECTION SOFTWARE





Raychem RPG has introduced cable gland selection software and designers now can find the right gland for their requirement. Operators may either specify environmental requirements and cable characteristics or use cable manufacturer's codes and product descriptions to access the data sheet for the relevant product.

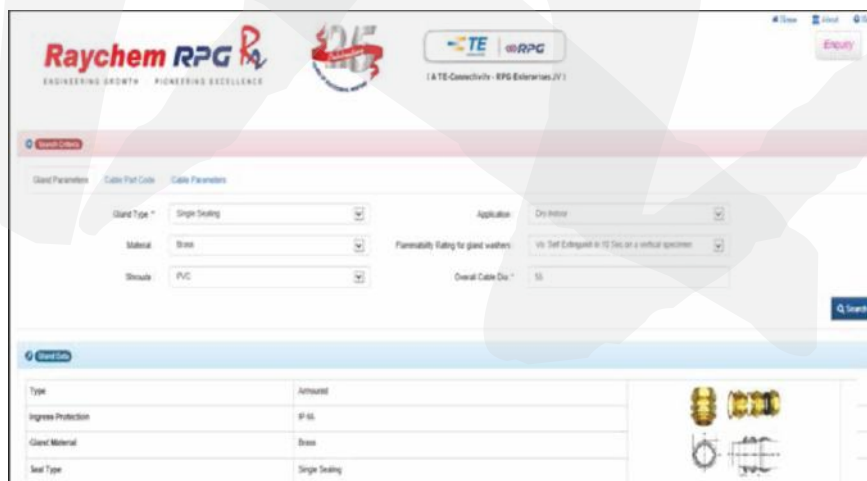

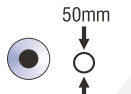
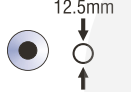
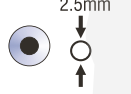

### Reference Standard:

- Internationally followed standard
- BS 6121-1: 2005,
- EN 50262-1999: +A1: 2001; +A2:2004 & IEC 62444
- Low voltage directives 2006/95/EC

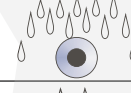
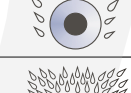

## INGRESS PROTECTION MATRIX

First Digit	Protection against Solid Foreign Objects and Access to Hazardous Parts		
	Illustration	Method	Explanation
0	-	Non-Protected	Non-Protected
1		Protected against solid foreign objects of 50mm diameter and greater.	Protected against access to hazardous parts with the back of a hand
2		Protected against solid foreign objects of 12.5 mm diameter and greater.	Protected against access to hazardous parts with the back of a hand
3		Protected against solid foreign objects of 2.5 mm diameter and greater.	Protected against access to hazardous parts with the back of a hand
4		Protected against solid foreign objects of 1.0 mm diameter and greater.	Protected against access to hazardous parts with the back of a hand
5		Dust-protected	Protected against access to hazardous parts with the back of a hand
6		Dust-tight	Protected against access to hazardous parts with the back of a hand

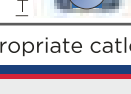
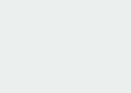
Second Digit	Protection against Liquids	
	Illustration	Method
0	-	Non-Protected
1		Protected against drop of water falling vertically
2		Protected against drop of water falling at up to 15 from the vertically
3		Protected against spraying water at upto 60 from the vertically
4		Protected against splashing water from all direction
5		Protected against jet of water from all direction
6		Protected against jet of water of similar force to heavy seas
7		Protected against the effects of immersion
8		Protected against protonged effects of immersion under pressure to a specified dept

Please refer to appropriate catalogue pages for specific ingress Protection rating according to their design and construction.

## ACCESSORIES

### Adapter & Reducers



Material: Brass, Aluminum

**Features:**

- Designed to provide flexibility when there is conflict between the type of size of cable gland thread and cable entry hole in the equipment.
- Available in standard sizes from M16 to M100.
- Thread conversions available in METRIC, NPT, BSP, PG, IMPERIAL NPSM.

Material: Brass, Aluminum & Copper

**Features:**

- Means of connection or an earth bond around the cable gland.
- Available in various shapes and in standard sizes.
- Ensures earth continuity between the electrical equipment & the gland.
- Can be coated or plated as per Customer Specification.

### Earthing Tag



Metric	Product Code
M16	RRPL ET - 16
M20	RRPL ET - 20
M25	RRPL ET - 25
M32	RRPL ET - 32
M50	RRPL ET - 50

Size	Product Code
M63	RRPL ET - 63
M75	RRPL ET - 75
M80	RRPL ET - 80
M90	RRPL ET - 90
M100	RRPL ET - 100

Material: Brass, Aluminum & Galvanized Steel

**Features:**

- Used in fastening glands to the gland plate.
- Available in Metric, Imperial, NPT, BSPT, BSP & PG.

### Lock Nut



Sizes: 16mm to 90mm

Metric	Product Code
16mm or 5/8"	RRPL LN - 16
20mm or 3/4"	RRPL LN - 20
25mm or 1"	RRPL LN - 25
32mm or 1.1/4"	RRPL LN - 32
40mm or 1.1/2"	RRPL LN - 40

Metric	Product Code
50mm or 2"	RRPL LN - 50
63mm or 2. 1/2"	RRPL LN - 63
75mm or 3"RRPL LN - 75	RRPL LN - 25
90mm or 3.1/2"	RRPL LN - 90
40mm or 1.1/2"	RRPL LN - 40

### Shrouds : PVC, LSF & LSZH



Material : High Grade Poly Vinyl Chloride and Low Smoke and Low Flammable compound and Low Smoke Zero Halogen.

**Features:**

- Provide additional protection protection & enhances IP rating of the Gland Terminals.
- Effective solution to weather and corrosion protection of a Cable Gland.
- Available in same gland size compatible to each size of the Cable Gland.
- The arrow end of the sleeve can be readily cut with a knife, enabling it to be slipped over a wide range of cable diameters and assists ease of installations.



## **Raychem RPG (P) Ltd.**

### **Corporate Office**

RPG House, 463, Dr. A. B. Road, Worli, Mumbai - 400030

Tel. : +91 22 24937485 / 24937486

Fax : +91 22 24938879

### **International Business Division (IBD) - EBU**

1,62, M.G. Rd., Near Bharat Petroleum Pump,

Off. Western Express Highway, P. Satavali, Bassein, Taluka Vasai, Dist. Palghar

Tel. : +91 250 3057500

Fax : +91 250 2480046

Email : [cableglands@raychemrpg.com](mailto:cableglands@raychemrpg.com)

[www.raychemrpg.com](http://www.raychemrpg.com)



(A TE-Connectivity - RPG Enterprises JV)

Copyright 2017

All Rights Reserved to Raychem RPG (P) Limited  
V.012017



## X-ON Electronics

Largest Supplier of Electrical and Electronic Components

*Click to view similar products for [Cable Glands, Strain Reliefs & Cord Grips](#) category:*

*Click to view products by [TE Connectivity](#) manufacturer:*

Other Similar products are found below :

[120-116-1-1-20BP](#) [120-116-1-1-32BE](#) [120-117-40](#) [120-123-14](#) [120-123-16](#) [120-125-16](#) [120-125-16R](#) [120-125-16Y](#) [120-125-24Y](#) [120-125-28](#) [120-125-28R](#) [120-125-32](#) [120-125-32R](#) [120-125-40](#) [120-125-56](#) [120-126-14](#) [120-126-16](#) [120-126-20](#) [120-126-20BL](#) [120-126-20R](#) [120-126-24](#) [120-126-28](#) [120-126-32](#) [120-126-40BL](#) [120-116-1-1-06BP-509](#) [120-116-1-1-06CP](#) [120-116-1-1-16BE](#) [120-116-1-1-28BP](#) [120-123-20](#) [120-123-24](#) [120-123-32](#) [120-125-20](#) [120-125-20Y](#) [120-125-24](#) [120-125-24R](#) [120-125-28Y](#) [120-126-14BL](#) [120-126-16R](#) [120-126-16Y](#) [120-126-24BL](#) [120-126-28BL](#) [120-126-32BL](#) [120-126-40](#) [120-126-48](#) [120-126-48BL](#) [1300980012](#) [1300980105](#) [DBZM-6828](#) [1498](#) [15190-103 R2](#)